

具有 14 位、9GSPS DAC 和 14 位、3GSPS ADC 的 AFE7422 双通道射频采样 AFE

1 特性

- 两通道、14 位 9GSPS DAC
 - 信号带宽高达 1200MHz
 - 每通道 1 个 DSA 调节输出功率
- 两通道、14 位 3GSPS ADC
 - 信号带宽高达 1500MHz
 - NSD: -151dBFS/Hz
 - $f_{IN} = 2.6\text{GHz}$ 、-3dBFS 时的交流性能
 - SNR: 55dBFS
 - SFDR: 73dBc HD2 和 HD3
 - SFDR: 91dBc (最严重毛刺)
 - 每通道 2 个 DSA 扩展动态范围
 - 射频和数字功率检测器
- 射频频率范围: 10MHz 至 6GHz
- 快速跳频 < 1 μ s
- 接收数字信号路径:
 - 每个 ADC 连接可旁路的四通道 DDC
 - 每个 DDC 有 3 个相位同调 32 位 NCO
 - 抽取率: 2 倍至 32 倍
- 发送数字信号路径:
 - 每个带有 32 位 NCO 的 DAC 连接四通道 DUC
 - 插值率: 6 倍至 36 倍
 - Sin(x)/x 校正和可配置延迟
 - 功率放大器保护 (PAP)
- JESD204B 接口:
 - 8 个高达 15Gbps 的收发器
 - 子类 1 多芯片同步
- 时钟:
 - 具有旁路选项的内部 PLL 和 VCO
 - 利用时钟分频器产生最高为 3GHz 的时钟输出
- DAC 功耗: 9GSPS 时为 1.8W/ch
- ADC 功耗: 3GSPS 时为 1.9W/ch
- 封装: 17mm x 17mm FC BGA, 0.8mm 间距

2 应用

- 相控阵雷达
- 信号情报和电子情报
- 通信设备和测试仪
- 宽带数字转换器和波形发生器

3 说明

AFE7422 是具有 14 位 9GSPS DAC 和 14 位 3GSPS ADC 的双通道宽频带射频采样模拟前端 (AFE)。可在高达 6GHz 的射频下工作, 此器件支持直接射频采样到 C 频带, 无需其他频率转换阶段。密度和灵活性的改进实现了对高通道数、多任务系统的支持。

DAC 信号路径支持插值和数字上变频选项, 提供高达 1200MHz 信号带宽。差分输出路径包括支持输出功率调优的数字步进衰减器 (DSA)。

每个 ADC 输入路径包括一个双通道 DSA 和射频数字功率检测器。灵活的抽取选项提供数据带宽优化, 并且抽取旁路模式也可用于最大信号带宽。

8 通道 (8 TX + 8 RX) 子类 1 兼容性 JESD204B 接口运行速度高达 15Gbps。可旁路片上 PLL 通过可选时钟输出简化时钟运行。

器件信息(1)

器件型号	封装	封装尺寸 (标称值)
AFE7422	FCBGA (400)	17.00mm x 17.00mm

(1) 如需了解所有可用封装, 请参阅数据表末尾的封装选项附录。

功能框图

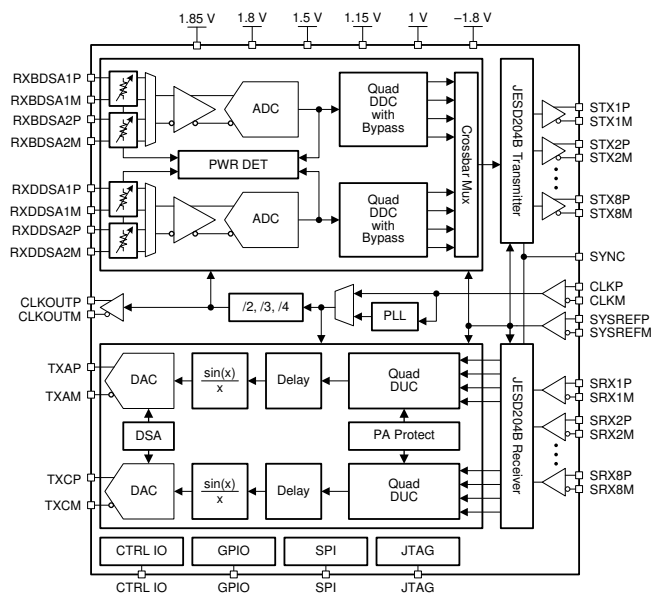

4 修订历史记录

注：之前版本的页码可能与当前版本有所不同。

Changes from Original (October 2018) to Revision A

Page

-
- 已更改 将状态从预告信息改为了生产数据 1
-

5 器件和文档支持

5.1 接收文档更新通知

要接收文档更新通知，请导航至 TI.com.cn 上的器件产品文件夹。单击右上角的 [通知我](#) 进行注册，即可每周接收产品信息更改摘要。有关更改的详细信息，请查看任何已修订文档中包含的修订历史记录。

5.2 社区资源

下列链接提供到 TI 社区资源的连接。链接的内容由各个分销商“按照原样”提供。这些内容并不构成 TI 技术规范，并且不一定反映 TI 的观点；请参阅 TI 的 [《使用条款》](#)。

TI E2E™ 在线社区 [TI 的工程师对工程师 \(E2E\) 社区](#)。此社区的创建目的在于促进工程师之间的协作。在 e2e.ti.com 中，您可以咨询问题、分享知识、拓展思路并与同行工程师一道帮助解决问题。

设计支持 [TI 参考设计支持](#) 可帮助您快速查找有帮助的 E2E 论坛、设计支持工具以及技术支持的联系信息。

5.3 商标

E2E is a trademark of Texas Instruments.
All other trademarks are the property of their respective owners.

5.4 静电放电警告



ESD 可能会损坏该集成电路。德州仪器 (TI) 建议通过适当的预防措施处理所有集成电路。如果不遵守正确的处理措施和安装程序，可能会损坏集成电路。

ESD 的损坏小至导致微小的性能降级，大至整个器件故障。精密的集成电路可能更容易受到损坏，这是因为非常细微的参数更改都可能会导致器件与其发布的规格不相符。

5.5 术语表

[SLYZ022](#) — *TI* 术语表。

这份术语表列出并解释术语、缩写和定义。

6 "机械、封装和可订购信息

以下页面包含机械、封装和可订购信息。这些信息是指定器件的最新可用数据。数据如有变更，恕不另行通知，且不会对此文档进行修订。如需获取此数据表的浏览器版本，请查阅左侧的导航栏。

PACKAGING INFORMATION

Orderable Device	Status (1)	Package Type	Package Drawing	Pins	Package Qty	Eco Plan (2)	Lead finish/ Ball material (6)	MSL Peak Temp (3)	Op Temp (°C)	Device Marking (4/5)	Samples
AFE7422IABJ	ACTIVE	FCBGA	ABJ	400	90	RoHS & Green	SNAGCU	Level-3-260C-168 HR	-40 to 85	AFE7422I	Samples
AFE7422IALK	ACTIVE	FCBGA	ALK	400	90	Non-RoHS & Green	Call TI	Level-3-220C-168 HR	-40 to 85	AFE7422IZ	Samples

(1) The marketing status values are defined as follows:

ACTIVE: Product device recommended for new designs.

LIFEBUY: TI has announced that the device will be discontinued, and a lifetime-buy period is in effect.

NRND: Not recommended for new designs. Device is in production to support existing customers, but TI does not recommend using this part in a new design.

PREVIEW: Device has been announced but is not in production. Samples may or may not be available.

OBSOLETE: TI has discontinued the production of the device.

(2) **RoHS:** TI defines "RoHS" to mean semiconductor products that are compliant with the current EU RoHS requirements for all 10 RoHS substances, including the requirement that RoHS substance do not exceed 0.1% by weight in homogeneous materials. Where designed to be soldered at high temperatures, "RoHS" products are suitable for use in specified lead-free processes. TI may reference these types of products as "Pb-Free".

RoHS Exempt: TI defines "RoHS Exempt" to mean products that contain lead but are compliant with EU RoHS pursuant to a specific EU RoHS exemption.

Green: TI defines "Green" to mean the content of Chlorine (Cl) and Bromine (Br) based flame retardants meet JS709B low halogen requirements of <=1000ppm threshold. Antimony trioxide based flame retardants must also meet the <=1000ppm threshold requirement.

(3) MSL, Peak Temp. - The Moisture Sensitivity Level rating according to the JEDEC industry standard classifications, and peak solder temperature.

(4) There may be additional marking, which relates to the logo, the lot trace code information, or the environmental category on the device.

(5) Multiple Device Markings will be inside parentheses. Only one Device Marking contained in parentheses and separated by a "-" will appear on a device. If a line is indented then it is a continuation of the previous line and the two combined represent the entire Device Marking for that device.

(6) Lead finish/Ball material - Orderable Devices may have multiple material finish options. Finish options are separated by a vertical ruled line. Lead finish/Ball material values may wrap to two lines if the finish value exceeds the maximum column width.

Important Information and Disclaimer:The information provided on this page represents TI's knowledge and belief as of the date that it is provided. TI bases its knowledge and belief on information provided by third parties, and makes no representation or warranty as to the accuracy of such information. Efforts are underway to better integrate information from third parties. TI has taken and continues to take reasonable steps to provide representative and accurate information but may not have conducted destructive testing or chemical analysis on incoming materials and chemicals. TI and TI suppliers consider certain information to be proprietary, and thus CAS numbers and other limited information may not be available for release.

In no event shall TI's liability arising out of such information exceed the total purchase price of the TI part(s) at issue in this document sold by TI to Customer on an annual basis.

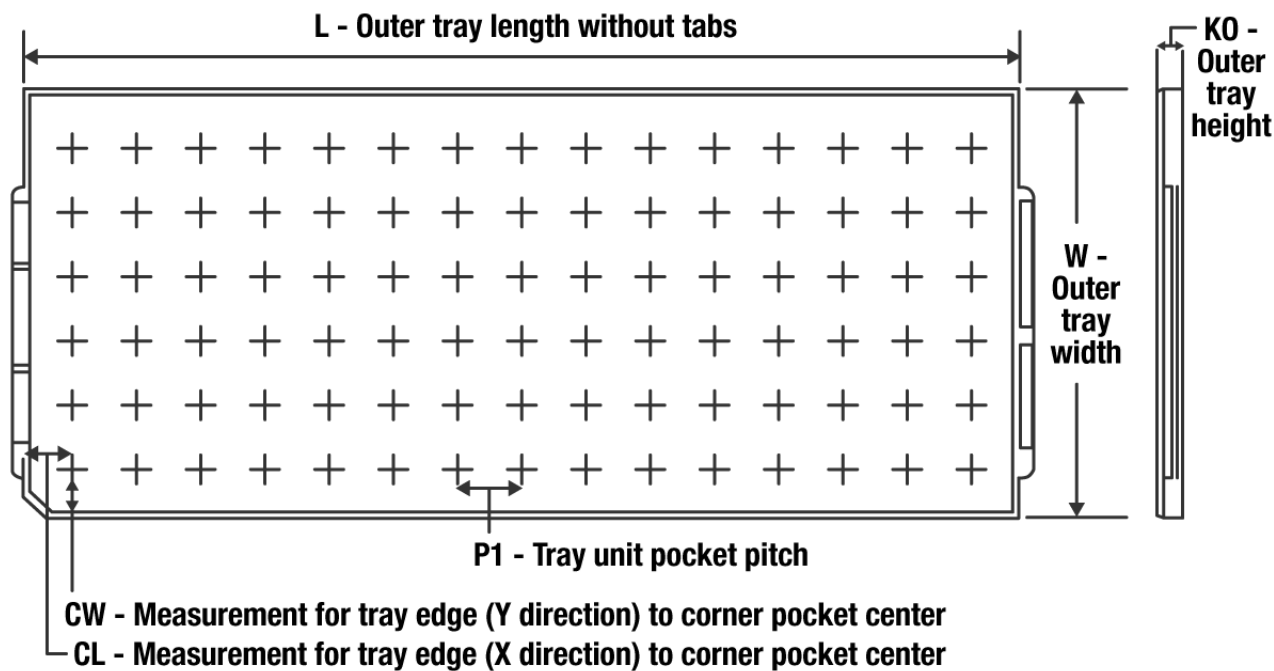
TRAY

Chamfer on Tray corner indicates Pin 1 orientation of packed units.

*All dimensions are nominal

Device	Package Name	Package Type	Pins	SPQ	Unit array matrix	Max temperature (°C)	L (mm)	W (mm)	K0 (µm)	P1 (mm)	CL (mm)	CW (mm)
AFE7422IABJ	ABJ	FCBGA	400	90	6 x 16	150	315	135.9	7620	19.5	21	19.2
AFE7422IALK	ALK	FCBGA	400	90	6 x 16	150	315	135.9	7620	19.5	21	19.2

ABJ0400A

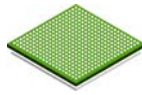

PACKAGE OUTLINE

FCBGA - 2.65 mm max height

BALL GRID ARRAY

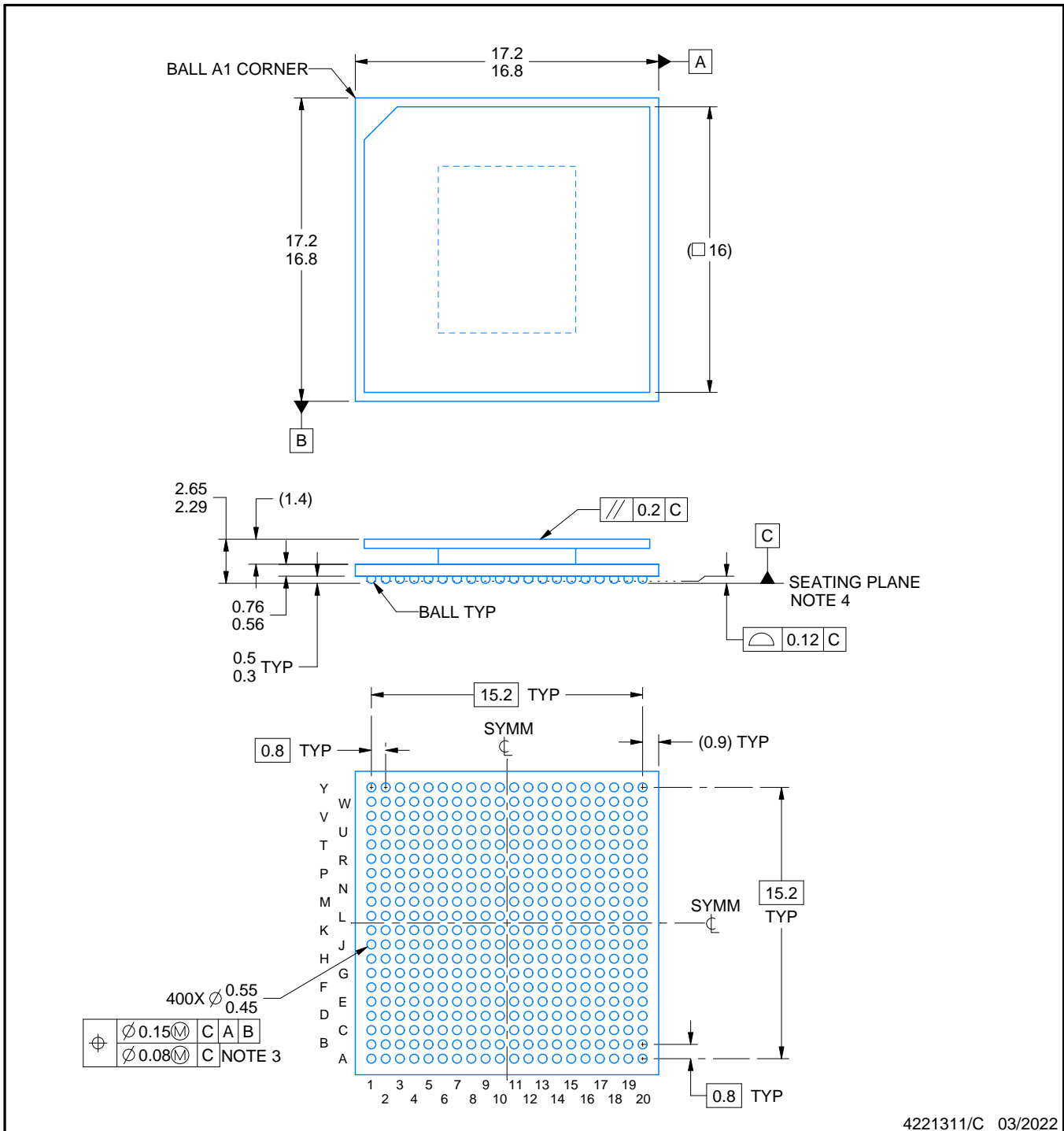

4221311/C 03/2022

NOTES:

1. All linear dimensions are in millimeters. Any dimensions in parenthesis are for reference only. Dimensioning and tolerancing per ASME Y14.5M.
2. This drawing is subject to change without notice.
3. Dimension is measured at the maximum solder ball diameter, parallel to primary datum C.
4. Primary datum C and seating plane are defined by the spherical crowns of the solder balls.

EXAMPLE BOARD LAYOUT

ABJ0400A

FCBGA - 2.65 mm max height

BALL GRID ARRAY

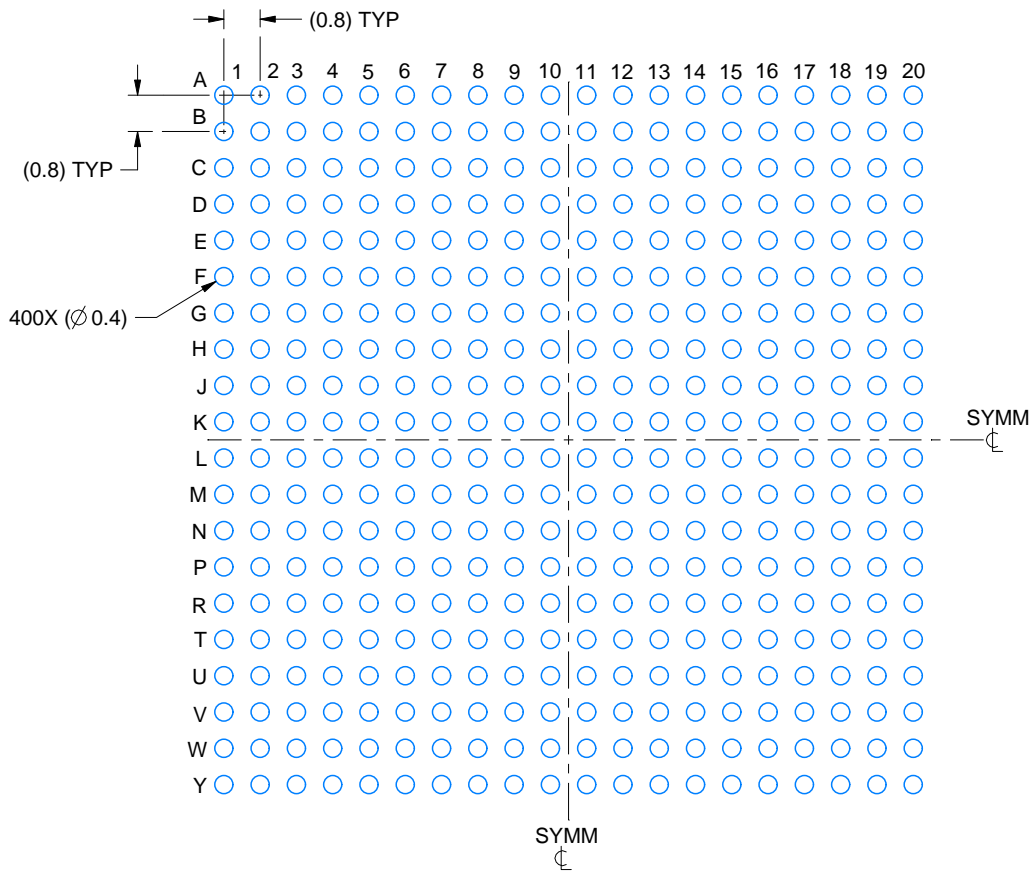

LAND PATTERN EXAMPLE
EXPOSED METAL SHOWN
SCALE:6X

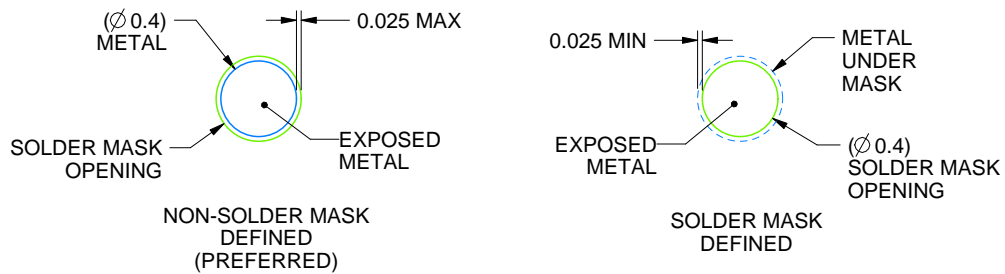

SOLDER MASK DETAILS
NOT TO SCALE

4221311/C 03/2022

NOTES: (continued)

- Final dimensions may vary due to manufacturing tolerance considerations and also routing constraints. For more information, see Texas Instruments literature number SPRU811 (www.ti.com/lit/spru811).

EXAMPLE STENCIL DESIGN

ABJ0400A

FCBGA - 2.65 mm max height

BALL GRID ARRAY

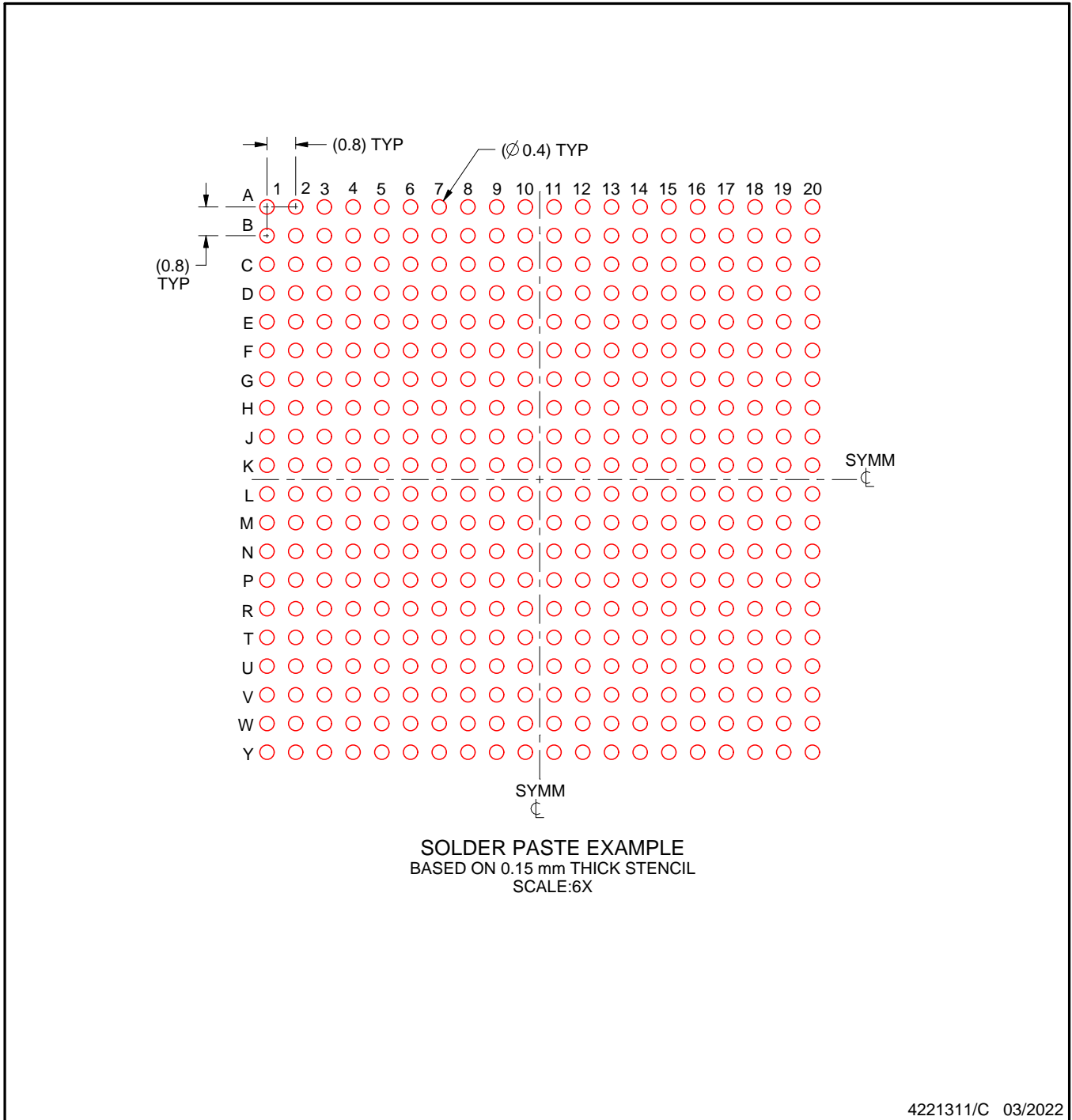

NOTES: (continued)

6. Laser cutting apertures with trapezoidal walls and rounded corners may offer better paste release.

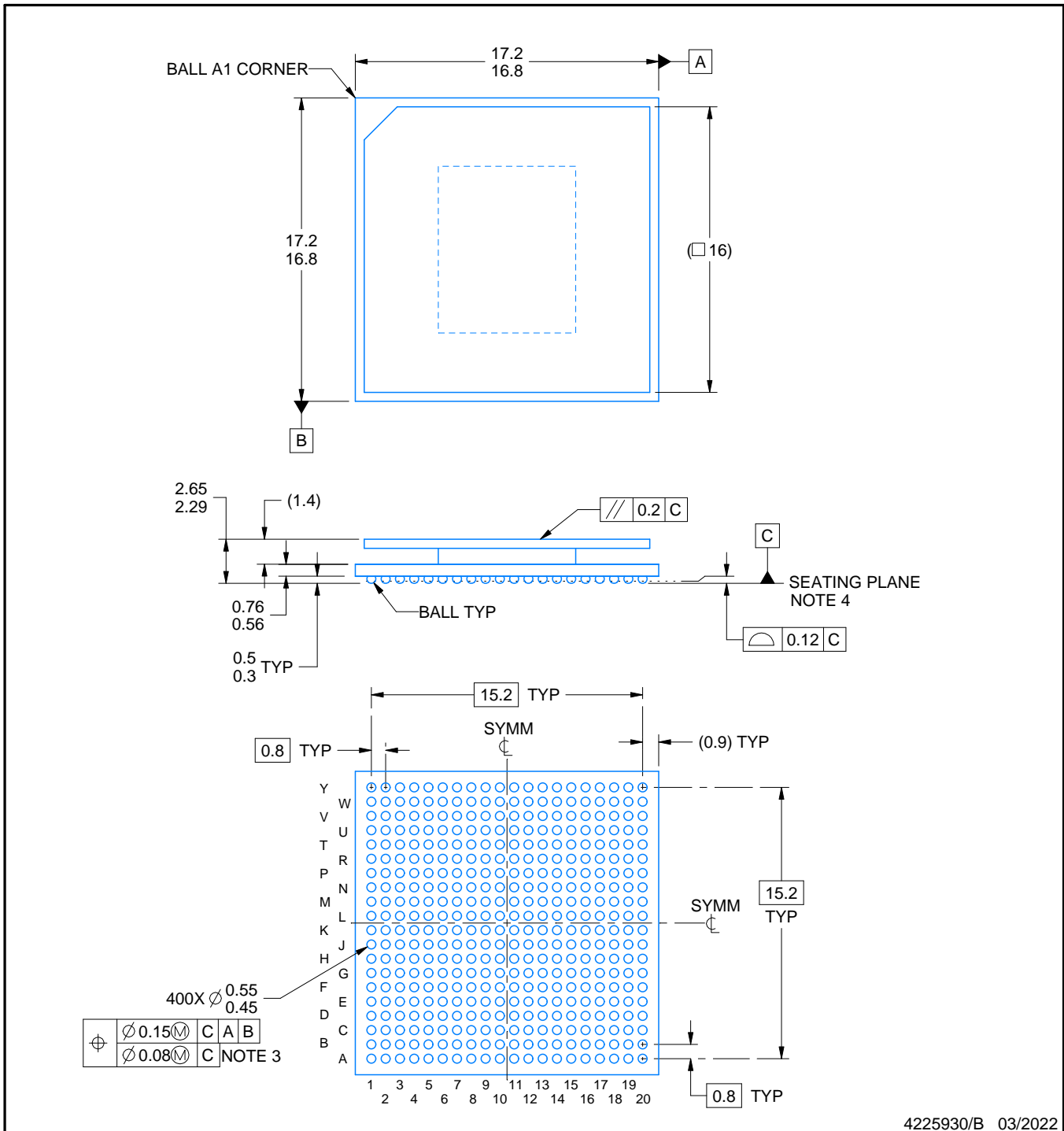
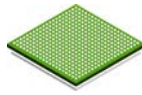

NOTES:

1. All linear dimensions are in millimeters. Any dimensions in parenthesis are for reference only. Dimensioning and tolerancing per ASME Y14.5M.
2. This drawing is subject to change without notice.
3. Dimension is measured at the maximum solder ball diameter, parallel to primary datum C.
4. Primary datum C and seating plane are defined by the spherical crowns of the solder balls.
5. Pb-Free die bump and SnPb solder ball.

EXAMPLE BOARD LAYOUT

ALK0400A

FCBGA - 2.65 mm max height

BALL GRID ARRAY

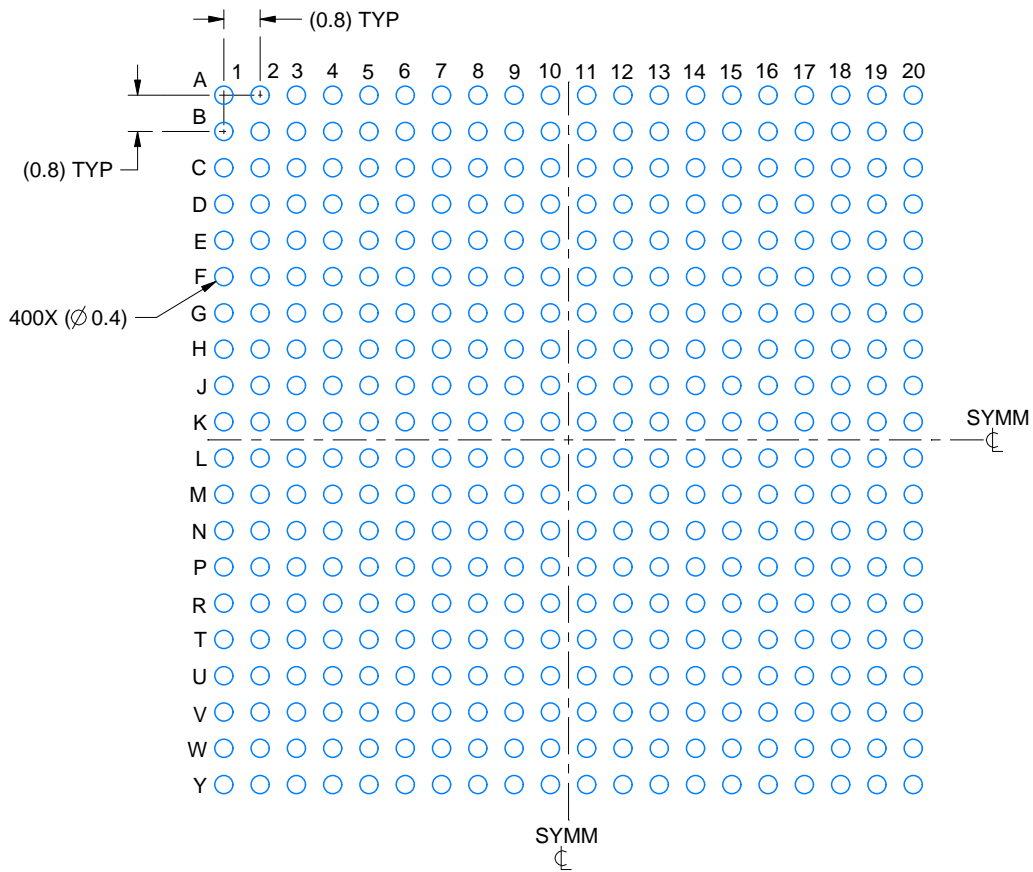

LAND PATTERN EXAMPLE
EXPOSED METAL SHOWN
SCALE:6X

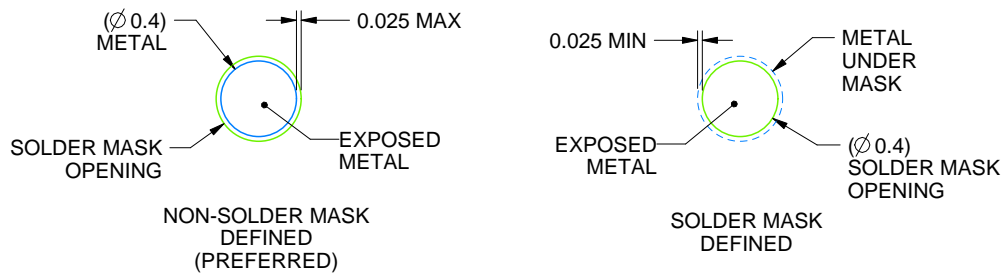

SOLDER MASK DETAILS
NOT TO SCALE

4225930/B 03/2022

NOTES: (continued)

- Final dimensions may vary due to manufacturing tolerance considerations and also routing constraints. For more information, see Texas Instruments literature number SPRU811 (www.ti.com/lit/spru811).

EXAMPLE STENCIL DESIGN

ALK0400A

FCBGA - 2.65 mm max height

BALL GRID ARRAY

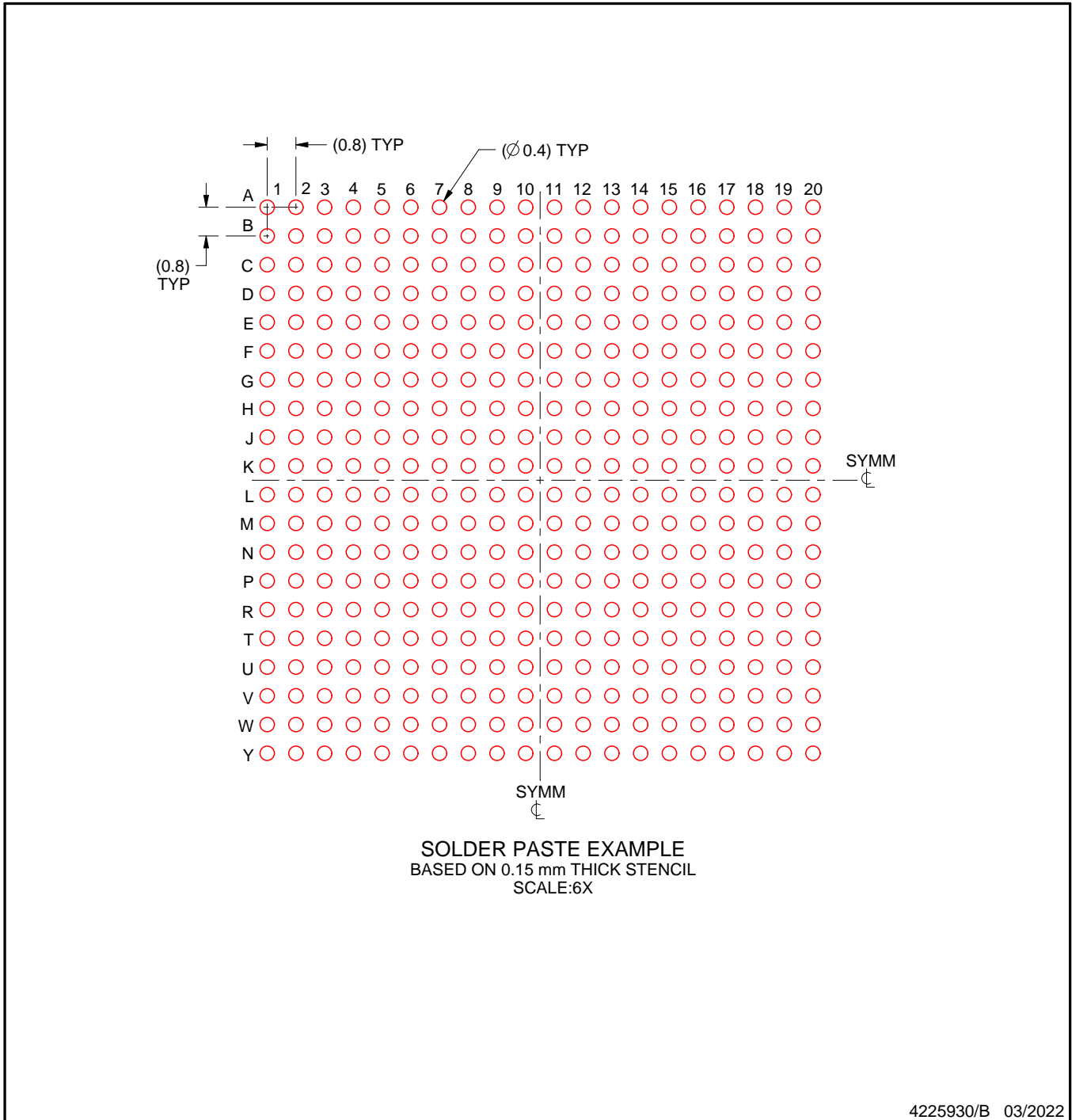

NOTES: (continued)

7. Laser cutting apertures with trapezoidal walls and rounded corners may offer better paste release.

重要声明和免责声明

TI“按原样”提供技术和可靠性数据（包括数据表）、设计资源（包括参考设计）、应用或其他设计建议、网络工具、安全信息和其他资源，不保证没有瑕疵且不做任何明示或暗示的担保，包括但不限于对适销性、某特定用途方面的适用性或不侵犯任何第三方知识产权的暗示担保。

这些资源可供使用 TI 产品进行设计的熟练开发人员使用。您将自行承担以下全部责任：(1) 针对您的应用选择合适的 TI 产品，(2) 设计、验证并测试您的应用，(3) 确保您的应用满足相应标准以及任何其他功能安全、信息安全、监管或其他要求。

这些资源如有变更，恕不另行通知。TI 授权您仅可将这些资源用于研发本资源所述的 TI 产品的应用。严禁对这些资源进行其他复制或展示。您无权使用任何其他 TI 知识产权或任何第三方知识产权。您应全额赔偿因在这些资源的使用中对 TI 及其代表造成的任何索赔、损害、成本、损失和债务，TI 对此概不负责。

TI 提供的产品受 [TI 的销售条款](#) 或 [ti.com](#) 上其他适用条款/TI 产品随附的其他适用条款的约束。TI 提供这些资源并不会扩展或以其他方式更改 TI 针对 TI 产品发布的适用的担保或担保免责声明。

TI 反对并拒绝您可能提出的任何其他或不同的条款。

邮寄地址：Texas Instruments, Post Office Box 655303, Dallas, Texas 75265

Copyright © 2022，德州仪器 (TI) 公司