



## 目录

1	特性 .....	1	8.4	Device Functional Modes .....	27
2	应用 .....	1	<b>9</b>	<b>Application and Implementation</b> .....	<b>28</b>
3	说明 .....	1	9.1	Application Information .....	28
4	修订历史记录 .....	2	9.2	Typical Application .....	28
5	<b>Device Options</b> .....	<b>4</b>	<b>10</b>	<b>Power Supply Recommendations</b> .....	<b>33</b>
6	<b>Pin Configuration and Functions</b> .....	<b>4</b>	<b>11</b>	<b>Layout</b> .....	<b>33</b>
7	<b>Specifications</b> .....	<b>6</b>	11.1	Layout Guidelines .....	33
7.1	Absolute Maximum Ratings .....	6	11.2	Layout Example .....	33
7.2	ESD Ratings .....	6	<b>12</b>	<b>器件和文档支持</b> .....	<b>34</b>
7.3	Recommended Operating Conditions .....	6	12.1	文档支持 .....	34
7.4	Thermal Information .....	6	12.2	相关链接 .....	34
7.5	Electrical Characteristics .....	7	12.3	接收文档更新通知 .....	34
7.6	Typical Characteristics .....	10	12.4	社区资源 .....	34
<b>8</b>	<b>Detailed Description</b> .....	<b>13</b>	12.5	商标 .....	34
8.1	Overview .....	13	12.6	静电放电警告 .....	34
8.2	Functional Block Diagram .....	14	12.7	Glossary .....	34
8.3	Feature Description .....	14	<b>13</b>	<b>机械、封装和可订购信息</b> .....	<b>34</b>

## 4 修订历史记录

注：之前版本的页码可能与当前版本有所不同。

Changes from Revision E (March 2015) to Revision F	Page
• 在整个文档中将所有 Qi v1.1 和 WPC v1.1 更改为 Qi v1.2 和 WPC v1.2 .....	1
• Added the <i>Adaptive Communication Limit</i> section .....	24
• Deleted $R_1 = 29.402\text{ k}\Omega$ $R_3 = 14.302\text{ k}\Omega$ and added a link to SLUS629 in the <i>Internal Temperature Sense (TS Function of the TS/CTRL Pin)</i> section .....	25

Changes from Revision D (January 2014) to Revision E	Page
• 已添加 <i>ESD</i> 额定值表，特性说明部分、器件功能模式、应用和实施部分、电源建议部分、布局部分、器件和文档支持部分，以及机械、封装和可订购信息部分 .....	1
• 已添加 bq51052B 4.40V 选项 .....	1
• Updated pinout images .....	4
• Added thermal pad description in <i>Pin Functions</i> table .....	4
• Added AD voltage to <i>Recommended Operating Conditions</i> .....	6
• Changed RECT overvoltage specification name from $V_{RECT}$ to $V_{OVP}$ .....	7
• Changed to $I_{LIM\_SHORT\_OK}$ from $I_{LIM\_SC}$ for clarity .....	7
• Added $V_{OREG}$ for bq51052B .....	8
• Added minimum current for $K_{ILIM}$ .....	8
• Changed $K_{ILIM}$ TYP value from 300 to 314 (min / max also changed) .....	8
• Added $I_{BULK}$ spec for charging minimum and maximum .....	8
• Added $V_{RECH}$ for bq51052B .....	8
• Added new spec $I_{Termination}$ .....	8
• Changed to VTSB from VTS for clarity .....	8
• Changed from $I_{TS-Bias}$ for clarity .....	8
• Deleted $V_{OC-F}$ as redundant .....	8
• Changed typical JEITA regulation on bq51050B from 4.10 V to 4.06 V .....	8
• Changed to clarify CTRL pin high and low levels .....	8

• Changed Thermal shutdown name to $T_{J-SD}$ for clarity .....	9
• Added section to describe Adapter Enable function.....	9
• Changed Synchronous rectifier switchover name to $I_{BAT-SR}$ for clarity.....	9
• Added synchronous mode entry for bq51052B .....	9
• Deleted note regarding internal junction monitor reducing current - it is not applicable. ....	19
• Added section on modified JEITA profile for bq51052B.....	21
• Changed TS/CTRL function to correct Termination Packet value.....	22
• Added Taper mode completion for Termination Packet .....	22
• Changed Beta value from 4500 to 3380 to match NTC datasheet .....	25
• Changed received power maximum error from 250 mW to 375 mW to comply with latest WPC v1.2 specification .....	27

**Changes from Revision C (February 2013) to Revision D**
**Page**

• Changed the ABSOLUTE MAXIMUM RATINGS - moved AC1 and AC2 onto a single row with a Min value of $-0.8$ .....	6
• Added section: Details of a Qi Wireless Power System and bq5105xB Power Transfer Flow Diagrams.....	15
• Changed text in the Battery Charge Profile section .....	19
• Changed Battery failure Conditions in <a href="#">Table 1</a> .....	22
• Changed <a href="#">Equation 3</a> and <a href="#">Equation 4</a> .....	25
• Changed $R_2 = 7.81 \text{ k}\Omega$ To: $R_1 = 29.402 \text{ k}\Omega$ .....	25
• Changed $R_3 = 13.98 \text{ k}\Omega$ To: $R_3 = 14.302 \text{ k}\Omega$ in the <i>Internal Temperature Sense (TS Function of the TS/CTRL Pin)</i> section .....	25
• Changed $T_{HOT} = 0^\circ\text{C}$ To: $T_{HOT} = 60^\circ\text{C}$ .....	25
• Changed <a href="#">Equation 6</a> .....	29

**Changes from Revision B (September 2012) to Revision C**
**Page**

• 完整数据表第一版 .....	1
------------------	---

**Changes from Revision A (August 2012) to Revision B**
**Page**

• 将最后一条 特性 要点由“1.9 x 3.0mm WCSP 和 4.5 x 3.5mm QFN 封装选项”更改为“采用小型 WCSP 和 QFN 封装”.....	1
• 更改了图表 1 并将标题从：无线充电联盟（WPC 或 Qi）感应充电系统，改为：典型系统方框图显示 bq5105xB 被用作一个无线电源锂离子/锂聚合物电池充电器 .....	1
• 补充说明：如需了解产品详细信息和设计资源，请访问 <a href="http://ti.com/wirelesspower">ti.com/wirelesspower</a> .....	1

**Changes from Original (August 2012) to Revision A**
**Page**

• Changed Regulated BAT(output) voltage.....	8
• Changed Recharge threshold for bq51052B.....	8
• Deleted $I_{TS-Bias-Max}$ .....	8
• Changed $V_{COLD}$ to $V_{OC}$ and values .....	8
• Changed $V_{45C}$ values.....	8
• Changed $V_{60C}$ values.....	8
• Changed <a href="#">Figure 25</a> .....	21
• Changed <a href="#">Figure 25</a> .....	22

## 5 Device Options

DEVICE	FUNCTION	V <sub>RECT-OVP</sub>	V <sub>RECT-REG</sub>	V <sub>BAT-REG</sub>	NTC MONITORING
bq51050B	4.20-V Li-Ion Wireless Battery Charger	15 V	Track	4.20 V	JEITA
bq51051B	4.35-V Li-Ion Wireless Battery Charger	15 V	Track	4.35 V	JEITA
bq51052B	4.40-V Li-Ion Wireless Battery Charger	15 V	Track	4.40 V	Modified JEITA

## 6 Pin Configuration and Functions

**YFP Package  
28-Pin DSBGA  
Top View**

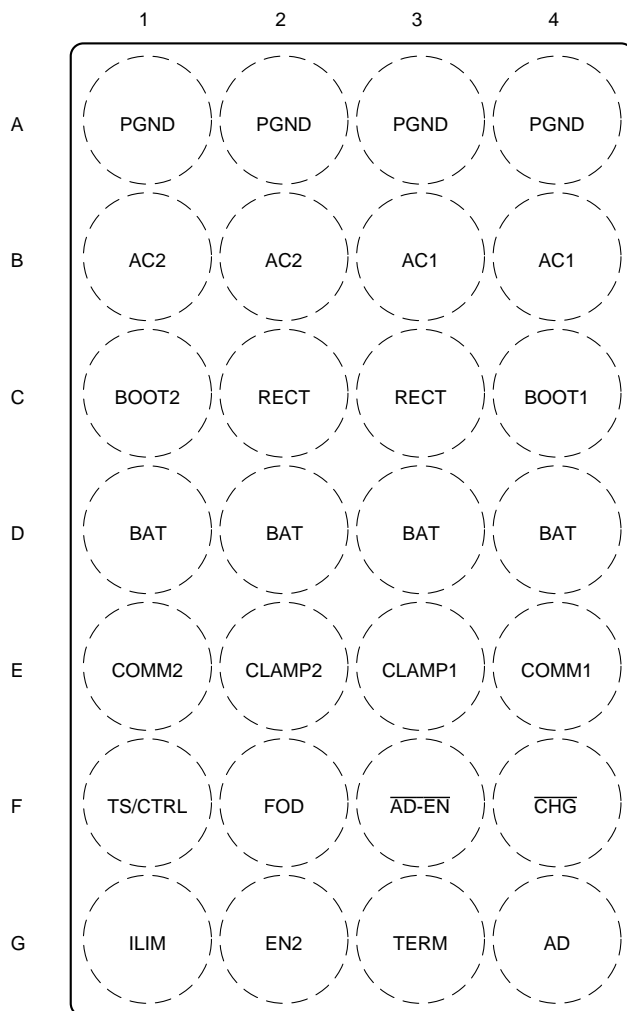

**RHL Package  
20-Pin VQFN With Exposed Thermal Pad  
Top View**

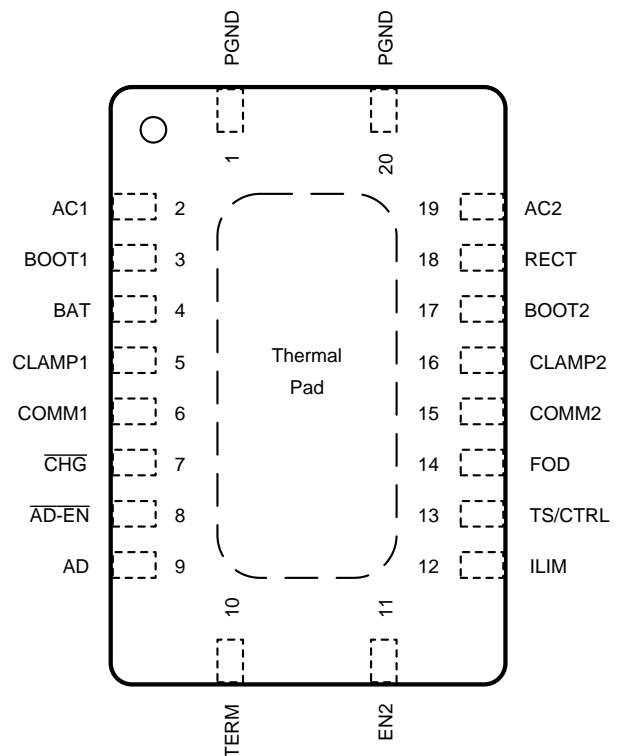

The exposed thermal pad should be connected to ground.

### Pin Functions

Pin			I/O	DESCRIPTION
NAME	DSBGA	VQFN		
AC1	B3, B4	2	I	Input power from receiver coil.
AC2	B1, B2	19	I	Input power from receiver coil.
AD	G4	9	I	If AD functionality is used, connect this pin to the wired adapter input. When $V_{AD-PreS}$ is applied to this pin wireless charging is disabled and AD_ENn is driven low. Connect a 1- $\mu$ F capacitor from AD to PGND. If unused, the capacitor is not required and AD should be connected directly to PGND.
$\overline{AD-EN}$	F3	8	O	Push-pull driver for external PFET when wired charging is active. Float if not used.
BAT	D1	4	O	Output pin, delivers power to the battery while applying the internal charger profile.
	D2			
	D3			
	D4			
BOOT1	C4	3	O	Bootstrap capacitors for driving the high-side FETs of the synchronous rectifier. Connect a 10-nF ceramic capacitor from BOOT1 to AC1 and from BOOT2 to AC2.
BOOT2	C1	17	O	
$\overline{CHG}$	F4	7	O	Open-drain output – active when BAT is enabled. Float if not used.
CLAMP1	E3	5	O	Open-drain FETs which are used for a non-power dissipative overvoltage AC clamp protection. When the RECT voltage goes above 15 V, both switches will be turned on and the capacitors will act as a low impedance to protect the device from damage. If used, capacitors are used to connect CLAMP1 to AC1 and CLAMP2 to AC2. Recommended connections are 0.47- $\mu$ F capacitors.
CLAMP2	E2	16	O	
COMM1	E4	6	O	Open-drain outputs used to communicate with primary by varying reflected impedance. Connect a capacitor from COMM1 to AC1 and a capacitor from COMM2 to AC2 for capacitive load modulation. For resistive modulation connect COMM1 and COMM2 to RECT through a single resistor. See <a href="#">Communication Modulator</a> for more information.
COMM2	E1	15	O	
EN2	G2	11	I	Used to set priority between wireless power and wired power. EN2 low enables wired charging source if AD input voltage is present. EN2 high disables wired charging source and wireless power is enabled if present.
FOD	F2	14	I	Input for the rectified power measurement. See <a href="#">WPC v1.2 Compatibility</a> for details.
ILIM	G1	12	I/O	Programming pin for the battery charge current. The total resistance from ILIM to PGND ( $R_{ILIM}$ ) sets the charge current. <a href="#">Figure 32</a> shows $R_{ILIM}$ to be $R_1 + R_{FOD}$ . Details can be found in <a href="#">Electrical Characteristics</a> and <a href="#">Battery Charge Current Setting Calculations</a> .
PGND	A1	1, 20	–	Power ground
	A2			
	A3			
	A4			
RECT	C2, C3	18	O	Filter capacitor for the internal synchronous rectifier. Connect a ceramic capacitor to PGND. Depending on the power levels, the value may be from 4.7 $\mu$ F to 22 $\mu$ F.
TERM	G3	10	I	Input that is used to set the termination threshold. Termination current is the battery current level below which the charge process will cease. The termination current is set as a percentage of the charge current. See <a href="#">Battery Charge Current Setting Calculations</a> for more details.
TS/CTRL	F1	13	I	Temperature Sense (TS) and Control (CTRL) pin functionality. For the TS functionality connect TS/CTRL to ground through a Negative Temperature Coefficient (NTC) resistor. If an NTC function is not desired, connect to PGND with a 10-k $\Omega$ resistor. As a CTRL pin pull low to send end power transfer (EPT) fault to the transmitter or pull up to an internal rail to send EPT termination to the transmitter. See <a href="#">Internal Temperature Sense (TS Function of the TS/CTRL Pin)</a> for more details.
—	—	PAD	—	The exposed thermal pad should be connected to ground (PGND).

## 7 Specifications

### 7.1 Absolute Maximum Ratings<sup>(1)(2)</sup>

over operating free-air temperature range (unless otherwise noted)

		MIN	MAX	UNIT
Input voltage	RECT, COMM1, COMM2, BAT, $\overline{\text{CHG}}$ , CLAMP1, CLAMP2	-0.3	20	V
	AC1, AC2	-0.8	20	V
	AD, AD-EN	-0.3	30	V
	BOOT1, BOOT2	-0.3	26	V
	EN2, TERM, FOD, TS/CTRL, ILIM	-0.3	7	V
Input current	AC1, AC2		2	A(RMS)
Output current	BAT		1.5	A
Output sink current	$\overline{\text{CHG}}$		15	mA
	COMM1, COMM2		1.0	A
Junction temperature, $T_J$		-40	150	°C
Storage temperature, $T_{\text{stg}}$		-65	150	°C

- (1) Stresses beyond those listed under *Absolute Maximum Ratings* may cause permanent damage to the device. These are stress ratings only, and functional operation of the device at these or any other conditions beyond those indicated under *Recommended Operating Conditions* is not implied. Exposure to absolute-maximum-rated conditions for extended periods may affect device reliability.
- (2) All voltages are with respect to the VSS terminal, unless otherwise noted.

### 7.2 ESD Ratings

		VALUE	UNIT
$V_{\text{ESD}}$ Electrostatic discharge	Human-body model (HBM), per ANSI/ESDA/JEDEC JS-001 <sup>(1)</sup>	±2000	V
	Charged-device model (CDM), per JEDEC specification JESD22-C101 <sup>(2)</sup>	±500	

- (1) JEDEC document JEP155 states that 500-V HBM allows safe manufacturing with a standard ESD control process.
- (2) JEDEC document JEP157 states that 250-V CDM allows safe manufacturing with a standard ESD control process.

### 7.3 Recommended Operating Conditions

over operating free-air temperature range (unless otherwise noted)

			MIN	MAX	UNIT	
$V_{\text{IN}}$	Input voltage range	RECT	4	10	V	
$I_{\text{IN}}$	Input current	Internal Rectifier (voltage monitored at RECT node)			1.5	A
$I_{\text{BAT}}$	BAT(output) current	BAT	bq51050B, bq51051B		1.5	A
			bq51052B		0.8	
$V_{\text{AD}}$	Adapter voltage	AD		15	V	
$I_{\text{AD-EN}}$	Sink current	$\overline{\text{AD-EN}}$		1	mA	
$I_{\text{COMM}}$	COMM sink current	COMM		500	mA	
$T_J$	Junction temperature		0	125	°C	

### 7.4 Thermal Information

THERMAL METRIC <sup>(1)</sup>		bq51050B, bq51051B, bq51052B		UNIT
		YFP (DSGBA)	RHL (VQFN)	
		28 PINS	20 PINS	
$R_{\theta\text{JA}}$	Junction-to-ambient thermal resistance	58.9	37.7	°C/W
$R_{\theta\text{JC(top)}}$	Junction-to-case (top) thermal resistance	0.2	35.5	°C/W
$R_{\theta\text{JB}}$	Junction-to-board thermal resistance	9.1	13.6	°C/W
$\psi_{\text{JT}}$	Junction-to-top characterization parameter	1.4	0.5	°C/W
$\psi_{\text{JB}}$	Junction-to-board characterization parameter	8.9	13.5	°C/W

- (1) For more information about traditional and new thermal metrics, see the [Semiconductor and IC Package Thermal Metrics](#) application report.

**Thermal Information (continued)**

THERMAL METRIC <sup>(1)</sup>		bq51050B, bq51051B, bq51052B		UNIT
		YFP (DSGBA)	RHL (VQFN)	
		28 PINS	20 PINS	
R <sub>θJC(bot)</sub>	Junction-to-case (bottom) thermal resistance	n/a	2.7	°C/W

**7.5 Electrical Characteristics**

Over junction temperature range 0°C ≤ T<sub>J</sub> ≤ 125°C and recommended supply voltage (unless otherwise noted)

PARAMETER		TEST CONDITIONS		MIN	TYP	MAX	UNIT	
V <sub>UVLO</sub>	Undervoltage lockout	V <sub>RECT</sub> : 0 V → 3 V		2.6	2.7	2.8	V	
V <sub>HYS-UVLO</sub>	Hysteresis on UVLO	V <sub>RECT</sub> : 3 V → 2 V			250		mV	
V <sub>OVP</sub>	Input overvoltage threshold	V <sub>RECT</sub> : 5 V → 16 V		14.5	15	15.5	V	
V <sub>HYS-OVP</sub>	Hysteresis on OVP	V <sub>RECT</sub> : 16 V → 5 V			150		mV	
V <sub>RECT-REG</sub> <sup>(1)</sup>	V <sub>RECT</sub> regulation voltage				5.11		V	
I <sub>LOAD</sub>	I <sub>LOAD</sub> Hysteresis for dynamic V <sub>RECT</sub> thresholds as a % of I <sub>ILIM</sub>	I <sub>LOAD</sub> falling			5%			
V <sub>TRACK</sub>	Tracking V <sub>RECT</sub> regulation above V <sub>BAT</sub>	V <sub>BAT</sub> = 3.5 V, I <sub>BAT</sub> ≥ 500 mA			300		mV	
V <sub>RECT-REV</sub>	Rectifier reverse voltage protection at the BAT(output)	V <sub>RECT-REV</sub> = V <sub>BAT</sub> - V <sub>RECT</sub> , V <sub>BAT</sub> = 10 V			8.3	9	V	
V <sub>RECT-DPM</sub>	Rectifier undervoltage protection, restricts I <sub>BAT</sub> at V <sub>RECT-DPM</sub>			3	3.1	3.2	V	
<b>QUIESCENT CURRENT</b>								
I <sub>RECT</sub>	Active chip quiescent current consumption from RECT (when wireless power is present)	I <sub>BAT</sub> = 0 mA, 0°C ≤ T <sub>J</sub> ≤ 85°C			8	10	mA	
		I <sub>BAT</sub> = 300 mA, 0°C ≤ T <sub>J</sub> ≤ 85°C			2	3	mA	
I <sub>Q</sub>	Quiescent current at the BAT when wireless power is disabled (Standby)	V <sub>BAT</sub> = 4.2 V, 0°C ≤ T <sub>J</sub> ≤ 85°C			12	20	μA	
<b>ILIM SHORT PROTECTION</b>								
R <sub>ILIM-SHORT</sub>	Highest value of ILIM resistor considered a fault (short). Monitored for I <sub>BAT</sub> > I <sub>LIM_SHORT, OK</sub>	R <sub>ILIM</sub> : 200 Ω → 50 Ω. I <sub>BAT</sub> latches off, cycle power to reset	bq51050B, bq51051B			120	Ω	
			bq51052B			235		
t <sub>DGL-Short</sub>	Deglintch time transition from ILIM short to I <sub>BAT</sub> disable				1		ms	
I <sub>LIM_SHORT, OK</sub>	I <sub>LIM_SHORT, OK</sub> enables the I <sub>ILIM</sub> short comparator when I <sub>BAT</sub> is greater than this value	I <sub>BAT</sub> : 0 mA → 200 mA		bq51050B, bq51051B	110	145	165	mA
				bq51052B	55	75	95	
I <sub>LIM-SHORT, OK</sub> HYSTERESIS	Hysteresis for I <sub>LIM_SHORT, OK</sub> comparator	I <sub>BAT</sub> : 200 mA → 0 mA			30		mA	
I <sub>BAT-CL</sub>	Maximum output current limit	Maximum I <sub>BAT</sub> that will be delivered for up to 1 ms when ILIM is shorted to PGND				2.4	A	
<b>BATTERY SHORT PROTECTION</b>								
V <sub>BAT(SC)</sub>	BAT pin short-circuit detection/precharge threshold	V <sub>BAT</sub> : 3 V → 0.5 V, no deglitch		0.75	0.8	0.85	V	
V <sub>BAT(SC)-HYS</sub>	V <sub>BAT(SC)</sub> hysteresis	V <sub>BAT</sub> : 0.5 V → 3 V			100		mV	
I <sub>BAT(SC)</sub>	Source current to BAT pin during short-circuit detection	V <sub>BAT</sub> = 0 V	bq51050B, bq51051B	12	18	22	mA	
			bq51052B	12	18	25		
<b>VOLTAGE REGULATION PHASE</b>								
I <sub>EndTrack</sub>	I <sub>BAT</sub> threshold during Voltage Regulation Phase that changes V <sub>RECT</sub> level from V <sub>BAT</sub> +V <sub>TRACK</sub> to V <sub>RECT-REG</sub>	I <sub>BAT</sub> decreasing	bq51050B, bq51051B		0.35 * I <sub>BULK</sub>		mA	
			bq51052B		0.05 * I <sub>BULK</sub>			

(1) V<sub>RECT-REG</sub> is overridden when rectifier foldback mode is active (V<sub>RECT-REG</sub>-V<sub>TRACK</sub>).

## Electrical Characteristics (continued)

 Over junction temperature range  $0^{\circ}\text{C} \leq T_J \leq 125^{\circ}\text{C}$  and recommended supply voltage (unless otherwise noted)

PARAMETER		TEST CONDITIONS	MIN	TYP	MAX	UNIT	
<b>PRECHARGE</b>							
$V_{\text{LOWV}}$	Precharge to fast charge transition threshold	$V_{\text{BAT}}: 2\text{ V} \rightarrow 4\text{ V}$	2.9	3.0	3.1	V	
$K_{\text{PRECHG}}$	Precharge current as a percentage of the programmed charge current setting ( $I_{\text{BULK}}$ )	$V_{\text{LOWV}} > V_{\text{BAT}} > V_{\text{BAT(SC)}}$ $I_{\text{BAT}}: 50\text{ mA} - 300\text{ mA}$	18%	20%	23%		
$I_{\text{PRECHG}}$	$I_{\text{BAT}}$ during precharge	$V_{\text{LOWV}} > V_{\text{BAT}} > V_{\text{BAT(SC)}}$ , $I_{\text{BULK}} = 500\text{ mA}$		100		mA	
$t_{\text{precharge}}$	Precharge time-out	$V_{\text{BAT(SC)}} < V_{\text{BAT}} < V_{\text{LOWV}}$		30		min	
$t_{\text{DGL1(LOWV)}}$	Deglitch time, pre- to fast-charge			25		ms	
$t_{\text{DGL2(LOWV)}}$	Deglitch time, fast- to precharge			25		ms	
<b>OUTPUT</b>							
$V_{\text{OREG}}$	Regulated BAT(output) voltage	$I_{\text{BAT}} = 1000\text{ mA}$	bq51050B	4.16	4.20	4.22	V
			bq51051B	4.30	4.35	4.37	
			bq51052B	4.36	4.40	4.44	
$V_{\text{DO}}$	Drop-out voltage, RECT to BAT	$I_{\text{BAT}} = 1\text{ A}$		110	190	mV	
$K_{\text{LIM}}$	Current programming factor	$R_{\text{LIM}} = K_{\text{LIM}} / I_{\text{BULK}}$ (500 mA - 1.5 A)	bq51050B, bq51051B	303	314	321	A $\Omega$
		$R_{\text{LIM}} = K_{\text{LIM}} / I_{\text{BULK}}$ (500 mA - 1.0 A)	bq51052B				
$I_{\text{BULK}}$	Battery charging current limits	$K_{\text{LIM}}$ 303 to 321	bq51050B, bq51051B	500	1,500	mA	
			bq51052B	500	1,000		
$t_{\text{fast-charge}}$	Fast-charge timer	$V_{\text{LOWV}} < V_{\text{BAT}} < V_{\text{BAT-REG}}$		10		hours	
$I_{\text{BAT-R}}$	Battery charge current limit programming range				1500	mA	
$I_{\text{COMM-CL}}$	Current limit during communication		330	390	420	mA	
<b>TERMINATION</b>							
$K_{\text{TERM}}$	Programmable termination current as a percentage of $I_{\text{BULK}}$	$R_{\text{TERM}} = \%I_{\text{BULK}} \times K_{\text{TERM}}$ ( $I_{\text{BULK}} = 500\text{ mA}$ )	200	240	280	$\Omega/\%$	
$I_{\text{TERM-Th}}$	Termination current from BAT, defined with $K_{\text{TERM}}$ , as the current that terminates the charge cycle	$I_{\text{BAT}}$ decreasing, $R_{\text{TERM}} = 2.4\text{ k}\Omega$ , $I_{\text{BULK}} = 1000\text{ mA}$		100		mA	
$I_{\text{TERM}}$	Constant current at the TERM pin to bias the termination reference		40	50	55	$\mu\text{A}$	
$V_{\text{RECH}}$	Recharge threshold		bq51050B	$V_{\text{BAT-REG}} - 135\text{ mV}$	$V_{\text{BAT-REG}} - 110\text{ mV}$	$V_{\text{BAT-REG}} - 90\text{ mV}$	V
			bq51051B	$V_{\text{BAT-REG}} - 125\text{ mV}$	$V_{\text{BAT-REG}} - 95\text{ mV}$	$V_{\text{BAT-REG}} - 70\text{ mV}$	
			bq51052B	$V_{\text{BAT-REG}} - 125\text{ mV}$	$V_{\text{BAT-REG}} - 95\text{ mV}$	$V_{\text{BAT-REG}} - 70\text{ mV}$	
$I_{\text{Termination}}$	Termination current setting limits		120			mA	
<b>TS / CTRL FUNCTIONALITY</b>							
$V_{\text{TSB}}$	Internal TS bias voltage ( $V_{\text{TS}}$ is the voltage at the TS/CTRL pin, $V_{\text{TSB}}$ is the internal bias voltage)	$I_{\text{TSB}} < 100\text{ }\mu\text{A}$ (periodically driven see $t_{\text{TS/CTRL-Meas}}$ )	2	2.2	2.4	V	
$V_{\text{0C-R}}$	Rising threshold	$V_{\text{TS}}: 50\% \rightarrow 60\%$	57	58.7	60	$\%V_{\text{TSB}}$	
$V_{\text{0C-Hyst}}$	Hysteresis on $0^{\circ}\text{C}$ Comparator	$V_{\text{TS}}: 60\% \rightarrow 50\%$		2.4		$\%V_{\text{TSB}}$	
$V_{\text{10C}}$	Rising threshold	$V_{\text{TS}}: 40\% \rightarrow 50\%$	46	47.8	49	$\%V_{\text{TSB}}$	
$V_{\text{10C-Hyst}}$	Hysteresis on $10^{\circ}\text{C}$ Comparator	$V_{\text{TS}}: 50\% \rightarrow 40\%$		2		$\%V_{\text{TSB}}$	
$V_{\text{45C}}$	Falling threshold	$V_{\text{TS}}: 25\% \rightarrow 15\%$	18	19.6	21	$\%V_{\text{TSB}}$	
$V_{\text{45C-Hyst}}$	Hysteresis on $45^{\circ}\text{C}$ Comparator	$V_{\text{TS}}: 15\% \rightarrow 25\%$		3		$\%V_{\text{TSB}}$	
$V_{\text{60C}}$	Falling threshold	$V_{\text{TS}}: 20\% \rightarrow 5\%$	12	13.1	14	$\%V_{\text{TSB}}$	
$V_{\text{60C-Hyst}}$	Hysteresis on $60^{\circ}\text{C}$ Comparator	$V_{\text{TS}}: 5\% \rightarrow 20\%$		1		$\%V_{\text{TSB}}$	
$I_{\text{45C}}$	$I_{\text{BULK}}$ reduction percentage at $45^{\circ}\text{C}$ (in full JEITA mode - N/A for bq51052B)	$V_{\text{TS}}: 25\% \rightarrow 15\%$ , $I_{\text{BAT}} = I_{\text{BULK}}$	45%	50%	55%		
$V_{\text{O-J}}$	Voltage regulation during JEITA temperature range		bq51050B	4.06		V	
			bq51051B	4.2			
			bq51052B	4.2			
$V_{\text{CTRL-HI}}$	Voltage on CTRL pin for a high		0.2		5	V	



## Electrical Characteristics (continued)

Over junction temperature range  $0^{\circ}\text{C} \leq T_J \leq 125^{\circ}\text{C}$  and recommended supply voltage (unless otherwise noted)

PARAMETER		TEST CONDITIONS	MIN	TYP	MAX	UNIT	
$V_{\text{CTRL-LOW}}$	Voltage on CTRL pin for a low		0		0.1	V	
$t_{\text{TS/CTRL-Meas}}$	Time period of TS/CTRL measurements (when $V_{\text{TSB}}$ is being driven internally)	TS bias voltage is only driven when communication packets are sent		24		ms	
$t_{\text{TS-Deglitch}}$	Deglitch time for all TS comparators			10		ms	
NTC-Pullup	Pullup resistor for the NTC network. Pulled up to the TS bias LDO.		18	20	22	k $\Omega$	
NTC- $R_{\text{NOM}}$	Nominal resistance requirement at 25°C of the NTC resistor			10		k $\Omega$	
NTC-Beta	Beta requirement for accurate temperature sensing through the above specified thresholds			3380		$\Omega$	
<b>THERMAL PROTECTION</b>							
$T_{\text{J-SD}}$	Thermal shutdown temperature			155		$^{\circ}\text{C}$	
$T_{\text{J-Hys}}$	Thermal shutdown hysteresis			20		$^{\circ}\text{C}$	
<b>OUTPUT LOGIC LEVELS ON <math>\overline{\text{CHG}}</math></b>							
$V_{\text{OL}}$	Open-drain $\overline{\text{CHG}}$ pin	$I_{\text{SINK}} = 5 \text{ mA}$			500	mV	
$I_{\text{OFF,CHG}}$	$\overline{\text{CHG}}$ leakage current when disabled	$V_{\text{CHG}} = 20 \text{ V}$ , $0^{\circ}\text{C} \leq T_J \leq 85^{\circ}\text{C}$			1	$\mu\text{A}$	
<b>COMM PIN</b>							
$R_{\text{DS-ON(COMM)}}$	COMM1 and COMM2	$V_{\text{RECT}} = 2.6 \text{ V}$		1		$\Omega$	
$f_{\text{COMM}}$	Signaling frequency on COMM pin			2		kb/s	
$I_{\text{OFF,COMM}}$	COMM pin leakage current	$V_{\text{COMM1}} = 20 \text{ V}$ , $V_{\text{COMM2}} = 20 \text{ V}$			1	$\mu\text{A}$	
<b>CLAMP PIN</b>							
$R_{\text{DS-ON(CLAMP)}}$	CLAMP1 and CLAMP2			0.75		$\Omega$	
<b>ADAPTER ENABLE</b>							
$V_{\text{AD-Pres}}$	$V_{\text{AD}}$ Rising threshold voltage. EN-UVLO	$V_{\text{AD}} 0 \text{ V} \rightarrow 5 \text{ V}$	3.5	3.6	3.8	V	
$V_{\text{AD-PresH}}$	$V_{\text{AD-Pres}}$ hysteresis, EN-HYS	$V_{\text{AD}} 5 \text{ V} \rightarrow 0 \text{ V}$		400		mV	
$I_{\text{AD}}$	Input leakage current	$V_{\text{RECT}} = 0 \text{ V}$ , $V_{\text{AD}} = 5 \text{ V}$			60	$\mu\text{A}$	
$R_{\text{AD}}$	Pullup resistance from $\overline{\text{AD-EN}}$ to BAT when adapter mode is disabled and $V_{\text{BAT}} > V_{\text{AD}}$ , EN-OUT	$V_{\text{AD}} = 0 \text{ V}$ , $V_{\text{BAT}} = 5 \text{ V}$		200	350	$\Omega$	
$V_{\text{AD-Diff}}$	Voltage difference between $V_{\text{AD}}$ and $V_{\text{AD-EN}}$ when adapter mode is enabled, EN-ON	$V_{\text{AD}} = 5 \text{ V}$ , $0^{\circ}\text{C} \leq T_J \leq 85^{\circ}\text{C}$	3	4.5	5	V	
<b>SYNCHRONOUS RECTIFIER</b>							
$I_{\text{BAT-SR}}$	$I_{\text{BAT}}$ at which the synchronous rectifier enters half synchronous mode, SYNC_EN	$I_{\text{BAT}} 200 \text{ mA} \rightarrow 0 \text{ mA}$	bq51050B, bq51051B	80	115	140	mA
			bq51052B	20	50	65	
$I_{\text{BAT-SRH}}$	Hysteresis for $I_{\text{BAT-SR}}$ (full-synchronous mode enabled)	$I_{\text{BAT}} 0 \text{ mA} \rightarrow 200 \text{ mA}$	bq51050B, bq51051B		25		
			bq51052B		28		
$V_{\text{HS-DIODE}}$	High-side diode drop when the rectifier is in half synchronous mode	$I_{\text{AC-VRECT}} = 250 \text{ mA}$ , and $T_J = 25^{\circ}\text{C}$		0.7		V	
<b>EN2</b>							
$V_{\text{IL}}$	Input low threshold for EN2				0.4	V	
$V_{\text{IH}}$	Input high threshold for EN2		1.3			V	
$R_{\text{PD, EN}}$	EN2 pulldown resistance			200		k $\Omega$	
<b>ADC</b>							
$P_{\text{PowerREC}}$	Received power measurement	0 W – 5 W received power after calibration of Rx magnetics losses		0.25		W	

## 7.6 Typical Characteristics

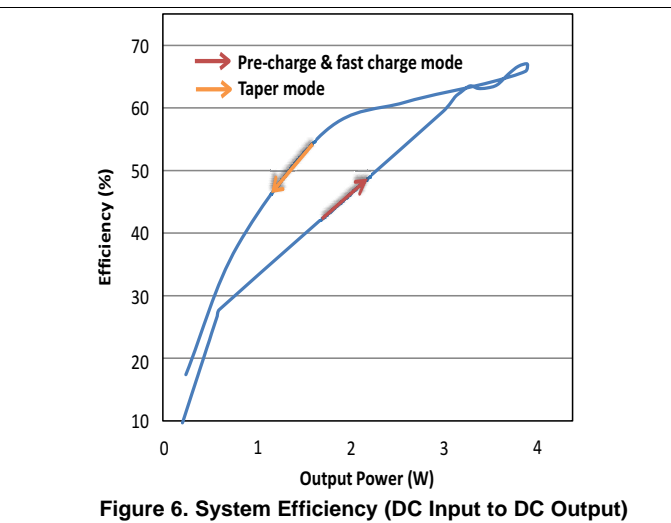
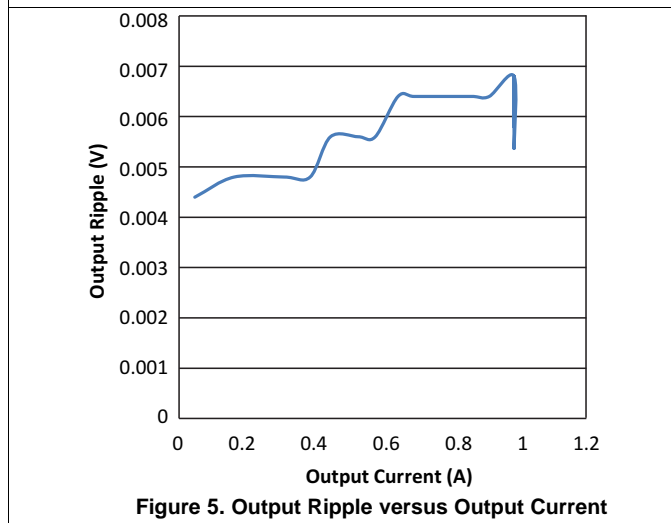
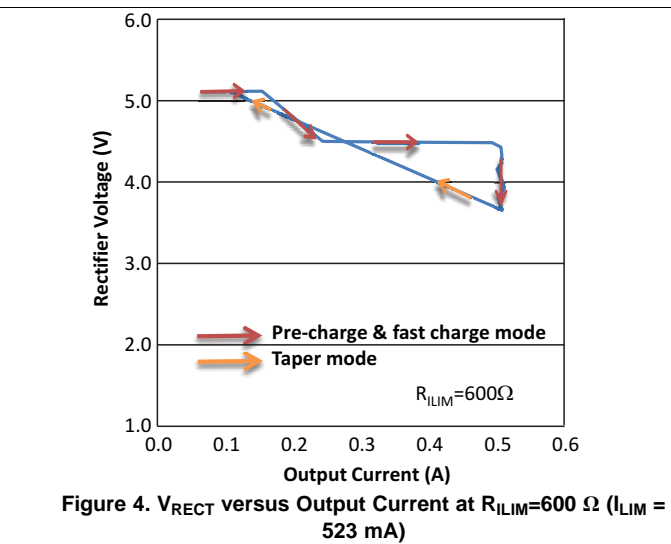
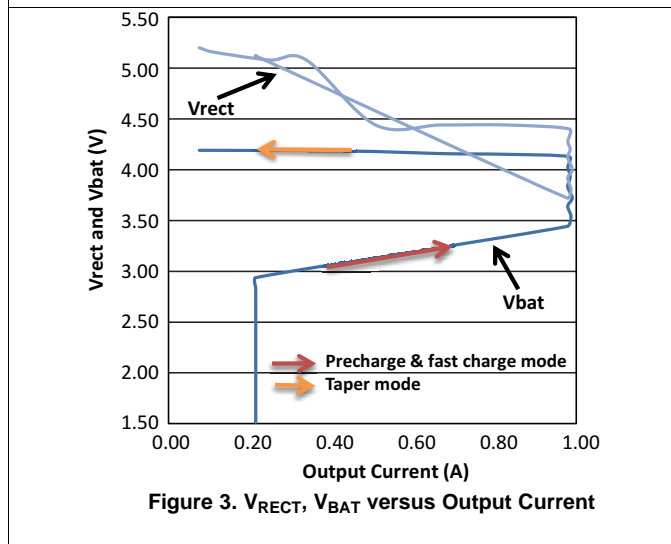
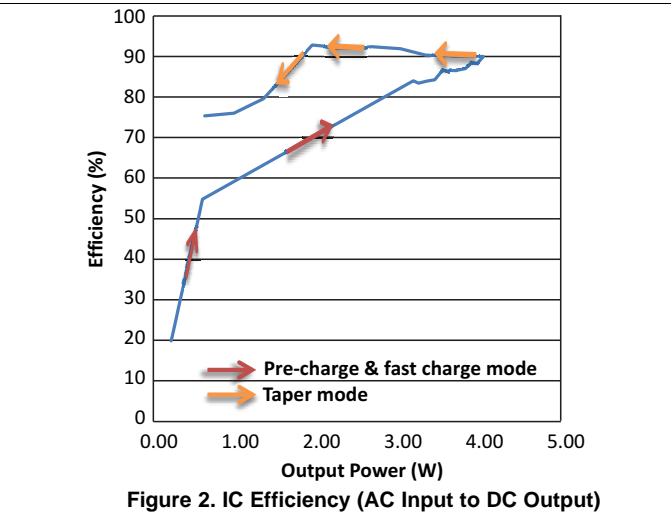
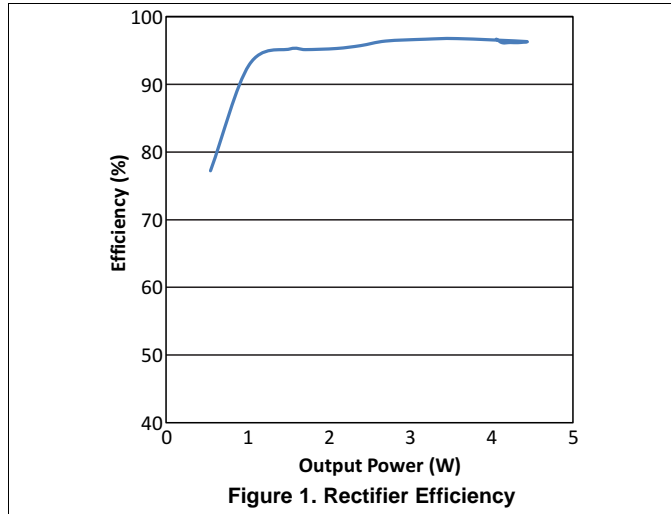

Typical Characteristics (continued)

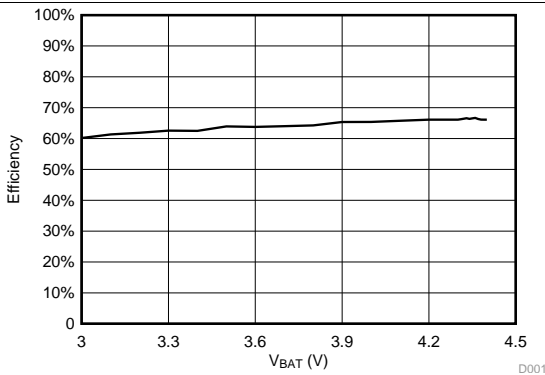

Figure 7. bq51052B 300-mA Fast Charge Efficiency (DC Input to DC Output)

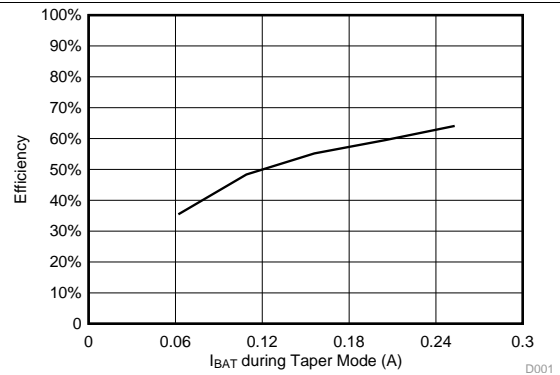

Figure 8. bq51052B 300-mA Taper Charge Efficiency (DC Input to DC Output)

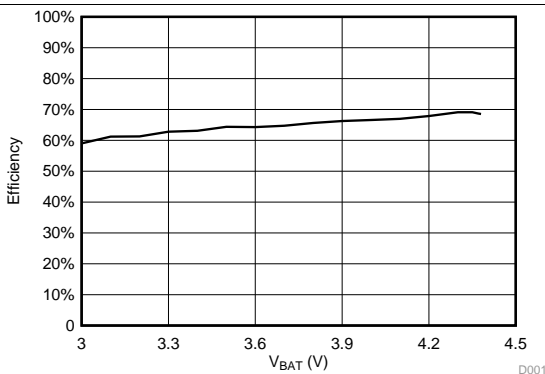

Figure 9. bq51052B 800-mA Fast Charge Efficiency (DC Input to DC Output)

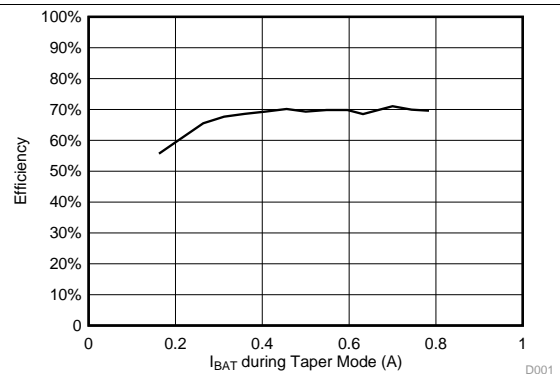

Figure 10. bq51052B 800-mA Taper Charge Efficiency (DC Input to DC Output)

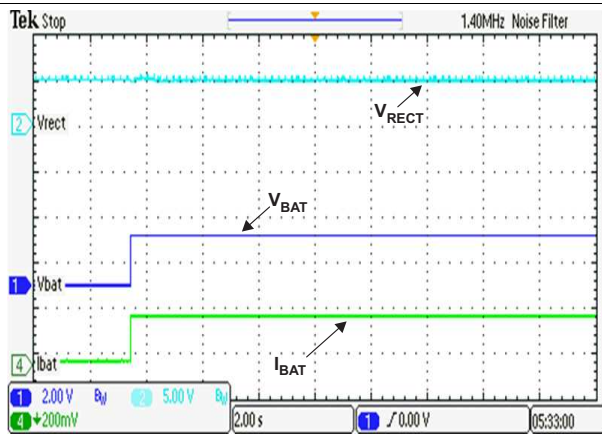

Figure 11. Battery Insertion in Precharge Mode

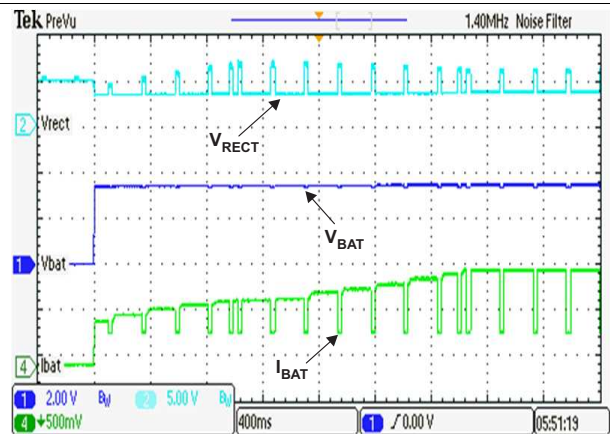

Figure 12. Battery Insertion in Fast-Charge Mode

Typical Characteristics (continued)

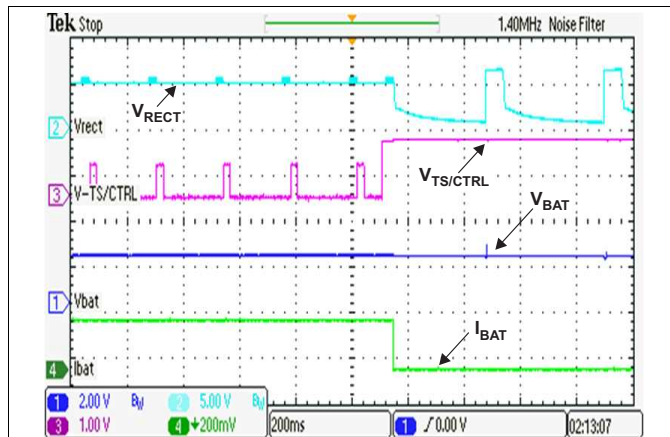

Figure 13. TS Fault

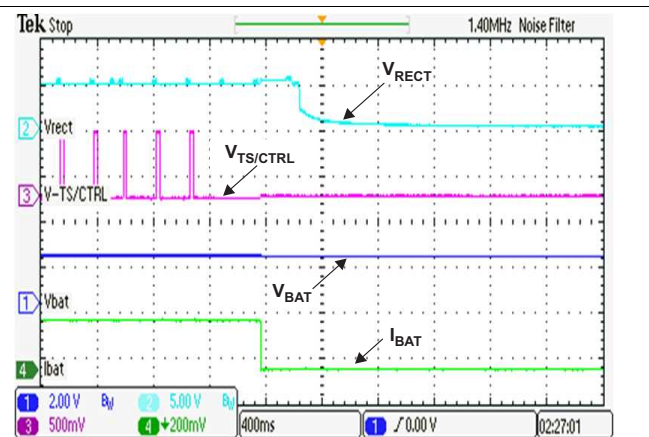

Figure 14. TS Ground Fault

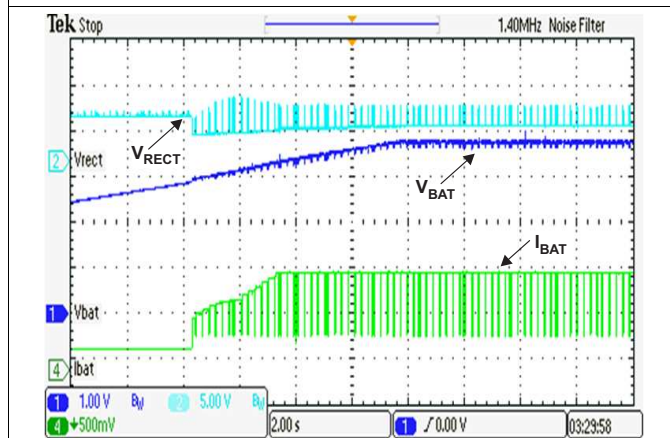

Figure 15. Precharge to Fast-Charge Transition

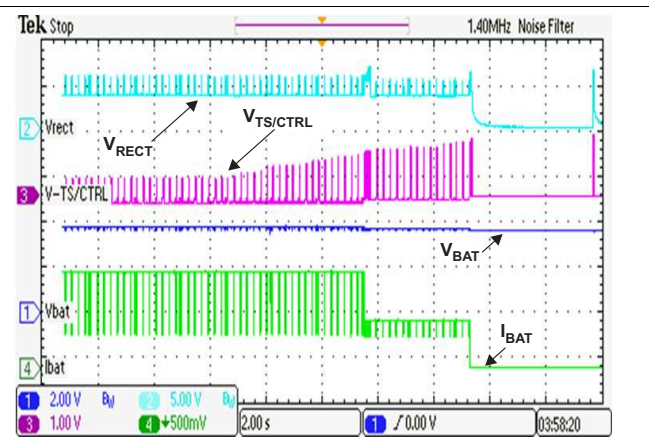

Figure 16. JEITA Functionality (Rising Temp) - bq51050B/bq51051B

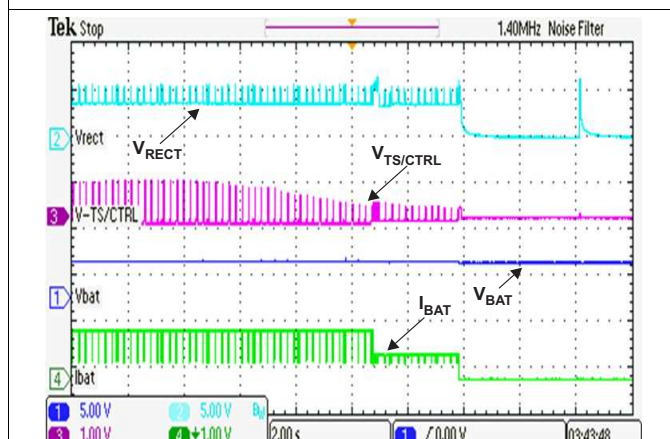

Figure 17. JEITA Functionality (Falling Temp) - bq51050B/bq51051B

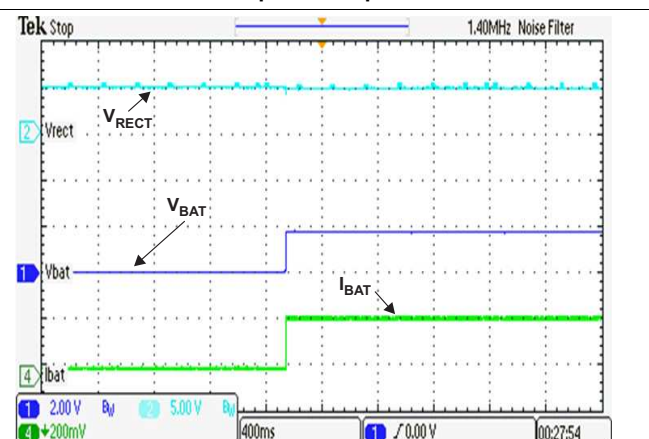

Figure 18. Battery Short to Precharge Mode Transition

## 8 Detailed Description

### 8.1 Overview

#### 8.1.1 A Brief Description of the Wireless System

A wireless system consists of a charging pad (primary, transmitter) and the secondary-side equipment. There are coils in the charging pad and in the secondary equipment which magnetically couple to each other when the equipment is placed on the charging pad. Power is transferred from the primary to the secondary by transformer action between the coils. Control over the amount of power transferred is achieved by changing the frequency of the primary drive.

The secondary can communicate with the primary by changing the load seen by the primary. This load variation results in a change in the primary coil current, which is measured and interpreted by a processor in the charging pad. The communication is digital - packets are transferred from the secondary to the primary. Differential bi-phase encoding is used for the packets. The rate is 2-kbps.

Various types of communication packets have been defined. These include identification and authentication packets, error packets, control packets, power usage packets, end of power packet and efficiency packets.

The primary coil is powered off most of the time. It wakes up occasionally to see if a secondary is present. If a secondary authenticates itself to the primary, the primary remains powered up. The secondary maintains full control over the power transfer using communication packets.

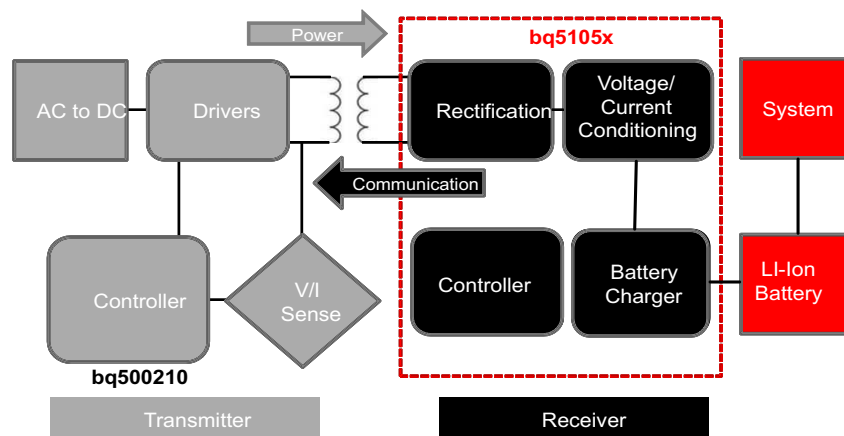
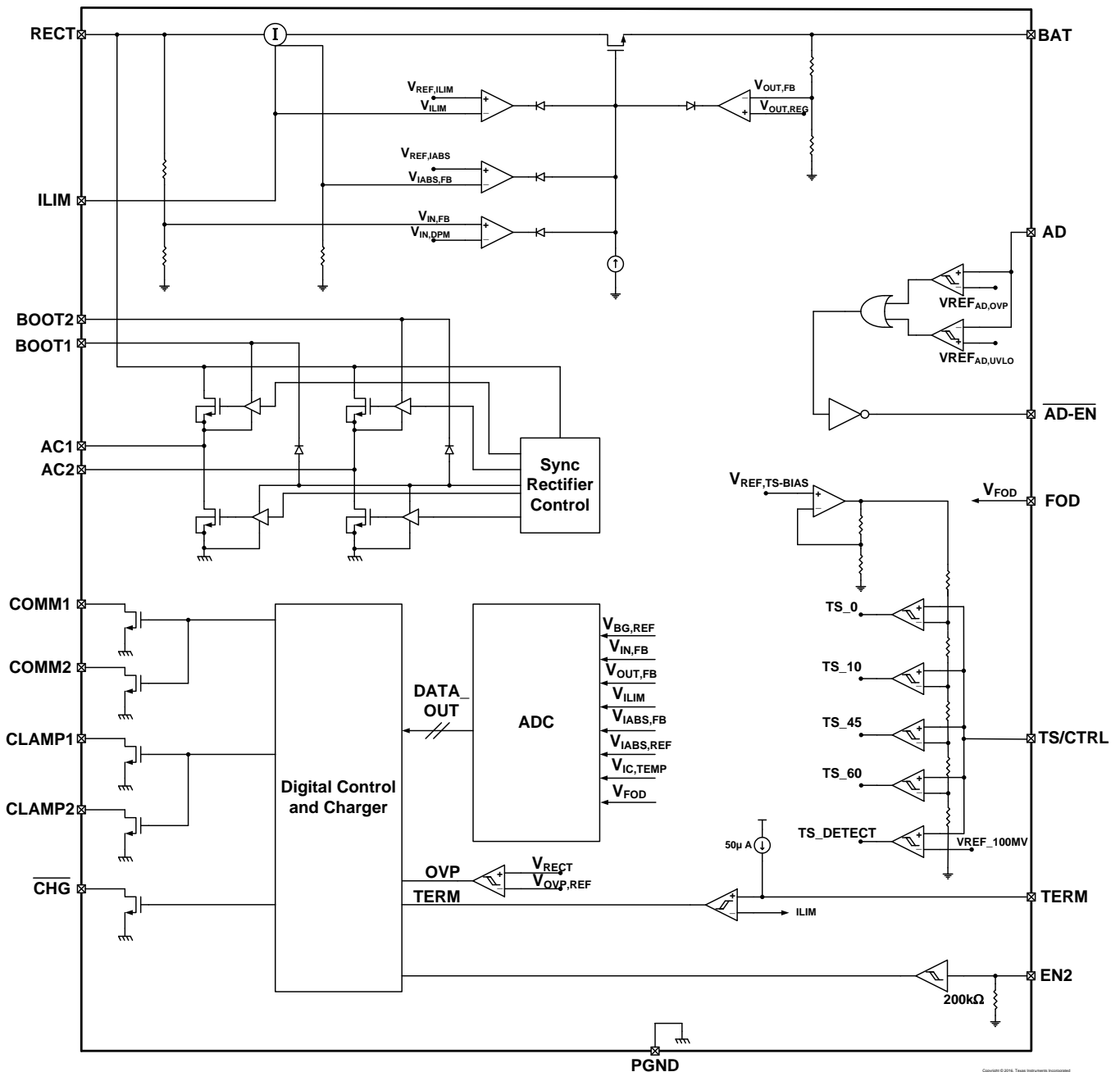

Figure 19. WPC Wireless Power Charging System Indicating the Functional Integration of the bq5105x

## 8.2 Functional Block Diagram



## 8.3 Feature Description

### 8.3.1 Using the bq5105x as a Wireless Li-Ion/Li-Pol Battery Charger (With Reference to *Functional Block Diagram*)

*Functional Block Diagram* is the schematic of a system which uses the bq5105x as a direct battery charger. When the system shown in *Functional Block Diagram* is placed on the charging pad (transmitter), the receiver coil couples to the magnetic flux generated by the coil in the charging pad which consequently induces a voltage in the receiver coil. The internal synchronous rectifier feeds this voltage to the RECT pin which has the filter capacitor  $C_3$ .

## Feature Description (continued)

The bq5105x identifies and authenticates itself to the primary using the COMM pins by switching on and off the COMM FETs and hence switching in and out  $C_{COMM}$ . If the authentication is successful, the transmitter will remain powered on. The bq5105x measures the voltage at the RECT pin, calculates the difference between the actual voltage and the desired voltage  $V_{RECT-REG}$  and sends back error packets to the primary. This process goes on until the RECT voltage settles at  $V_{RECT-REG}$ .

During power-up, the LDO is held off until the  $V_{RECT-REG}$  threshold converges. The voltage control loop ensures that the output (BAT) voltage is maintained at  $V_{BAT-REG}$ . The values of  $V_{BAT}$  and  $V_{RECT}$  are dependant on the battery charge mode. The bq5105x continues to monitor the  $V_{RECT}$  and  $V_{BAT}$  and sends error packets to the primary every 250 ms. The bq5105x regulates the  $V_{RECT}$  voltage very close to battery voltage, this voltage tracking process minimizes the voltage difference across the internal LDO and maximizes the charging efficiency. If a large transient occurs, the feedback to the primary speeds up to every 32 ms in order to converge on an operating point in less time.

### 8.3.2 Details of a Qi Wireless Power System and bq5105xB Power Transfer Flow Diagrams

The bq5105xB integrates a fully compliant WPC v1.2 communication algorithm in order to streamline receiver designs (no extra software development required). Other unique algorithms such as Dynamic Rectifier Control are also integrated to provide best-in-class system performance. This section provides a high level overview of these features by illustrating the wireless power transfer flow diagram from start-up to active operation.

During start-up operation, the wireless power receiver must comply with proper handshaking to be granted a power contract from the TX. The TX will initiate the handshake by providing an extended digital ping. If an RX is present on the TX surface, the RX will then provide the signal strength, configuration and identification packets to the TX (see volume 1 of the WPC specification for details on each packet). These are the first three packets sent to the TX. The only exception is if there is a shutdown condition on the EN1/EN2, AD, or TS/CTRL pins where the Rx will shut down the TX immediately. Once the TX has successfully received the signal strength, configuration and identification packets, the RX will be granted a power contract and is then allowed to control the operating point of the power transfer. With the use of the bq5105xB Dynamic Rectifier Control algorithm, the RX will inform the TX to adjust the rectifier voltage above 5 V before enabling the output supply. This method enhances the transient performance during system start-up. See [Figure 20](#) for the start-up flow diagram details.

Feature Description (continued)

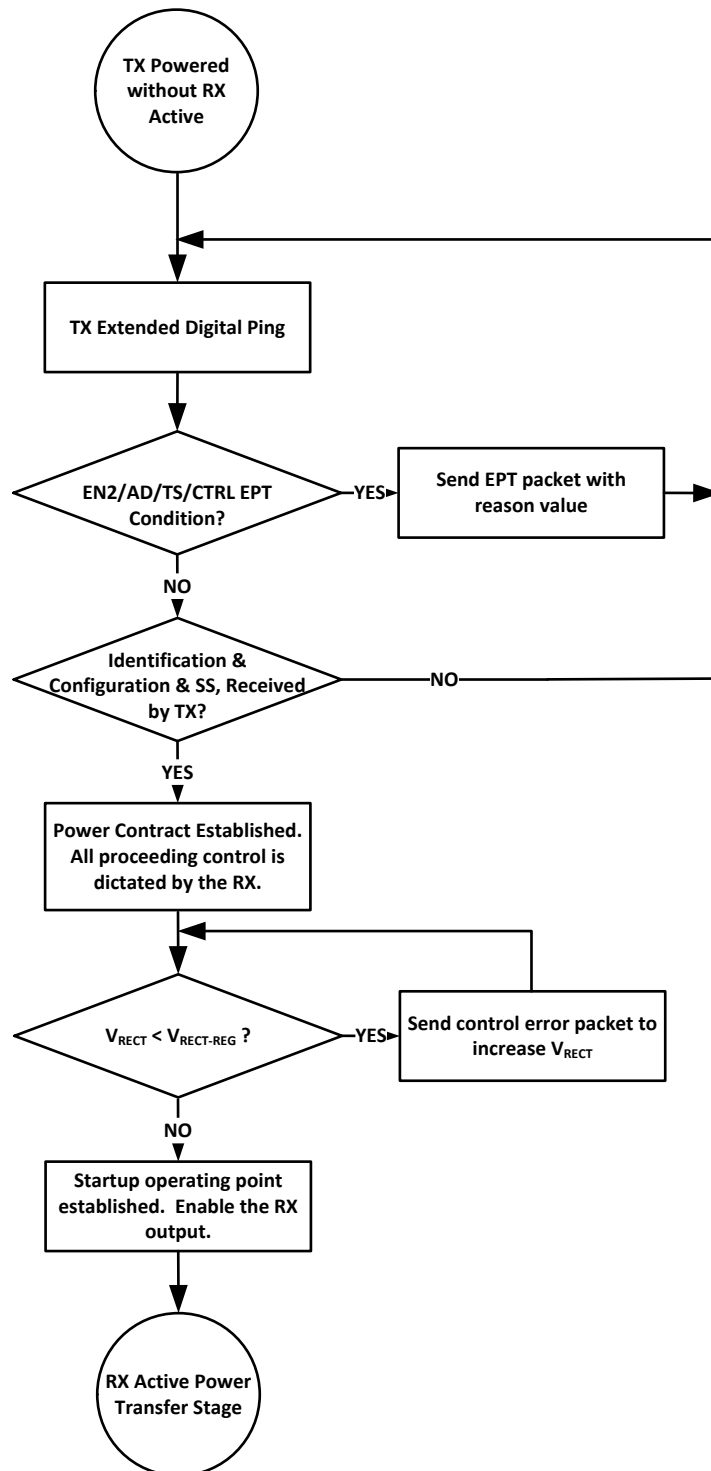

Figure 20. Wireless Power Start-up Flow Diagram



Feature Description (continued)

Once the start-up procedure has been established, the RX will enter the active power transfer stage. This is considered the “main loop” of operation. The Dynamic Rectifier Control algorithm will determine the rectifier voltage target based on a percentage of the maximum output current level setting (set by  $K_{ILIM}$  and the  $I_{ILIM}$  resistance to PGND). The RX will send control error packets in order to converge on these targets. As the output current changes, the rectifier voltage target will dynamically change. As a note, the feedback loop of the WPC system is relatively slow where it can take up to 90 ms to converge on a new rectifier voltage target. It should be understood that the instantaneous transient response of the system is open loop and dependent on the RX coil output impedance at that operating point. More details on this will be covered in the section Receiver Coil Load-Line Analysis. The “main loop” will also determine if any conditions are true and will then discontinue the power transfer. Figure 21 shows the active power transfer loop.

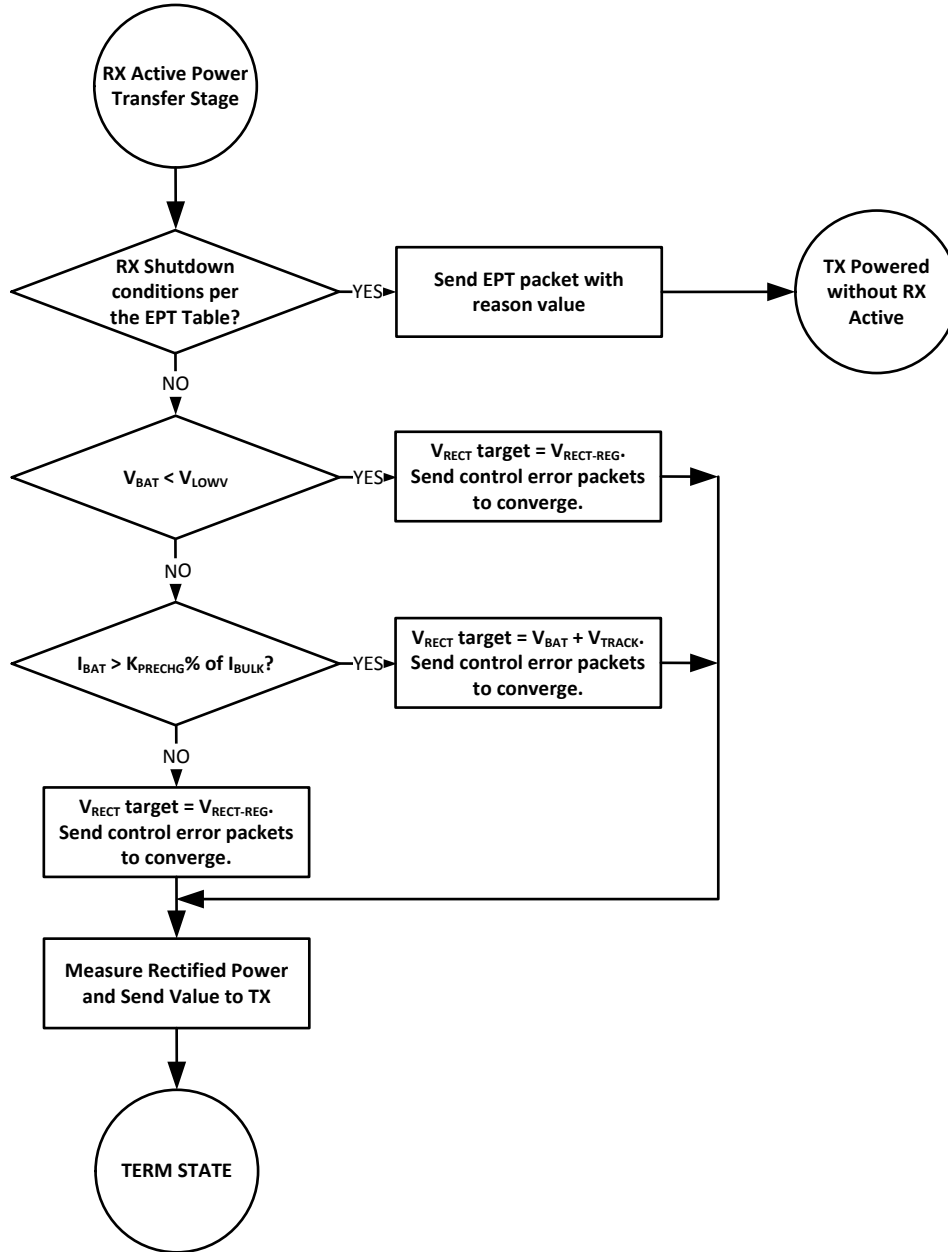

Figure 21. Active Power Transfer Flow Diagram

Feature Description (continued)

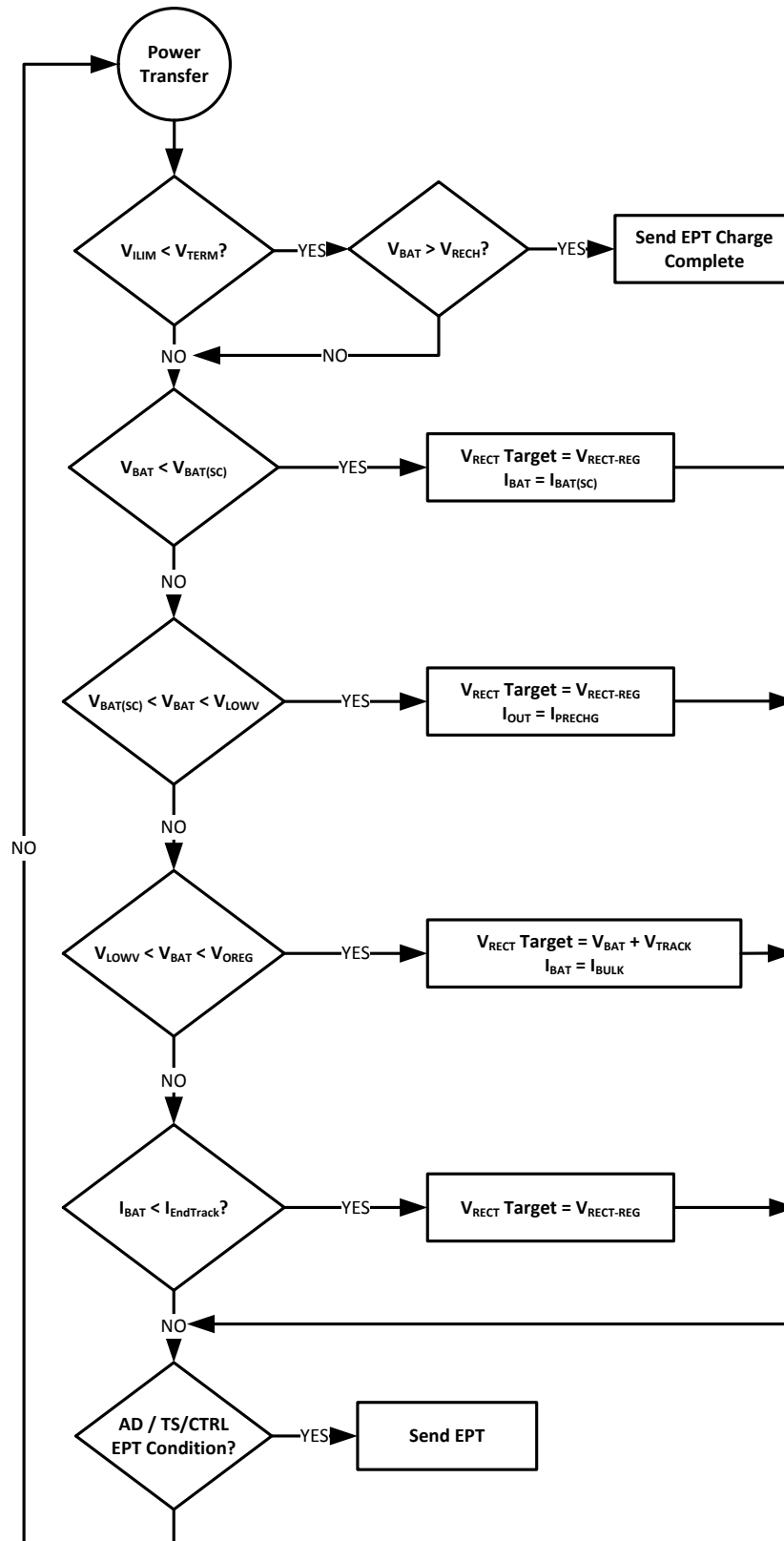

Figure 22. TERM STATE Flow Diagram of bq5105XB

## Feature Description (continued)

### 8.3.3 Battery Charge Profile

The battery is charged in three phases: precharge, fast-charge constant current and constant voltage. A voltage-based battery pack thermistor monitoring input (TS function of the TS/CTRL pin) is included that monitors battery temperature for safe charging. The TS function for bq51050B and bq51051B is JEITA compatible. The TS function for the bq51052B modifies the current regulation differently than standard JEITA. See [Battery-Charger Safety and JEITA Guidelines](#) for more details.

The rectifier voltage follows  $V_{BAT} + V_{TRACK}$  for any battery voltage above  $V_{LOWV}$  to full regulation voltage and most of the taper charging phase. If the battery voltage is below  $V_{LOWV}$  the rectifier voltage increases to  $V_{RECT-REG}$ .

If  $I_{BAT}$  is less than  $I_{EndTrack}$  (a percentage of  $I_{BULK}$ ) during taper mode, the rectifier voltage increases to  $V_{RECT-REG}$ .

The charge profile for the bq51050B and bq51051B is shown in [Figure 23](#) while the bq51052B is shown in [Figure 24](#).

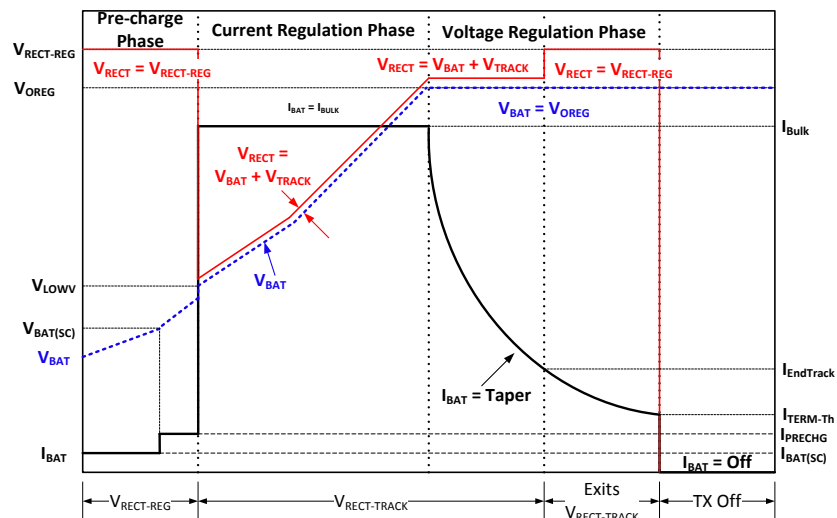

Figure 23. bq51050B and bq51051B Li-Ion Battery Charge Profile

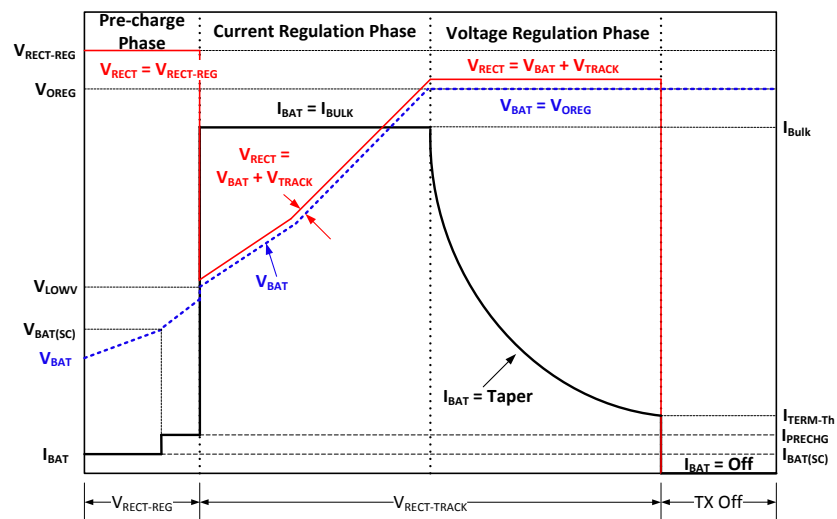

Figure 24. bq51052B Li-Ion Battery Charge Profile

## Feature Description (continued)

### 8.3.4 Battery Charging Process

#### 8.3.4.1 Precharge Mode ( $V_{BAT} \leq V_{LOWV}$ )

The bq5105X enters precharge mode when  $V_{BAT} \leq V_{LOWV}$ . Upon entering precharge mode, battery charge current limit is set to  $I_{PRECHG}$ . During precharge mode, the charge current is regulated to  $K_{PRECHG}$  percent of the fast charge current ( $I_{BULK}$ ) setting. For example, if  $I_{BULK}$  is set to 800 mA, then the precharge current would have a typical value of 160 mA.

If the battery is deeply discharged or shorted ( $V_{BAT} < V_{BAT(SC)}$ ), the bq5105X applies  $I_{BAT(SC)}$  current to bring the battery voltage up to acceptable charging levels. Once the battery rises above  $V_{BAT(SC)}$ , the charge current is regulated to  $I_{PRECHG}$ .

Under normal conditions, the time spent in this precharge region is a very short percentage of the total charging time and this does not affect the overall charging efficiency for very long.

#### 8.3.4.2 Fast Charge Mode / Constant Voltage Mode

Once  $V_{BAT} > V_{LOWV}$ , the bq5105x enters fast charge mode (Current Regulation Phase) where charge current is regulated using the internal MOSFETs between RECT and BAT. Once the battery voltage charges up to  $V_{BAT-REG}$ , the bq5105x enters constant voltage (CV) phase and regulates battery voltage to  $V_{OREG}$  and the charging current is reduced.

Once  $I_{BAT}$  falls below the termination threshold ( $I_{TERM-TH}$ ), the charger sends an EPT (Charge Complete) notification to the TX and enters high impedance mode.

#### 8.3.4.3 Battery Charge Current Setting Calculations

##### 8.3.4.3.1 $R_{ILIM}$ Calculations

The bq5105x includes a means of providing hardware overcurrent protection by means of an analog current regulation loop. The hardware current limit provides an extra level of safety by clamping the maximum allowable output current (for example, a current compliance). The calculation for the total  $R_{ILIM}$  resistance is as follows:

$$R_1 = \frac{K_{ILIM}}{I_{BULK}} - R_{FOD} \qquad R_{ILIM} = R_1 + R_{FOD} \qquad I_{BULK} = \frac{K_{ILIM}}{R_{ILIM}} \qquad (1)$$

Where  $I_{BULK}$  is the programmed battery charge current during fast charge mode. When referring to the application diagram shown in [Figure 32](#),  $R_{ILIM}$  is the sum of  $R_{FOD}$  and  $R_1$  (the total resistance from the ILIM pin to PGND).

##### 8.3.4.3.2 Termination Calculations

The bq5105X includes a programmable upper termination threshold. The upper termination threshold is calculated using [Equation 2](#):

$$R_{TERM} = K_{TERM} * \%I_{BULK} \qquad \%I_{BULK} = \frac{R_{TERM}}{K_{TERM}} \qquad (2)$$

The  $K_{TERM}$  constant is specified in [Electrical Characteristics](#) as 240  $\Omega$ /%. The upper termination threshold is set as a percentage of the charge current setting ( $I_{BULK}$ ).

For example, if  $R_{ILIM}$  is set to 314  $\Omega$ ,  $I_{BULK}$  will be 1 A ( $314 \div 314$ ). If the upper termination threshold is desired to be 100 mA, this would be 10% of  $I_{BULK}$ . The  $R_{TERM}$  resistor would then equal 2.4 k $\Omega$  ( $240 \times 10$ ).

Termination can be disabled by floating the TERM pin. If the TERM pin is grounded the termination function is effectively disabled. However, due to offsets of internal comparators, termination may occur at low battery currents.

## Feature Description (continued)

### 8.3.4.4 Battery-Charger Safety and JEITA Guidelines

The bq5105x continuously monitors battery temperature by measuring the voltage between the TS/CTRL pin and PGND. A negative temperature coefficient thermistor (NTC) and an external voltage divider typically develop this voltage. The bq5105x compares this voltage against its internal thresholds to determine if charging is allowed. To initiate a charge cycle, the voltage on TS/CTRL pin ( $V_{TS}$ ) must be within the  $V_{T1}$  to  $V_{T4}$  thresholds. If  $V_{TS}$  is outside of this range, the bq5105x suspends charge and waits until the battery temperature is within the  $V_{T1}$  to  $V_{T4}$  range. Additional information on the Temperature Sense function can be found in [Internal Temperature Sense \(TS Function of the TS/CTRL Pin\)](#).

#### 8.3.4.4.1 bq51050B and bq51051B JEITA

If  $V_{TS}$  is within the ranges of  $V_{T1}$  and  $V_{T2}$  or  $V_{T3}$  and  $V_{T4}$ , the charge current is reduced to  $I_{BULK}/2$ . If  $V_{TS}$  is within the range of  $V_{T1}$  and  $V_{T3}$ , the maximum charge voltage regulation is  $V_{OREG}$ . If  $V_{TS}$  is within the range of  $V_{T3}$  and  $V_{T4}$ , the maximum charge voltage regulation is reduced to "NEW SPEC". [Figure 25](#) summarizes the operation.

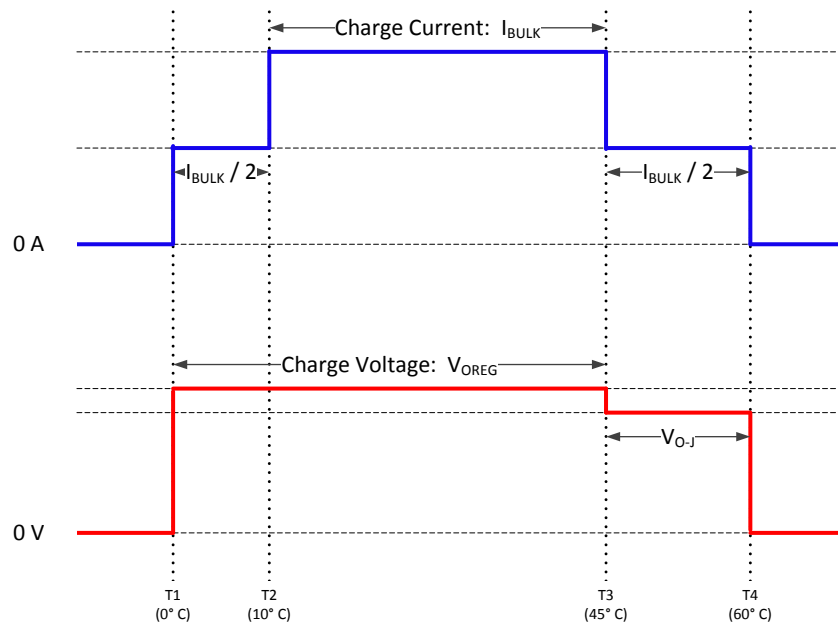
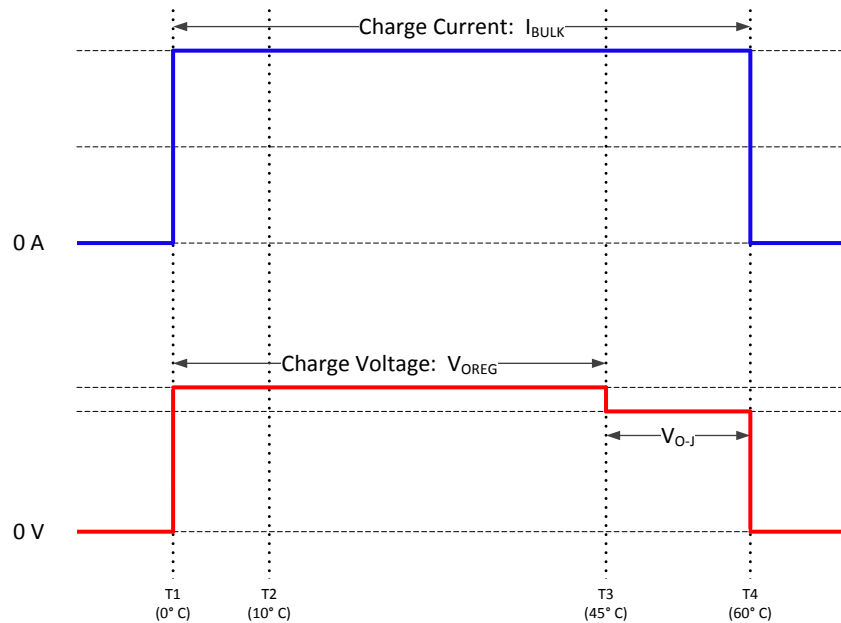

Figure 25. JEITA Compatible TS Profile for bq51050B and bq51051B

#### 8.3.4.4.2 bq51052B Modified JEITA

The bq51052B has a modified JEITA profile. The maximum charge current is not modified between  $V_{T1}$  and  $V_{T2}$  or between  $V_{T3}$  and  $V_{T4}$ , it remains at  $I_{BULK}$ . The maximum charge voltage is reduced to  $V_{O-J}$  when the  $V_{TS}$  is between  $V_{T3}$  and  $V_{T4}$ .

**Feature Description (continued)**

**Figure 26. JEITA Compatible TS Profile for bq51052B**
**8.3.4.5 Input Overvoltage**

If, for some condition (for example, a change in position of the equipment on the charging pad), the rectifier voltage suddenly increases in potential, the voltage-control loop inside the bq5105x becomes active, and prevents the output from going beyond  $V_{BAT-REG}$ . The receiver then starts sending back error packets every 32 ms until the RECT voltage comes back to an acceptable level, and then maintains the error communication every 250 ms.

If the input voltage increases in potential beyond  $V_{OVP}$ , the device switches off the internal FET and communicates to the primary to bring the voltage back to  $V_{RECT-REG}$ . In addition a proprietary voltage protection circuit is activated by means of  $C_{CLAMP1}$  and  $C_{CLAMP2}$  that protects the device from voltages beyond the maximum rating.

**8.3.4.6 End Power Transfer Packet (WPC Header 0x02)**

The WPC allows for a special command to terminate power transfer from the TX termed End Power Transfer (EPT) packet. WPC v1.2 specifies the reasons for sending a termination packet and their data field value. In [Table 1](#), the CONDITION column corresponds to the stimulus causing the bq5105x device to send the hexadecimal code in the VALUE column.

**Table 1. Termination Packets**

REASON	VALUE	CONDITION
Unknown	0x00	$AD > V_{AD-PreS}$ , $TS/CTRL = V_{CTRL-HI}$
Charge Complete	0x01	$I_{BAT}$ falls below $I_{TERM-Th}$ during Taper mode
Internal Fault	0x02	$T_J > 150^\circ\text{C}$ or $R_{ILIM} < R_{ILIM-SHORT}$
Overtemperature	0x03	$TS < V_{HOT}$ , $TS > V_{COLD}$ , or $TS/CTRL < V_{CTRL-LOW}$
Overvoltage	0x04	Not Sent
Overcurrent	0x05	Not Sent
Battery failure	0x06	Battery is not coming out of precharge mode after Precharge time-out, or fast charge time-out has occurred.
Reconfigure	0x07	Not Sent
No Response	0x08	$V_{RECT}$ target does not converge

### 8.3.4.7 Status Output

The bq5105x provides one status output,  $\overline{\text{CHG}}$ . This output is an open-drain NMOS device that is rated to 20 V. The open-drain FET connected to the  $\overline{\text{CHG}}$  pin will be turned on whenever the output (BAT) of the charger is enabled. As a note, the output of the charger supply will not be enabled if the  $V_{\text{RECT-REG}}$  does not converge to the no-load target voltage.

### 8.3.4.8 Communication Modulator

The bq5105x provides two identical, integrated communication FETs which are connected to the pins COMM1 and COMM2. These FETs are used for modulating the secondary load current which allows bq5105x to communicate error control and configuration information to the transmitter. There are two methods to implement load modulation, capacitive and resistive.

Capacitive load modulation is more commonly used. Capacitive load modulation is shown in Figure 27. In this case, a capacitor is connected from COMM1 to AC1 and from COMM2 to AC2. When the COMM switches are closed there is effectively a 22 nF capacitor connected between AC1 and AC2. Connecting a capacitor in between AC1 and AC2 modulates the impedance seen by the coil, which will be reflected to the primary and interpreted by the controller as a change in current.

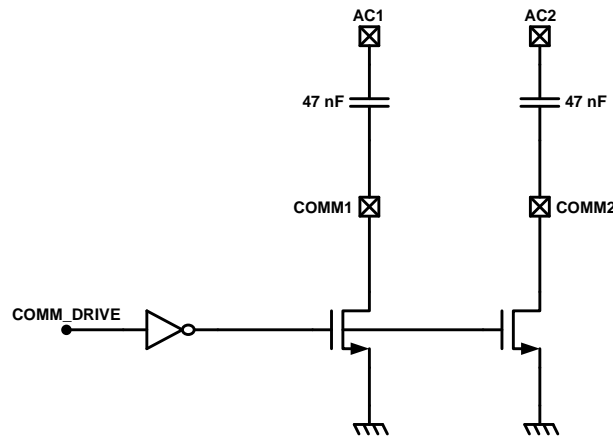

Figure 27. Capacitive Load Modulation

Figure 28 shows how the COMM pins can be used for resistive load modulation. Each COMM pin can handle at most a 24  $\Omega$  communication resistor. Therefore, if a COMM resistor between 12  $\Omega$  and 24  $\Omega$  is required, COMM1 and COMM2 pins must be connected in parallel. bq5105x does not support a COMM resistor less than 12  $\Omega$ .

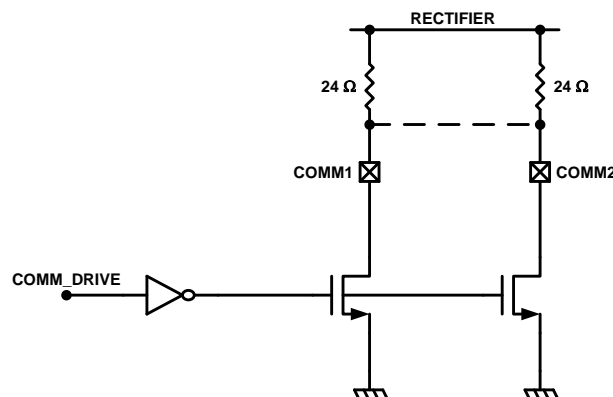

Figure 28. Resistive Load Modulation

### 8.3.4.9 Adaptive Communication Limit

The Qi communication channel is established through backscatter modulation as described in the previous sections. This type of modulation takes advantage of the loosely coupled inductor relationship between the RX and TX coils. Essentially, the switching in-and-out of the communication capacitor or resistor adds a transient load to the RX coil in order to modulate the TX coil voltage and current waveform (amplitude modulation). The consequence of this technique is that a load transient (load current noise) from the mobile device has the same signature. To provide noise immunity to the communication channel, the output load transients must be isolated from the RX coil. The proprietary feature *Adaptive Communication Limit* achieves this by dynamically adjusting the current limit of the regulator.

This can be seen in [Figure 12](#). In this plot, an output load is limited to 400 mA during communications time. The pulses on  $V_{RECT}$  indicate that a communication packet event is occurring. The regulator limits the load to a constant 400 mA and, therefore, preserves communication.

### 8.3.4.10 Synchronous Rectification

The bq5105x provides an integrated, self-driven synchronous rectifier that enables high-efficiency AC to DC power conversion. The rectifier consists of an all NMOS H-Bridge driver where the back gates of the diodes are configured to be the rectifier when the synchronous rectifier is disabled. During the initial start-up of the WPC system the synchronous rectifier is not enabled. At this operating point, the DC rectifier voltage is provided by the diode rectifier. Once  $V_{RECT}$  is greater than  $V_{UVLO}$ , half synchronous mode will be enabled until the load current surpasses  $I_{BAT-SR}$ . Above  $I_{BAT-SR}$  the full synchronous rectifier stays enabled until the load current drops back below the hysteresis level ( $I_{BAT-SRH}$ ) where half synchronous mode is re-enabled.

### 8.3.4.11 Internal Temperature Sense (TS Function of the TS/CTRL Pin)

The bq5105x includes a ratiometric battery temperature sense circuit. The temperature sense circuit has two ratiometric thresholds which represent hot and cold conditions. An external temperature sensor is recommended to provide safe operating conditions to the receiver product. This pin is best used when monitoring the battery temperature.

The circuits in [Figure 29](#) allow for any NTC resistor to be used with the given  $V_{HOT}$  and  $V_{COLD}$  thresholds. The thermister characteristics and threshold temperatures selected will determine which circuit is best for an application.

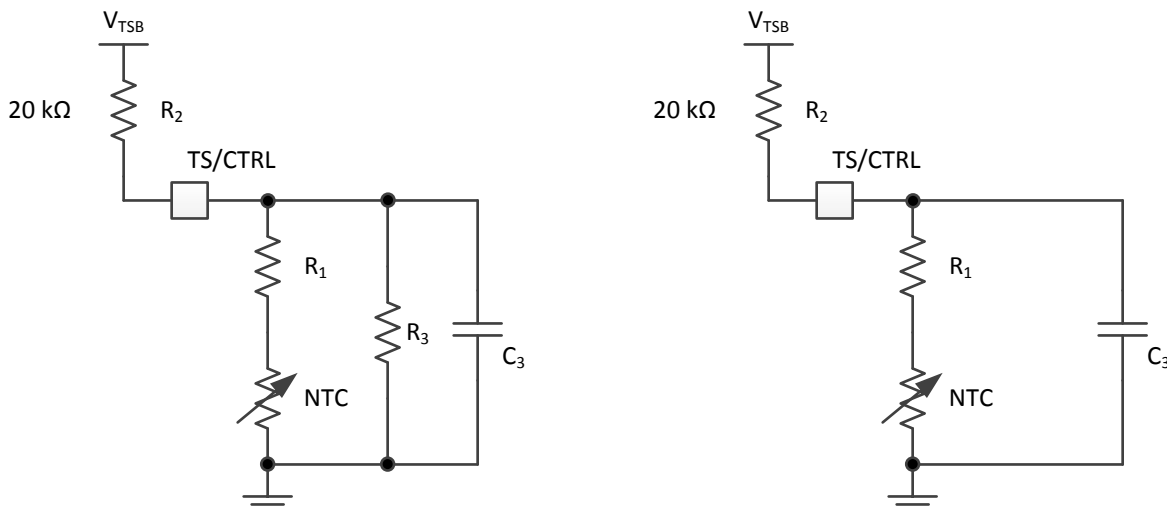

**Figure 29. NTC Circuit Options for Safe Operation of the Wireless Receiver Power Supply**



The resistors R1 and R3 can be solved by resolving the system of equations at the desired temperature thresholds. The two equations are:

$$\%V_{\text{COLD}} = \frac{\left( \frac{R_3 (R_{\text{NTC}}|_{\text{TCOLD}} + R_1)}{R_3 + (R_{\text{NTC}}|_{\text{TCOLD}} + R_1)} \right)}{\left( \frac{R_3 (R_{\text{NTC}}|_{\text{TCOLD}} + R_1)}{R_3 + (R_{\text{NTC}}|_{\text{TCOLD}} + R_1)} \right) + R_2} \times 100 \quad (3)$$

$$\%V_{\text{HOT}} = \frac{\left( \frac{R_3 (R_{\text{NTC}}|_{\text{THOT}} + R_1)}{R_3 + (R_{\text{NTC}}|_{\text{THOT}} + R_1)} \right)}{\left( \frac{R_3 (R_{\text{NTC}}|_{\text{THOT}} + R_1)}{R_3 + (R_{\text{NTC}}|_{\text{THOT}} + R_1)} \right) + R_2} \times 100 \quad (4)$$

Where:

$$R_{\text{NTC}}|_{\text{TCOLD}} = R_0 e^{\beta \left( \frac{1}{\text{TCOLD}} - \frac{1}{T_0} \right)}$$

$$R_{\text{NTC}}|_{\text{THOT}} = R_0 e^{\beta \left( \frac{1}{\text{THOT}} - \frac{1}{T_0} \right)}$$

$T_{\text{COLD}}$  and  $T_{\text{HOT}}$  are the desired temperature thresholds in degrees Kelvin.  $R_0$  is the nominal resistance at  $T_0$  (25°C) and  $\beta$  is the temperature coefficient of the NTC resistor. For an example solution for part number ERT-JZEG103JA see the [BQ5105XB NTC Calculator Tool, \(SLUS629\)](#).

Where,

$$T_{\text{COLD}} = 0^\circ\text{C} (273.15^\circ\text{K})$$

$$T_{\text{HOT}} = 60^\circ\text{C} (333.15^\circ\text{K})$$

$$\beta = 3380$$

$$R_0 = 10 \text{ k}\Omega$$

The plot of the percent  $V_{\text{TSB}}$  versus temperature is shown in [Figure 30](#):

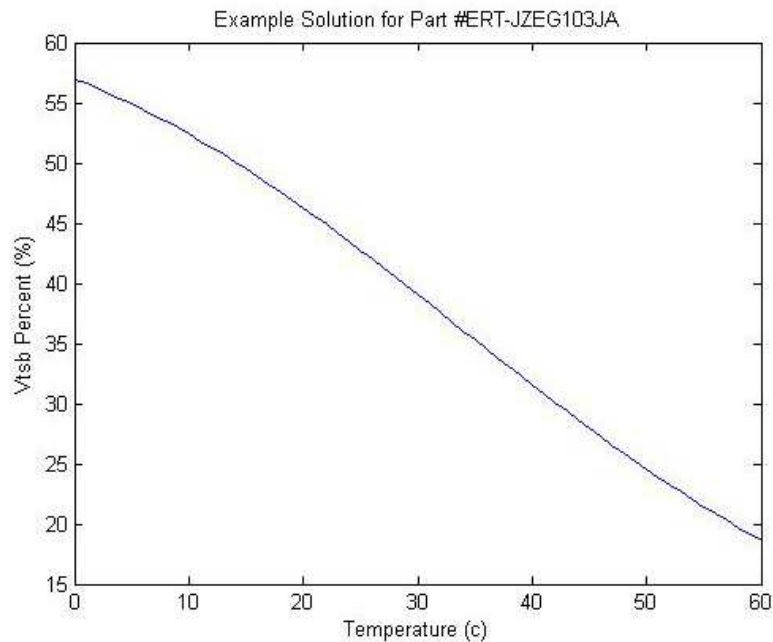

**Figure 30. Example Solution for Panasonic Part # ERT-JZEG103JA**

Figure 31 shows the periodic biasing scheme used for measuring the TS state. An internal TS\_READ signal enables the TS bias voltage for 25 ms. During this period the TS comparators are read (each comparator has a 10-ms deglitch) and appropriate action is taken based on the temperature measurement. After this 25-ms period has elapsed the TS\_READ signal goes low, which causes the TS/CTRL pin to become high impedance. During the next 100-ms period, the TS voltage is monitored and compared to  $V_{CTRL-HI}$ . If the TS voltage is greater than  $V_{CTRL-HI}$  then a secondary device is driving the TS/CTRL pin and a CTRL = 1 is detected.

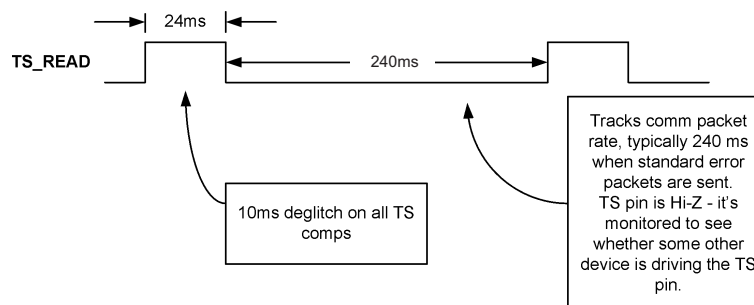

**Figure 31. Timing Diagram for TS Detection Circuit**

#### 8.3.4.11.1 TS/CTRL Function

The TS/CTRL pin offers three functions:

- NTC temperature monitoring
- Charge done indication
- Fault indication

When an NTC resistor is connected between the TS/CTRL pin and PGND, the NTC function is allowed to operate. This functionality can effectively be disabled by connecting a 10 kΩ resistor from TS/CTRL to PGND. If the TS/CTRL pin is pulled above  $V_{CTRL-HI}$ , the RX is shut down with the indication of a charge complete condition. If the TS/CTRL pin is pulled below  $V_{CTRL-LOW}$ , the RX is shut down with the indication of a fault.

### 8.3.4.11.2 Thermal Protection

The bq5105x includes thermal shutdown protection. If the die temperature reaches  $T_{J-SD}$ , the LDO is shut off to prevent any further power dissipation. Once the temperature falls  $T_{J-Hys}$  below  $T_{J-SD}$ , operation can continue.

### 8.3.4.12 WPC v1.2 Compatibility

The bq5105x is a WPC v1.2 compatible device. In order to enable a Power Transmitter to monitor the power loss across the interface as one of the possible methods to limit the temperature rise of Foreign Objects, the bq5105x reports its Received Power to the Power Transmitter. The Received Power equals the power that is available from the output of the Power Receiver plus any power that is lost in producing that output power. For example, the power loss includes (but is not limited to) the power loss in the Secondary Coil and series resonant capacitor, the power loss in the Shielding of the Power Receiver, the power loss in the rectifier, the power loss in any post-regulation stage, and the eddy current loss in metal components or contacts within the Power Receiver. In the WPC v1.2 specification, foreign object detection (FOD) is enforced, that means the bq5105x will send received power information with known accuracy to the transmitter.

WPC v1.2 defines Received Power as “the average amount of power that the Power Receiver receives through its Interface Surface, in the time window indicated in the Configuration Packet”.

A Receiver will be certified as WPC v1.2 only after meeting the following requirement. The device under test (DUT) is tested on a Reference Transmitter whose transmitted power is calibrated, the receiver must send a received power such that:

$$0 < (TX\ PWR)\ REF - (RX\ PWR\ out)\ DUT < 375\ mW \quad (5)$$

This 250 mW bias ensures that system will remain interoperable.

WPC v1.2 Transmitters will be tested to see if they can detect reference Foreign Objects with a Reference receiver. The WPC v1.2 specification allows much more accurate sensing of Foreign Objects than WPC v1.0.

A Transmitter can be certified as a WPC v1.2 only after meeting the following requirement. A Transmitter is tested to see if it can prevent some reference Foreign Objects (disc, coin, foil) from exceeding their threshold temperature (60°C, 80°C).

## 8.4 Device Functional Modes

The general modes of battery charging are described above in the [Feature Description](#). The bq5105x devices have several functional modes. Start-up refers to the initial power transfer and communication between the receiver (bq5105x circuit) and the transmitter. Power transfer refers to any time that the TX and RX are communicating and power is being delivered from the TX to the RX. Charge termination covers intentional termination (charge complete) and unintentional termination (removal of the RX from the TX, over temperature or other fault conditions).



## Typical Application (continued)

### 9.2.1.2 Detailed Design Procedure

#### 9.2.1.2.1 Series and Parallel Resonant Capacitor Selection

Shown in [Figure 33](#), the capacitors C1 (series) and C2 (parallel) make up the dual resonant circuit with the receiver coil. These two capacitors must be sized correctly per the WPC v1.2 specification. [Figure 33](#) shows the equivalent circuit of the dual resonant circuit:

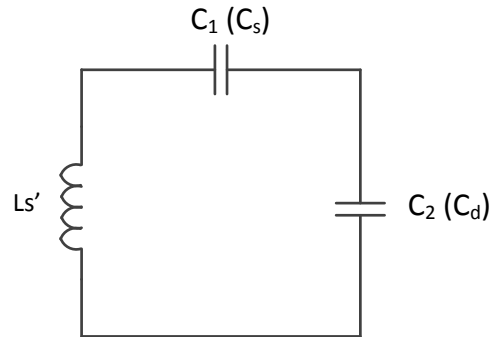

**Figure 33. Dual Resonant Circuit with the Receiver Coil**

The power receiver design requirements in volume 1 of the WPC v1.2 specification highlights in detail the sizing requirements. To summarize, the receiver designer will be required take inductance measurements with a fixed test fixture. The test fixture is shown in [Figure 34](#):

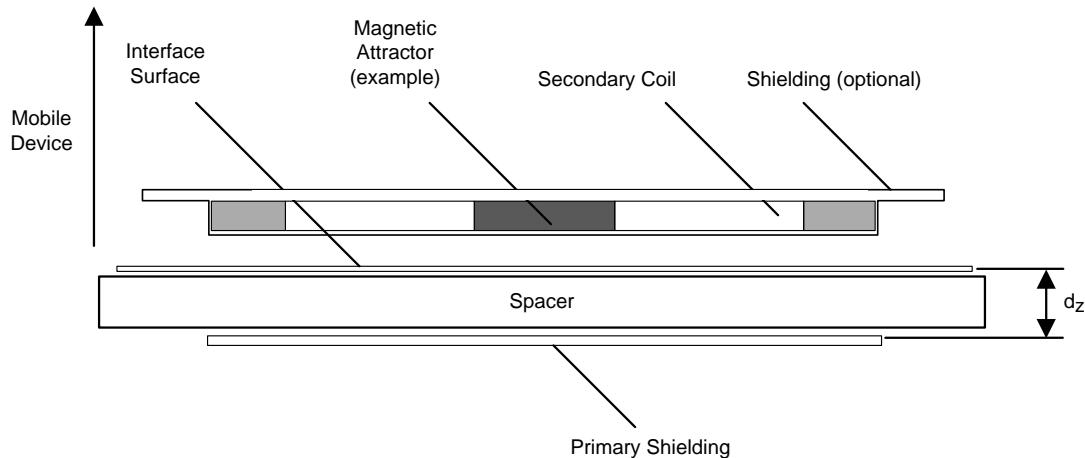

**Figure 34. WPC v1.2 Receiver Coil Test Fixture for the Inductance Measurement Ls'**

The primary shield is to be 50 mm x 50 mm x 1 mm of Ferrite material PC44 from TDK Corp. The gap (dz) is to be 3.4 mm. The receiver coil, as it will be placed in the final system (for example, the back cover and battery must be included if the system calls for this), is to be placed on top of this surface and the inductance is to be measured at 1-V RMS and a frequency of 100 kHz. This measurement is termed Ls'. The measurement termed Ls is the free-space inductance. Each capacitor can then be calculated using [Equation 6](#):

$$C_1 = \frac{1}{(2\pi \times f_s)^2 \times L'_s}$$

$$C_2 = \left( (f_D \times 2\pi)^2 \times L_s - \frac{1}{C_1} \right)^{-1} \quad (6)$$

Where  $f_s$  is 100 kHz +5/-10% and  $f_D$  is 1 MHz ±10%.  $C_1$  must be chosen first prior to calculating  $C_2$ . The quality factor must be greater than 77 and can be determined by [Equation 7](#):

## Typical Application (continued)

$$Q = \frac{2\pi \times f_D \times L_s}{R} \quad (7)$$

Where R is the DC resistance of the receiver coil. All other constants are defined above.

For this application, we will design with an inductance measurement (L) of 11  $\mu$ H and an Ls' of 16  $\mu$ H with a DC resistance of 191 m $\Omega$ . Plugging Ls' into [Equation 6](#) above, we get a value for C<sub>1</sub> to be 158.3 nF. The range on the capacitance is about 144 nF to 175 nF. To build the resulting value, the optimum solution is usually found with 3 capacitors in parallel. This allows for more precise selection of values, lower effective resistance and better thermal results. To get 158 nF, choose from standard values. In this case, the values are 68 nF, 47 nF and 39 nF for a total of 154 nF. Well in the required range. Now that C<sub>1</sub> is chosen, the value of C<sub>2</sub> can be calculated. The result of this calculation is 2.3 nF. The practical solution for this is 2 capacitors, a 2.2 nF capacitor and a 100 pF capacitor. In all cases, these capacitors must have at least a 25-V rating. Solving for the quality factor (Q) this solution shows a rating over 500.

### 9.2.1.2.2 COMM, CLAMP and BOOT Capacitors

For most applications, the COMM, CLAMP and BOOT capacitors will be chosen to match the Evaluation Module.

The BOOT capacitors are used to allow the internal rectifier FETs to turn on and off properly. These capacitors are on the AC1 or AC2 lines to the Boot nodes and should have a minimum of 10-V rating. A 10-nF capacitor with a 10-V rating is chosen.

The CLAMP capacitors are used to aid the clamping process to protect against overvoltage. Choosing a 0.47- $\mu$ F capacitor with a 25-V rating is appropriate for most applications.

The COMM capacitors are used to facilitate the communication from the RX to the TX. This selection can vary a bit more than the BOOT and CLAMP capacitors. In general, a 22-nF capacitor is recommended. Based on the results of testing of the communication robustness, a change to a 47-nF capacitor may be in order. The larger the capacitor the larger the deviation will be on the coil which sends a stronger signal to the TX. This also decreases the efficiency somewhat. In this case, choose the 22-nF capacitor with the 25-V rating.

### 9.2.1.2.3 Charging and Termination Current

The [Design Requirements](#) show an 800-mA charging current and an 80-mA termination current.

Setting the charge current (I<sub>BULK</sub>) is done by selecting the R<sub>1</sub> and R<sub>FOD</sub>. Solving [Equation 1](#) results in R<sub>ILIM</sub> of 393  $\Omega$ . Setting R<sub>FOD</sub> to 200  $\Omega$  as a starting point before the FOD calibration is recommended. This leaves 205  $\Omega$  for R<sub>1</sub>. Using standard resistor values (or resistors in series / parallel) can improve accuracy.

Setting the termination current is done with [Equation 2](#). Because 80 mA is 10% of the I<sub>BULK</sub> (800mA), the R<sub>TERM</sub> is calculated as (240 \* 10) or 2.4 k $\Omega$ .

### 9.2.1.2.4 Adapter Enable

The AD pin will be tied to the external USB power source to allow for an external source to power the system. AD\_EN is tied to the gate of Q1 (CSD75205W1015). This allows the bq51050B to sense when power is applied to the AD pin. The EN2 pin controls whether the wired source will be enabled or not. EN2 is tied to the system host to allow it to control the use of the USB power. If wired power is enabled and present, the AD pin will disable the BAT output and then enable Q1 through the AD\_EN pin. An external charger is required to take control of the battery charging.

### 9.2.1.2.5 Charge Indication and Power Capacitors

The CHG pin is open-drain. D<sub>1</sub> and R<sub>4</sub> are selected as a 2.1-V forward bias capable of 2 mA and a 100- $\Omega$  current-limiting resistor.

RECT is used to smooth the internal AC to DC conversion. Two 10- $\mu$ F capacitors and a 0.1- $\mu$ F capacitor are chosen. The rating is 25 V.

BAT capacitors are 1.0  $\mu$ F and 0.1  $\mu$ F.

**Typical Application (continued)**

**9.2.1.3 Application Curves**

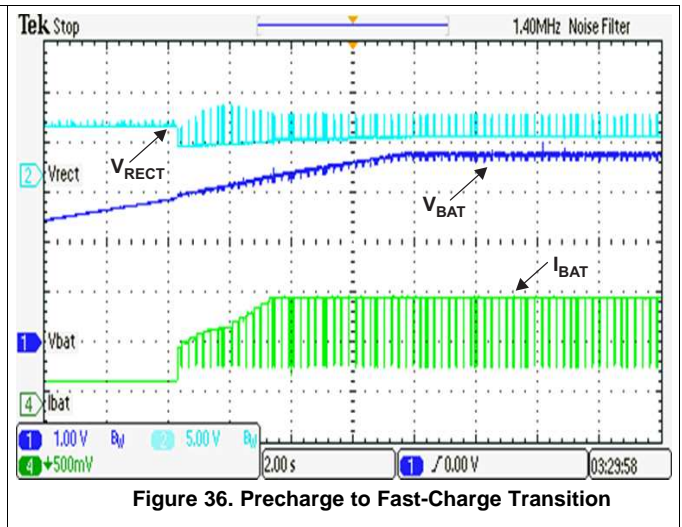
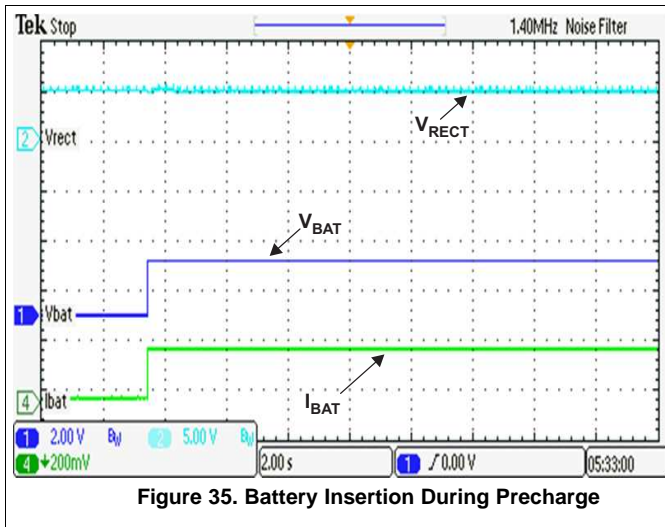





## 10 Power Supply Recommendations

The bq51050B requires a Qi-compatible transmitter as its power supply.

## 11 Layout

### 11.1 Layout Guidelines

- Keep the trace resistance as low as possible on AC1, AC2, and BAT.
- Detection and resonant capacitors need to be as close to the device as possible.
- COMM, CLAMP, and BOOT capacitors need to be placed as close to the device as possible.
- Via interconnect on PGND net is critical for appropriate signal integrity and proper thermal performance.
- High frequency bypass capacitors need to be placed close to RECT and OUT pins.
- ILIM and FOD resistors are important signal paths and the loops in those paths to PGND must be minimized.
- For the RHL package, connect the thermal pad to ground to help dissipate heat.

Signal and sensing traces are the most sensitive to noise; the sensing signal amplitudes are usually measured in mV, which is comparable to the noise amplitude. Make sure that these traces are not being interfered by the noisy and power traces. AC1, AC2, BOOT1, BOOT2, COMM1, and COMM2 are the main source of noise in the board. These traces should be shielded from other components in the board. It is usually preferred to have a ground copper area placed underneath these traces to provide additional shielding. Also, make sure they do not interfere with the signal and sensing traces. The PCB should have a ground plane (return) connected directly to the return of all components through vias (two vias per capacitor for power-stage capacitors, one via per capacitor for small-signal components).

For a 1-A fast charge current application, the current rating for each net is as follows:

- AC1 = AC2 = 1.2 A
- OUT = 1 A
- RECT = 100 mA (RMS)
- COMMx = 300 mA
- CLAMPx = 500 mA
- All others can be rated for 10 mA or less

### 11.2 Layout Example

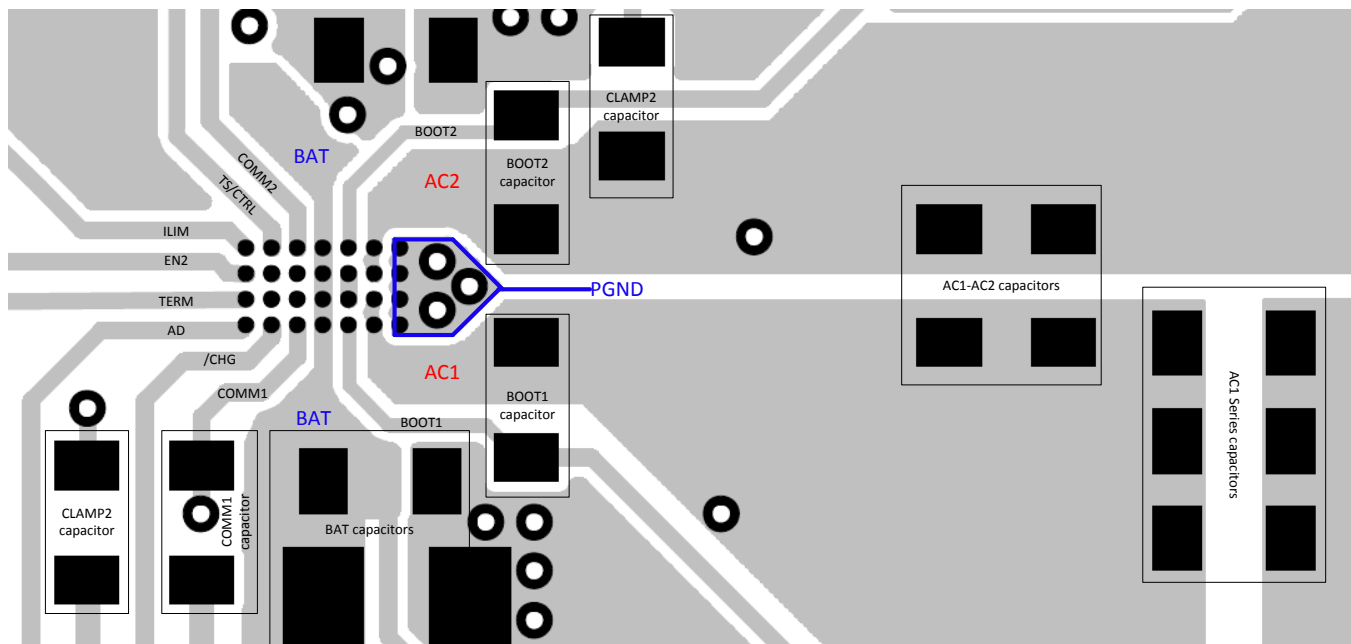

**Figure 38. bq5105x Layout Example**

## 12 器件和文档支持

### 12.1 文档支持

#### 12.1.1 相关文档

相关文档如下：

《具有自动启动功能的 bq2404x 1A 单输入单节锂离子和锂聚合物电池充电器》，[SLUS941](#)

### 12.2 相关链接

下面的表格列出了快速访问链接。类别包括技术文档、支持与社区资源、工具和软件，以及申请样片或购买产品的快速链接。

表 2. 相关链接

器件	产品文件夹	样片与购买	技术文档	工具和软件	支持和社区
bq51050B	<a href="#">请单击此处</a>	<a href="#">请单击此处</a>	<a href="#">请单击此处</a>	<a href="#">请单击此处</a>	<a href="#">请单击此处</a>
bq51051B	<a href="#">请单击此处</a>	<a href="#">请单击此处</a>	<a href="#">请单击此处</a>	<a href="#">请单击此处</a>	<a href="#">请单击此处</a>
bq51052B	<a href="#">请单击此处</a>	<a href="#">请单击此处</a>	<a href="#">请单击此处</a>	<a href="#">请单击此处</a>	<a href="#">请单击此处</a>

### 12.3 接收文档更新通知

要接收文档更新通知，请转至 [ti.com](http://ti.com) 上您的器件的产品文件夹。请在右上角单击 **通知我** 按钮进行注册，即可收到产品信息更改每周摘要（如有）。有关更改的详细信息，请查看任意已修订文档的修订历史记录。

### 12.4 社区资源

下列链接提供到 TI 社区资源的连接。链接的内容由各个分销商“按照原样”提供。这些内容并不构成 TI 技术规范，并且不一定反映 TI 的观点；请参阅 TI 的 [《使用条款》](#)。

**TI E2E™ 在线社区** *TI 的工程师对工程师 (E2E) 社区*。此社区的创建目的在于促进工程师之间的协作。在 [e2e.ti.com](http://e2e.ti.com) 中，您可以咨询问题、分享知识、拓展思路并与同行工程师一道帮助解决问题。

**设计支持** *TI 参考设计支持* 可帮助您快速查找有帮助的 E2E 论坛、设计支持工具以及技术支持的联系信息。

### 12.5 商标

E2E is a trademark of Texas Instruments.  
All other trademarks are the property of their respective owners.

### 12.6 静电放电警告



这些装置包含有限的内置 ESD 保护。存储或装卸时，应将导线一起截短或将装置放置于导电泡棉中，以防止 MOS 门极遭受静电损伤。

### 12.7 Glossary

[SLYZ022](#) — *TI Glossary*.

This glossary lists and explains terms, acronyms, and definitions.

## 13 机械、封装和可订购信息

以下页面包括机械、封装和可订购信息。这些信息是指定器件的最新可用数据。这些数据发生变化时，我们可能不会另行通知或修订此文档。如欲获取此产品说明书的浏览器版本，请参见左侧的导航栏。

**PACKAGING INFORMATION**

Orderable Device	Status (1)	Package Type	Package Drawing	Pins	Package Qty	Eco Plan (2)	Lead finish/ Ball material (6)	MSL Peak Temp (3)	Op Temp (°C)	Device Marking (4/5)	Samples
BQ51050BRHLR	ACTIVE	VQFN	RHL	20	3000	RoHS & Green	NIPDAU	Level-2-260C-1 YEAR	0 to 125	BQ51050B	<a href="#">Samples</a>
BQ51050BRHLT	ACTIVE	VQFN	RHL	20	250	RoHS & Green	NIPDAU	Level-2-260C-1 YEAR	0 to 125	BQ51050B	<a href="#">Samples</a>
BQ51050BYFPR	ACTIVE	DSBGA	YFP	28	3000	RoHS & Green	SNAGCU	Level-1-260C-UNLIM	0 to 125	BQ51050B	<a href="#">Samples</a>
BQ51050BYFPT	ACTIVE	DSBGA	YFP	28	250	RoHS & Green	SNAGCU	Level-1-260C-UNLIM	0 to 125	BQ51050B	<a href="#">Samples</a>
BQ51051BRHLR	ACTIVE	VQFN	RHL	20	3000	RoHS & Green	NIPDAU	Level-2-260C-1 YEAR	0 to 125	BQ51051B	<a href="#">Samples</a>
BQ51051BRHLT	ACTIVE	VQFN	RHL	20	250	RoHS & Green	NIPDAU	Level-2-260C-1 YEAR	0 to 125	BQ51051B	<a href="#">Samples</a>
BQ51051BYFPR	ACTIVE	DSBGA	YFP	28	3000	RoHS & Green	SNAGCU	Level-1-260C-UNLIM	0 to 125	BQ51051B	<a href="#">Samples</a>
BQ51051BYFPT	ACTIVE	DSBGA	YFP	28	250	RoHS & Green	SNAGCU	Level-1-260C-UNLIM	0 to 125	BQ51051B	<a href="#">Samples</a>
BQ51052BYFPR	ACTIVE	DSBGA	YFP	28	3000	RoHS & Green	SNAGCU	Level-1-260C-UNLIM	0 to 125	BQ51052B	<a href="#">Samples</a>
BQ51052BYFPT	ACTIVE	DSBGA	YFP	28	250	RoHS & Green	SNAGCU	Level-1-260C-UNLIM	0 to 125	BQ51052B	<a href="#">Samples</a>

(1) The marketing status values are defined as follows:

**ACTIVE:** Product device recommended for new designs.

**LIFEBUY:** TI has announced that the device will be discontinued, and a lifetime-buy period is in effect.

**NRND:** Not recommended for new designs. Device is in production to support existing customers, but TI does not recommend using this part in a new design.

**PREVIEW:** Device has been announced but is not in production. Samples may or may not be available.

**OBSOLETE:** TI has discontinued the production of the device.

(2) **RoHS:** TI defines "RoHS" to mean semiconductor products that are compliant with the current EU RoHS requirements for all 10 RoHS substances, including the requirement that RoHS substance do not exceed 0.1% by weight in homogeneous materials. Where designed to be soldered at high temperatures, "RoHS" products are suitable for use in specified lead-free processes. TI may reference these types of products as "Pb-Free".

**RoHS Exempt:** TI defines "RoHS Exempt" to mean products that contain lead but are compliant with EU RoHS pursuant to a specific EU RoHS exemption.

**Green:** TI defines "Green" to mean the content of Chlorine (Cl) and Bromine (Br) based flame retardants meet JS709B low halogen requirements of <=1000ppm threshold. Antimony trioxide based flame retardants must also meet the <=1000ppm threshold requirement.

(3) MSL, Peak Temp. - The Moisture Sensitivity Level rating according to the JEDEC industry standard classifications, and peak solder temperature.

(4) There may be additional marking, which relates to the logo, the lot trace code information, or the environmental category on the device.

<sup>(5)</sup> Multiple Device Markings will be inside parentheses. Only one Device Marking contained in parentheses and separated by a "~" will appear on a device. If a line is indented then it is a continuation of the previous line and the two combined represent the entire Device Marking for that device.

<sup>(6)</sup> Lead finish/Ball material - Orderable Devices may have multiple material finish options. Finish options are separated by a vertical ruled line. Lead finish/Ball material values may wrap to two lines if the finish value exceeds the maximum column width.

**Important Information and Disclaimer:**The information provided on this page represents TI's knowledge and belief as of the date that it is provided. TI bases its knowledge and belief on information provided by third parties, and makes no representation or warranty as to the accuracy of such information. Efforts are underway to better integrate information from third parties. TI has taken and continues to take reasonable steps to provide representative and accurate information but may not have conducted destructive testing or chemical analysis on incoming materials and chemicals. TI and TI suppliers consider certain information to be proprietary, and thus CAS numbers and other limited information may not be available for release.

In no event shall TI's liability arising out of such information exceed the total purchase price of the TI part(s) at issue in this document sold by TI to Customer on an annual basis.

**TAPE AND REEL INFORMATION**

**QUADRANT ASSIGNMENTS FOR PIN 1 ORIENTATION IN TAPE**

\*All dimensions are nominal

Device	Package Type	Package Drawing	Pins	SPQ	Reel Diameter (mm)	Reel Width W1 (mm)	A0 (mm)	B0 (mm)	K0 (mm)	P1 (mm)	W (mm)	Pin1 Quadrant
BQ51050BRHLR	VQFN	RHL	20	3000	330.0	12.4	3.71	4.71	1.1	8.0	12.0	Q1
BQ51050BRHLT	VQFN	RHL	20	250	180.0	12.4	3.71	4.71	1.1	8.0	12.0	Q1
BQ51050BYFPR	DSBGA	YFP	28	3000	180.0	8.4	2.0	3.13	0.6	4.0	8.0	Q1
BQ51050BYFPT	DSBGA	YFP	28	250	180.0	8.4	2.0	3.13	0.6	4.0	8.0	Q1
BQ51051BRHLR	VQFN	RHL	20	3000	330.0	12.4	3.71	4.71	1.1	8.0	12.0	Q1
BQ51051BRHLT	VQFN	RHL	20	250	180.0	12.4	3.71	4.71	1.1	8.0	12.0	Q1
BQ51051BYFPR	DSBGA	YFP	28	3000	180.0	8.4	2.0	3.13	0.6	4.0	8.0	Q1
BQ51051BYFPT	DSBGA	YFP	28	250	180.0	8.4	2.0	3.13	0.6	4.0	8.0	Q1
BQ51052BYFPR	DSBGA	YFP	28	3000	180.0	8.4	2.0	3.13	0.6	4.0	8.0	Q1
BQ51052BYFPT	DSBGA	YFP	28	250	180.0	8.4	2.0	3.13	0.6	4.0	8.0	Q1

**TAPE AND REEL BOX DIMENSIONS**

\*All dimensions are nominal

Device	Package Type	Package Drawing	Pins	SPQ	Length (mm)	Width (mm)	Height (mm)
BQ51050BRHLR	VQFN	RHL	20	3000	367.0	367.0	35.0
BQ51050BRHLT	VQFN	RHL	20	250	210.0	185.0	35.0
BQ51050BYFPR	DSBGA	YFP	28	3000	182.0	182.0	20.0
BQ51050BYFPT	DSBGA	YFP	28	250	182.0	182.0	20.0
BQ51051BRHLR	VQFN	RHL	20	3000	367.0	367.0	35.0
BQ51051BRHLT	VQFN	RHL	20	250	210.0	185.0	35.0
BQ51051BYFPR	DSBGA	YFP	28	3000	182.0	182.0	20.0
BQ51051BYFPT	DSBGA	YFP	28	250	182.0	182.0	20.0
BQ51052BYFPR	DSBGA	YFP	28	3000	182.0	182.0	20.0
BQ51052BYFPT	DSBGA	YFP	28	250	182.0	182.0	20.0

## GENERIC PACKAGE VIEW

**RHL 20**

**VQFN - 1 mm max height**

**3.5 x 4.5 mm, 0.5 mm pitch**

PLASTIC QUAD FLATPACK - NO LEAD

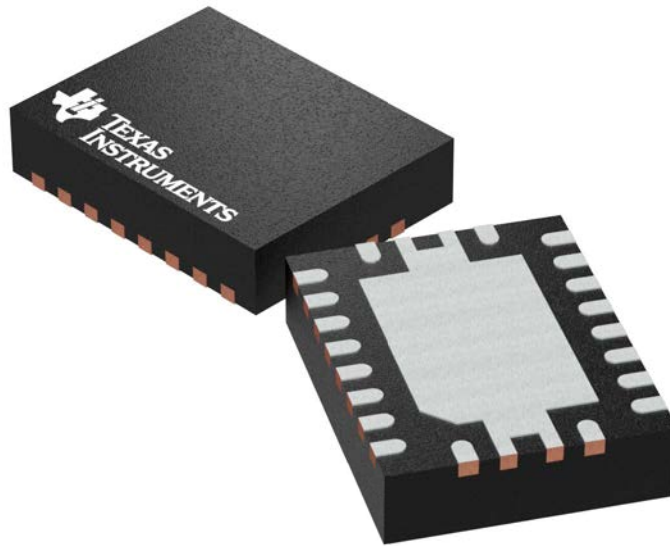

Images above are just a representation of the package family, actual package may vary.  
Refer to the product data sheet for package details.

4205346/L





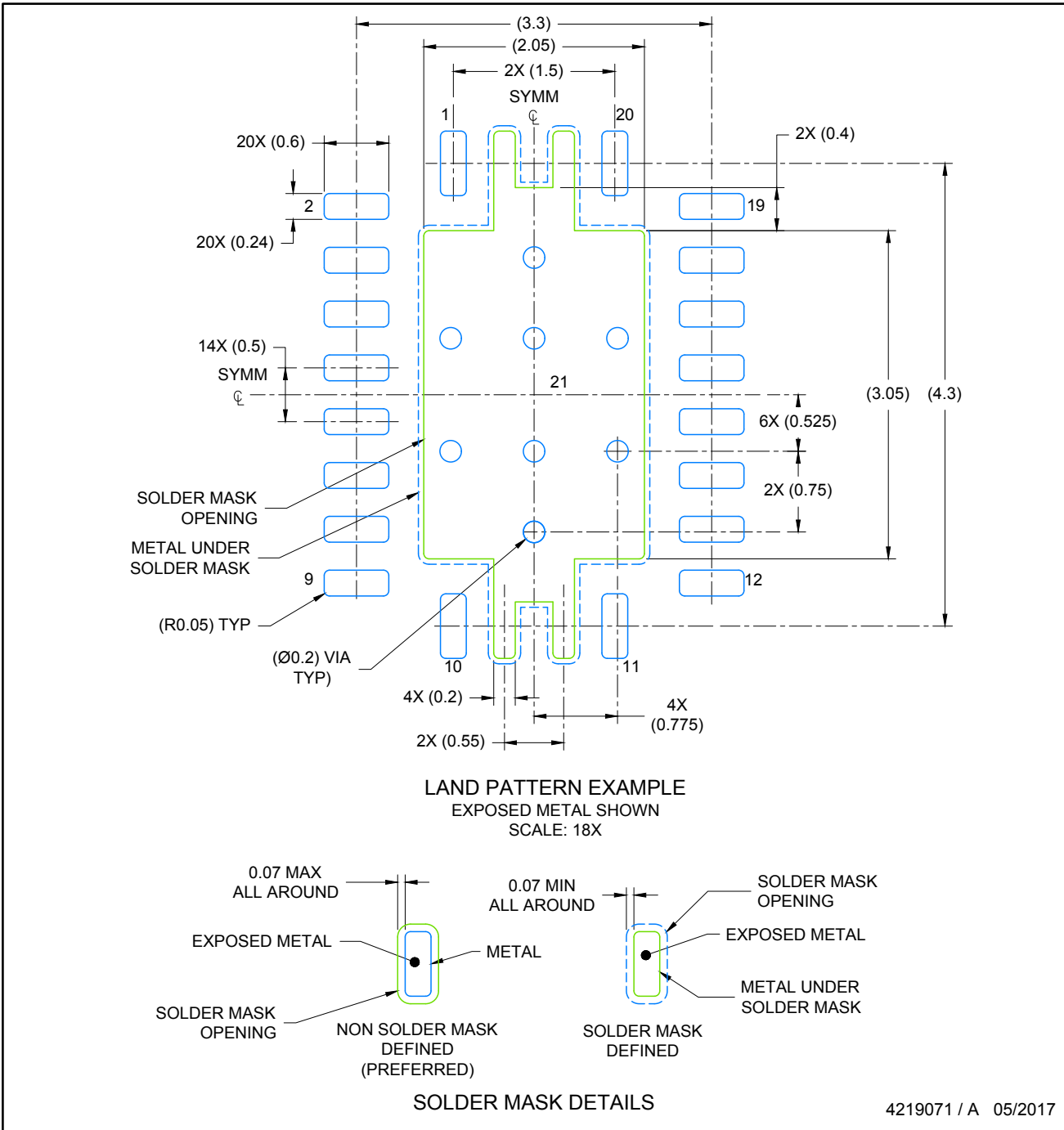

NOTES: (continued)

4. This package is designed to be soldered to a thermal pad on the board. For more information, see Texas Instruments literature number SLUA271 ([www.ti.com/lit/sluea271](http://www.ti.com/lit/sluea271)).
5. Solder mask tolerances between and around signal pads can vary based on board fabrication site.
6. Vias are optional depending on application, refer to device data sheet. If any vias are implemented, refer to their locations shown on this view. It is recommended that vias under paste be filled, plugged or tented.



NOTES: (continued)

7. Laser cutting apertures with trapezoidal walls and rounded corners may offer better paste release. IPC-7525 may have alternate design recommendations..

# MECHANICAL DATA

YFP (R-XBGA-N28)

DIE-SIZE BALL GRID ARRAY

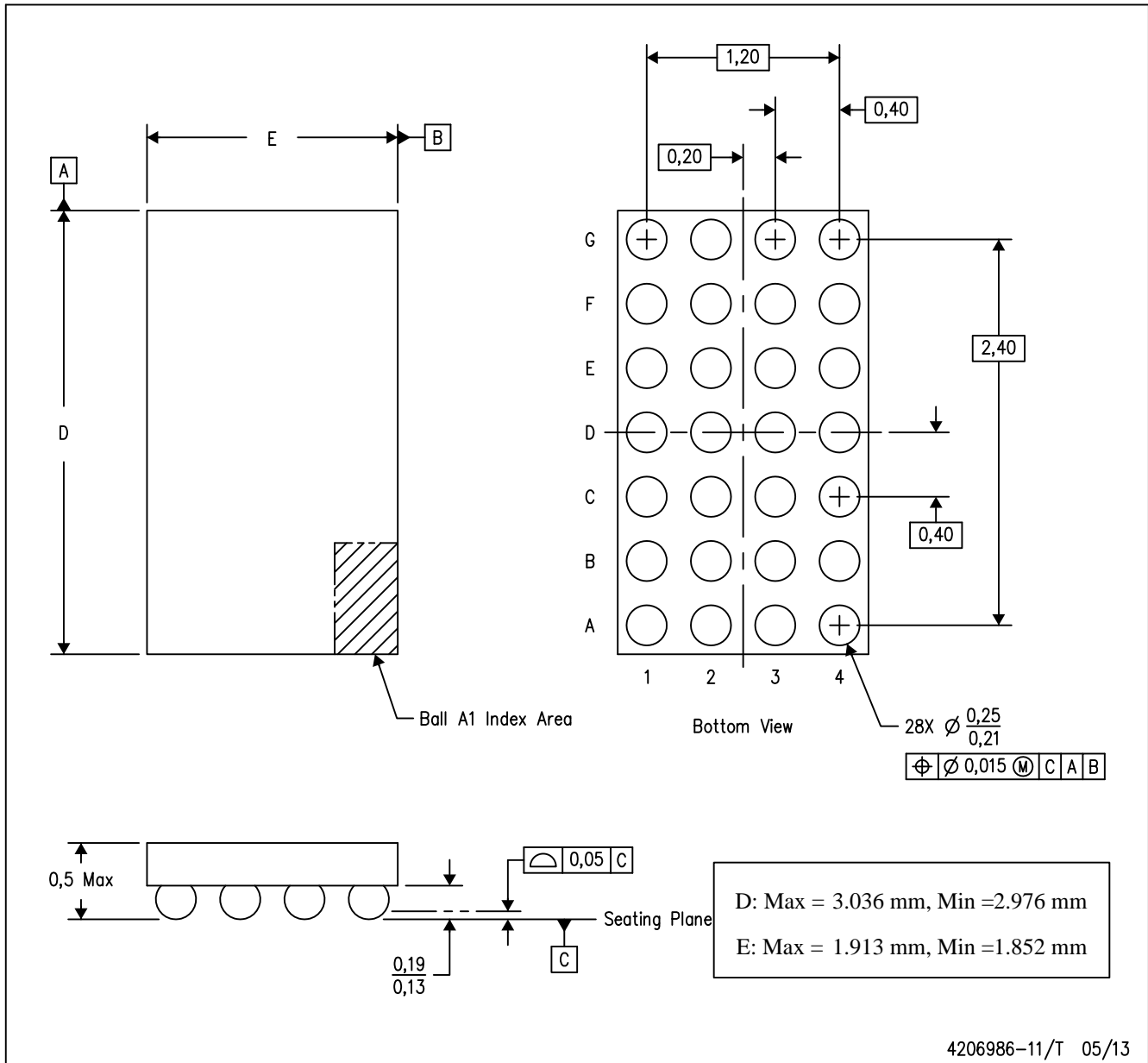

- NOTES:
- A. All linear dimensions are in millimeters. Dimensioning and tolerancing per ASME Y14.5M-1994.
  - B. This drawing is subject to change without notice.
  - C. NanoFree™ package configuration.

NanoFree is a trademark of Texas Instruments

## 重要声明和免责声明

TI 均以“原样”提供技术性及其可靠性数据（包括数据表）、设计资源（包括参考设计）、应用或其他设计建议、网络工具、安全信息和其他资源，不保证其中不含任何瑕疵，且不做任何明示或暗示的担保，包括但不限于对适销性、适合某特定用途或不侵犯任何第三方知识产权的暗示担保。

所述资源可供专业开发人员应用TI 产品进行设计使用。您将对以下行为独自承担全部责任：(1) 针对您的应用选择合适的TI 产品；(2) 设计、验证并测试您的应用；(3) 确保您的应用满足相应标准以及任何其他安全、安保或其他要求。所述资源如有变更，恕不另行通知。TI 对您使用所述资源的授权仅限于开发资源所涉及TI 产品的相关应用。除此之外不得复制或展示所述资源，也不提供其它TI 或任何第三方的知识产权授权许可。如因使用所述资源而产生任何索赔、赔偿、成本、损失及债务等，TI 对此概不负责，并且您须赔偿由此对TI 及其代表造成的损害。

TI 所提供产品均受TI 的销售条款 (<http://www.ti.com.cn/zh-cn/legal/termsofsale.html>) 以及ti.com.cn上或随附TI产品提供的其他可适用条款的约束。TI提供所述资源并不扩展或以其他方式更改TI 针对TI 产品所发布的可适用的担保范围或担保免责声明。

邮寄地址：上海市浦东新区世纪大道 1568 号中建大厦 32 楼，邮政编码：200122

Copyright © 2020 德州仪器半导体技术（上海）有限公司