

CSD18510Q5B N 通道 NexFET™ 功率金属氧化物半导体场效应晶体管 (MOSFET)

1 特性

- 低 $R_{DS(ON)}$
- 低热阻
- 雪崩额定值
- 逻辑电平
- 无铅引脚镀层
- 符合 RoHS 环保标准
- 无卤素
- 小外形尺寸无引线 (SON) 5mm x 6mm 塑料封装

2 应用范围

- 直流 - 直流转换
- 次级侧同步整流器
- 电机控制

3 说明

这款采用 5mm x 6mm SON 封装的 40V、0.79mΩ、NexFET™ 功率 MOSFET 的设计旨在追求以最大限度降低功率转换应用中的功率损耗。

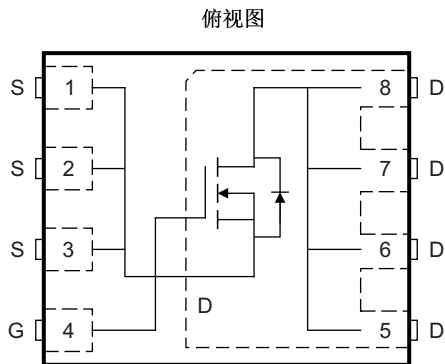

产品概要

$T_A = 25^\circ\text{C}$		典型值		单位
V_{DS}	漏源电压	40		V
Q_g	栅极电荷总量 (10V)	118		nC
Q_{gd}	栅极电荷 (栅极到漏极)	21		nC
$R_{DS(on)}$	漏源导通电阻	$V_{GS} = 4.5\text{V}$	1.2	mΩ
		$V_{GS} = 10\text{V}$	0.79	
$V_{GS(th)}$	阈值电压	1.7		V

器件信息(1)

器件	数量	包装介质	封装	运输
CSD18510Q5B	2500	13 英寸卷带	5.00mm x 6.00mm SON 塑料封装	卷带封装
CSD18510Q5BT	250	7 英寸卷带		

(1) 要了解所有可用封装, 请见数据表末尾的可订购产品附录。

绝对最大额定值

$T_A = 25^\circ\text{C}$		值	单位
V_{DS}	漏源电压	40	V
V_{GS}	栅源电压	± 20	V
I_D	持续漏极电流 (受封装限制)	100	A
	持续漏极电流 (受芯片限制), $T_C = 25^\circ\text{C}$ 时测得	300	
	持续漏极电流 ⁽¹⁾	42	
I_{DM}	脉冲漏极电流, $T_A = 25^\circ\text{C}$ 时测得 ⁽²⁾	400	A
P_D	功率耗散 ⁽¹⁾	3.1	W
	功率耗散, $T_C = 25^\circ\text{C}$	156	
T_J, T_{stg}	工作结温, 储存温度	-55 至 150	$^\circ\text{C}$
E_{AS}	雪崩能量, 单一脉冲 $I_D = 81, L = 0.1\text{mH}, R_G = 25\Omega$	328	mJ

(1) $R_{\theta JA} = 40^\circ\text{C}/\text{W}$, 这是在一块厚度为 0.06 英寸环氧树脂 (FR4) 印刷电路板 (PCB) 上的 1 英寸², 2 盎司铜焊盘上测得的典型值。

(2) 最大 $R_{\theta JC} = 0.8^\circ\text{C}/\text{W}$, 脉冲持续时间 $\leq 100\mu\text{s}$, 占空比 $\leq 1\%$ 。



$R_{DS(on)}$ 与 V_{GS} 间的关系

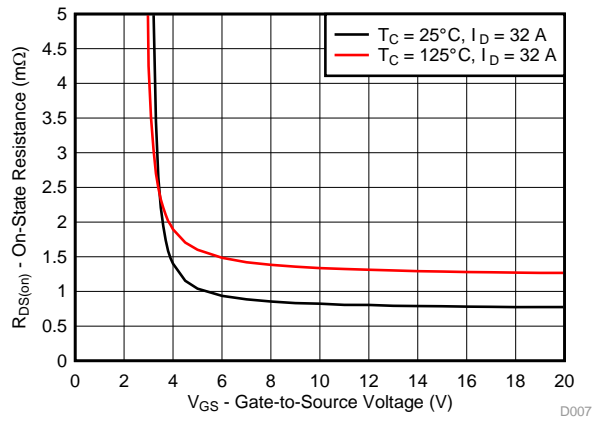

栅极电荷

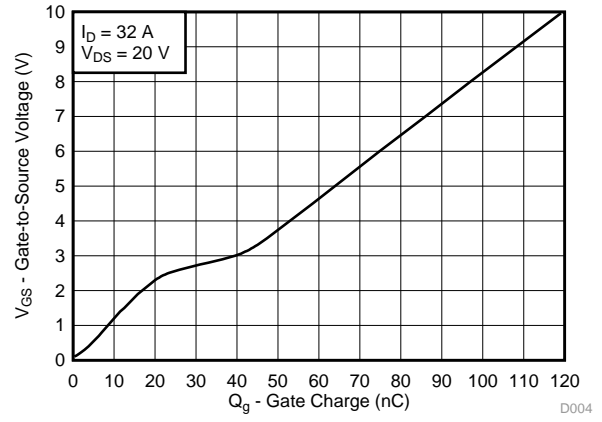

目录

1	特性	1	6.1	接收文档更新通知	8
2	应用范围	1	6.2	社区资源	8
3	说明	1	6.3	商标	8
4	修订历史记录	3	6.4	静电放电警告	8
5	Specifications	4	6.5	Glossary	8
	5.1 Electrical Characteristics	4	7	机械、封装和可订购信息	9
	5.2 Thermal Information	4	7.1	Q5B 封装尺寸	9
	5.3 Typical MOSFET Characteristics	5	7.2	建议 PCB 布局	10
6	器件和文档支持	8	7.3	建议模板布局	10
			7.4	Q5B 卷带信息	11

4 修订历史记录

日期	修订版本	注释
2017 年 3 月	*	最初发布。

5 Specifications

5.1 Electrical Characteristics

 $T_A = 25^\circ\text{C}$ (unless otherwise stated)

PARAMETER		TEST CONDITIONS	MIN	TYP	MAX	UNIT
STATIC CHARACTERISTICS						
V_{DSS}	Drain-to-source voltage	$V_{GS} = 0\text{ V}, I_D = 250\ \mu\text{A}$	40			V
I_{DSS}	Drain-to-source leakage current	$V_{GS} = 0\text{ V}, V_{DS} = 32\text{ V}$			1	μA
I_{GSS}	Gate-to-source leakage current	$V_{DS} = 0\text{ V}, V_{GS} = 20\text{ V}$			100	nA
$V_{GS(th)}$	Gate-to-source threshold voltage	$V_{DS} = V_{GS}, I_D = 250\ \mu\text{A}$	1.2	1.7	2.3	V
$R_{DS(on)}$	Drain-to-source on resistance	$V_{GS} = 4.5\text{ V}, I_D = 32\text{ A}$		1.2	1.6	m Ω
		$V_{GS} = 10\text{ V}, I_D = 32\text{ A}$		0.79	0.96	
g_{fs}	Transconductance	$V_{DS} = 4\text{ V}, I_D = 32\text{ A}$		147		S
DYNAMIC CHARACTERISTICS						
C_{iss}	Input capacitance	$V_{GS} = 0\text{ V}, V_{DS} = 20\text{ V}, f = 1\text{ MHz}$		8770	11400	pF
C_{oss}	Output capacitance			832	1080	pF
C_{rss}	Reverse transfer capacitance			424	551	pF
R_G	Series gate resistance			0.9	1.8	Ω
Q_g	Gate charge total (4.5 V)	$V_{DS} = 20\text{ V}, I_D = 32\text{ A}$		58	75	nC
Q_g	Gate charge total (10 V)			118	153	nC
Q_{gd}	Gate charge gate-to-drain			21		nC
Q_{gs}	Gate charge gate-to-source			28		nC
$Q_{g(th)}$	Gate charge at V_{th}			15		nC
Q_{oss}	Output charge		$V_{DS} = 20\text{ V}, V_{GS} = 0\text{ V}$		35	
$t_{d(on)}$	Turnon delay time	$V_{DS} = 20\text{ V}, V_{GS} = 10\text{ V}, I_{DS} = 32\text{ A}, R_G = 0\ \Omega$		8		ns
t_r	Rise time			17		ns
$t_{d(off)}$	Turnoff delay time			44		ns
t_f	Fall time			15		ns
DIODE CHARACTERISTICS						
V_{SD}	Diode forward voltage	$I_{SD} = 32\text{ A}, V_{GS} = 0\text{ V}$		0.8	1.0	V
Q_{rr}	Reverse recovery charge	$V_{DS} = 20\text{ V}, I_F = 32\text{ A}, di/dt = 300\text{ A}/\mu\text{s}$		31		nC
t_{rr}	Reverse recovery time			19		ns

5.2 Thermal Information

 $T_A = 25^\circ\text{C}$ (unless otherwise stated)

THERMAL METRIC		MIN	TYP	MAX	UNIT
$R_{\theta JC}$	Junction-to-case thermal resistance ⁽¹⁾			0.8	$^\circ\text{C}/\text{W}$
$R_{\theta JA}$	Junction-to-ambient thermal resistance ⁽¹⁾⁽²⁾			50	$^\circ\text{C}/\text{W}$

- (1) $R_{\theta JC}$ is determined with the device mounted on a 1-in² (6.45-cm²), 2-oz (0.071-mm) thick Cu pad on a 1.5-in × 1.5-in (3.81-cm × 3.81-cm), 0.06-in (1.52-mm) thick FR4 PCB. $R_{\theta JC}$ is specified by design, whereas $R_{\theta JA}$ is determined by the user's board design.
- (2) Device mounted on FR4 material with 1-in² (6.45-cm²), 2-oz (0.071-mm) thick Cu.

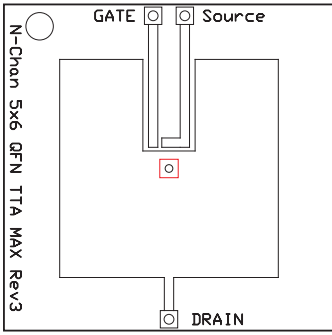

M0137-01

Max $R_{\theta JA} = 50^{\circ}\text{C/W}$
when mounted on 1 in²
(6.45 cm²) of
2-oz (0.071-mm) thick
Cu.

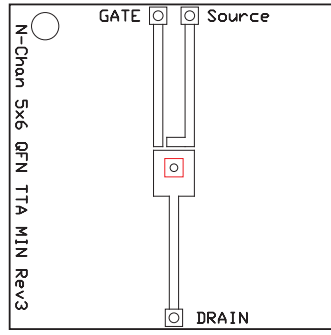

M0137-02

Max $R_{\theta JA} = 125^{\circ}\text{C/W}$
when mounted on a
minimum pad area of
2-oz (0.071-mm) thick
Cu.

5.3 Typical MOSFET Characteristics

$T_A = 25^{\circ}\text{C}$ (unless otherwise stated)

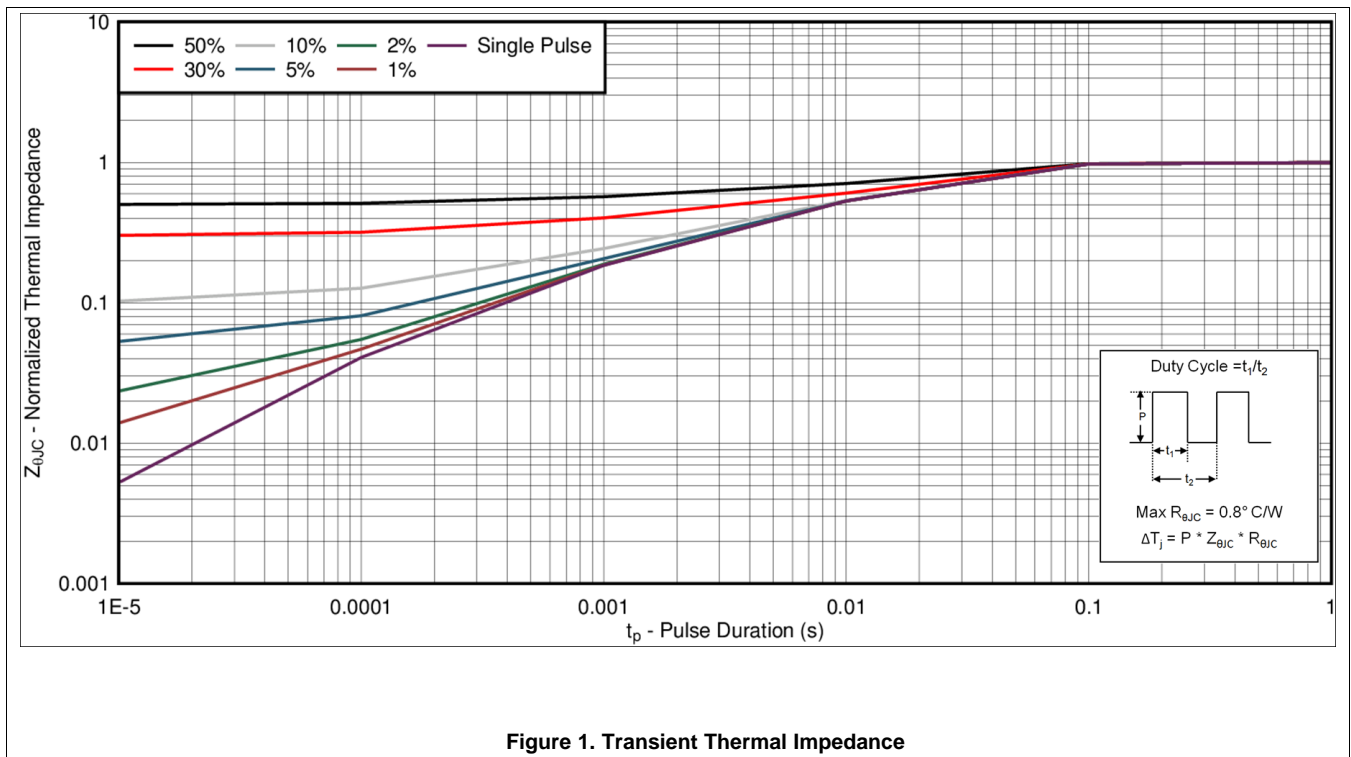
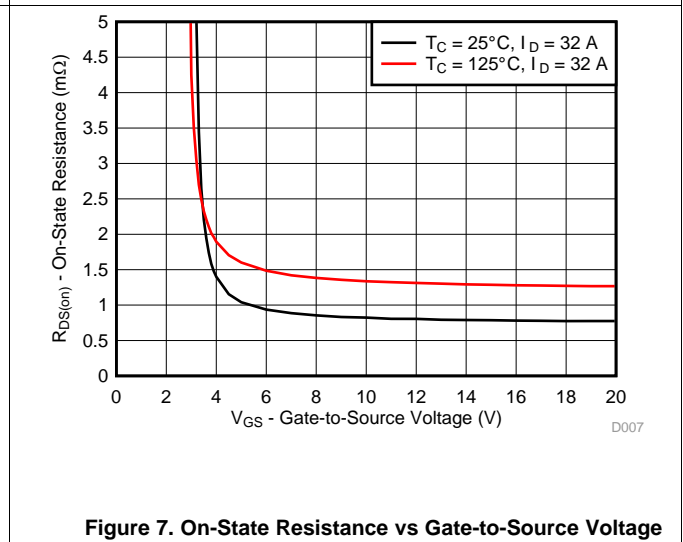
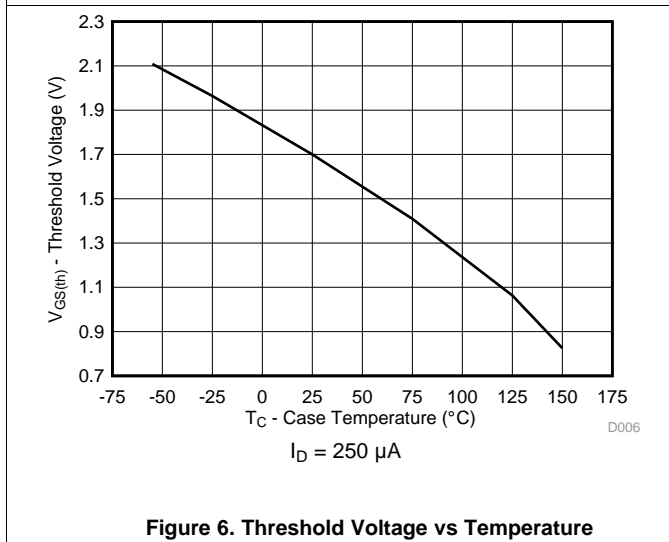
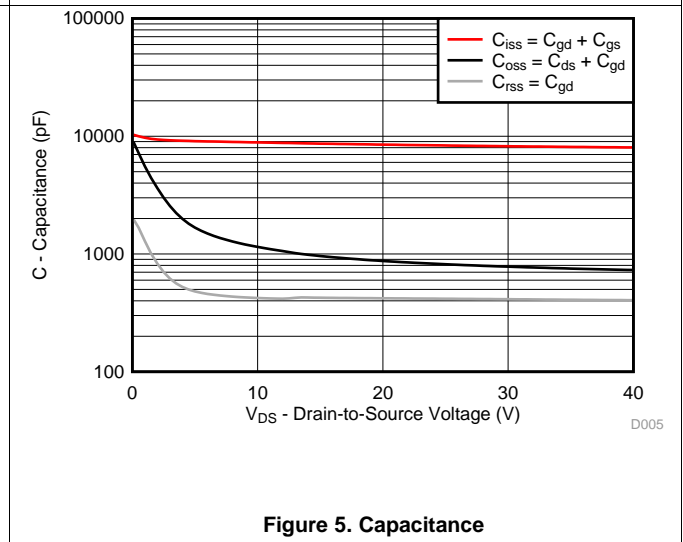
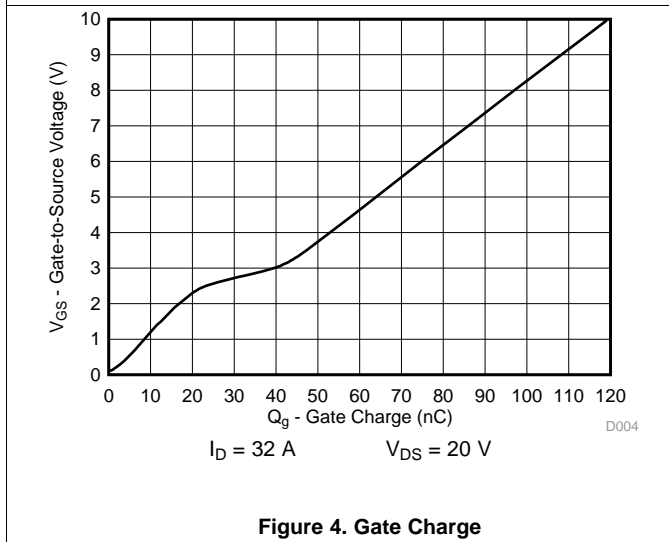
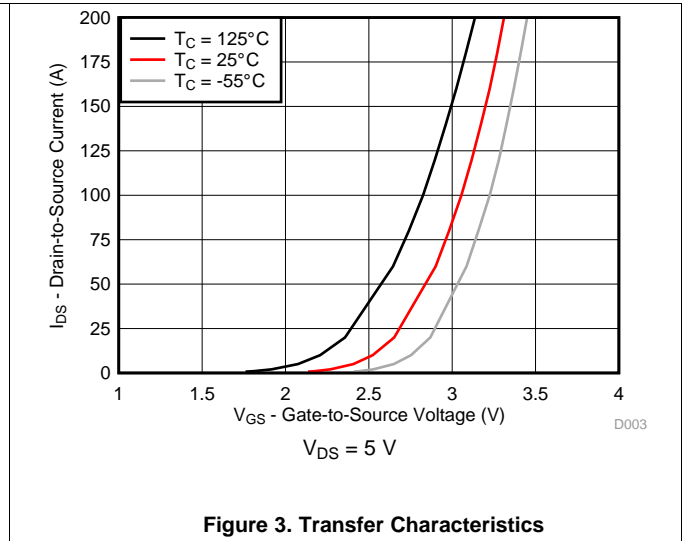
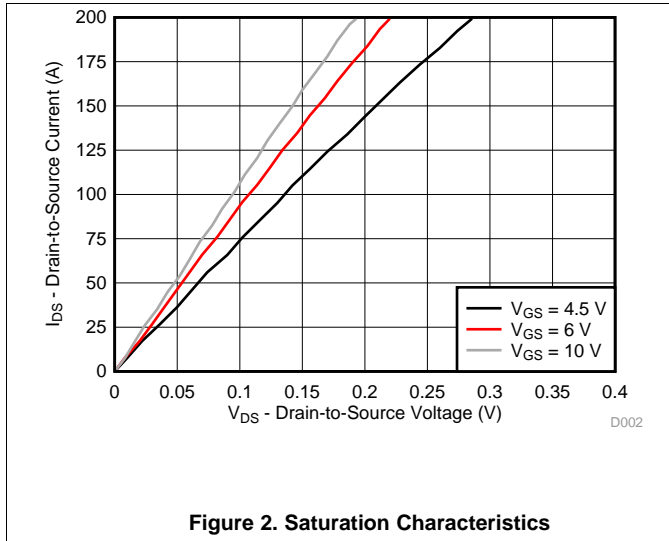

Figure 1. Transient Thermal Impedance

Typical MOSFET Characteristics (continued)

$T_A = 25^\circ\text{C}$ (unless otherwise stated)



Typical MOSFET Characteristics (continued)

T_A = 25°C (unless otherwise stated)

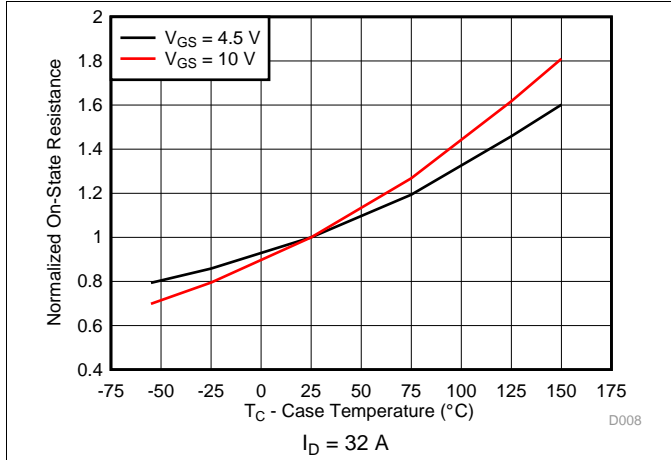

Figure 8. Normalized On-State Resistance vs Temperature

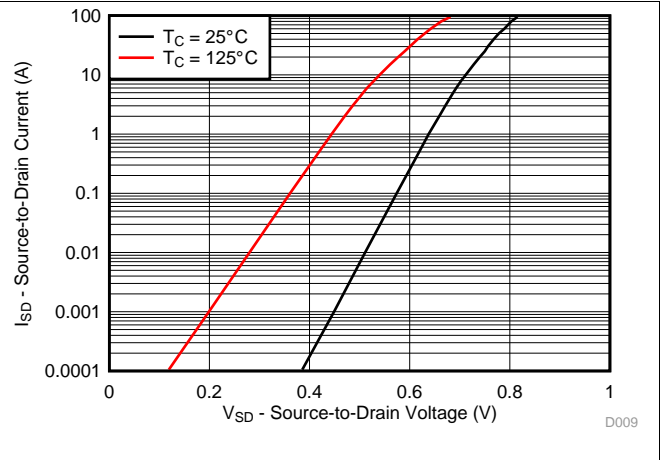

Figure 9. Typical Diode Forward Voltage

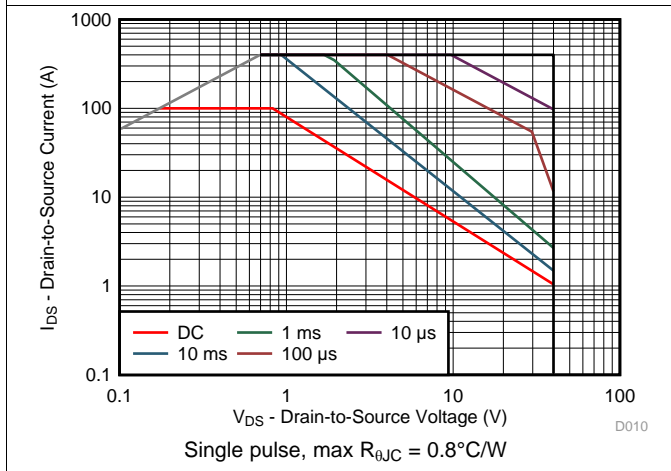

Figure 10. Maximum Safe Operating Area

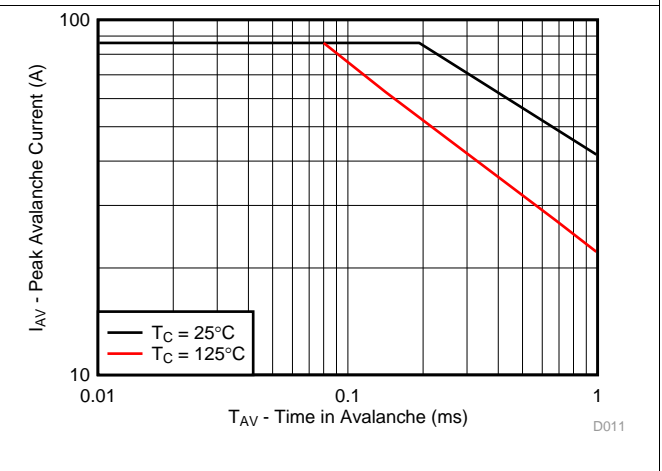

Figure 11. Single Pulse Unclamped Inductive Switching

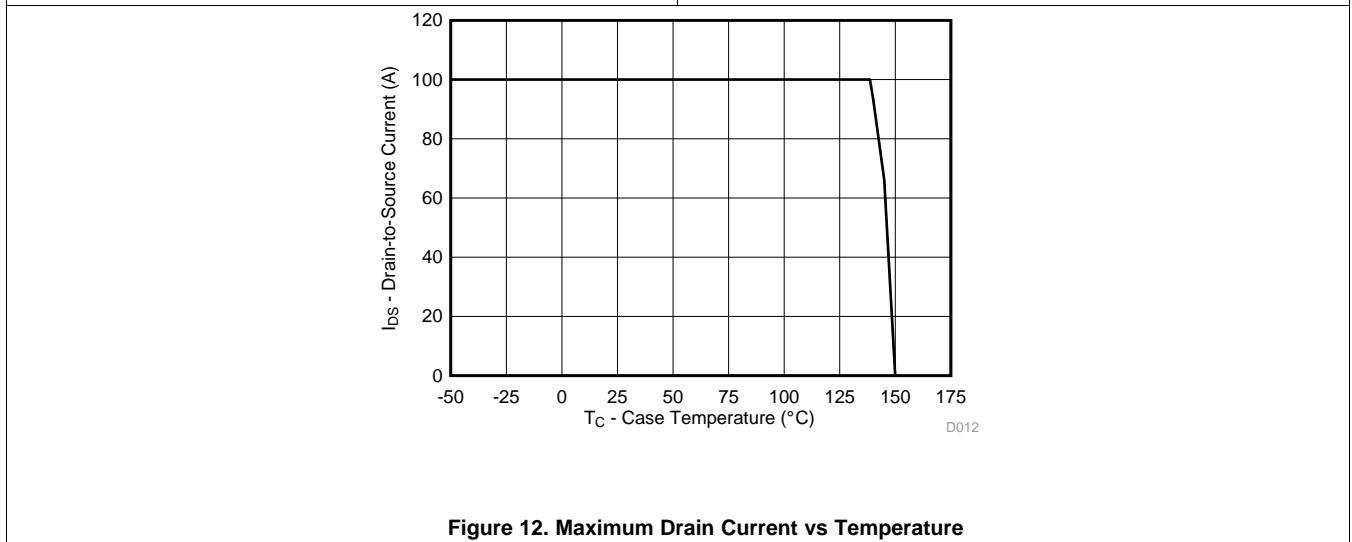

Figure 12. Maximum Drain Current vs Temperature

6 器件和文档支持

6.1 接收文档更新通知

如需接收文档更新通知，请访问 www.ti.com.cn 网站上的器件产品文件夹。点击右上角的提醒我 (Alert me) 注册后，即可每周定期收到已更改的产品信息。有关更改的详细信息，请查阅已修订文档中包含的修订历史记录。

6.2 社区资源

The following links connect to TI community resources. Linked contents are provided "AS IS" by the respective contributors. They do not constitute TI specifications and do not necessarily reflect TI's views; see TI's [Terms of Use](#).

TI E2E™ Online Community *TI's Engineer-to-Engineer (E2E) Community*. Created to foster collaboration among engineers. At e2e.ti.com, you can ask questions, share knowledge, explore ideas and help solve problems with fellow engineers.

Design Support *TI's Design Support* Quickly find helpful E2E forums along with design support tools and contact information for technical support.

6.3 商标

NexFET, E2E are trademarks of Texas Instruments.
All other trademarks are the property of their respective owners.

6.4 静电放电警告



这些装置包含有限的内置 ESD 保护。存储或装卸时，应将导线一起截短或将装置放置于导电泡棉中，以防止 MOS 门极遭受静电损伤。

6.5 Glossary

[SLYZ022](#) — *TI Glossary*.

This glossary lists and explains terms, acronyms, and definitions.

7 机械、封装和可订购信息

以下页中包括机械、封装和可订购信息。这些信息是针对指定器件可提供的最新数据。这些数据会在无通知且不对本文档进行修订的情况下发生改变。要获得这份数据表的浏览器版本，请查阅左侧的导航栏。

7.1 Q5B 封装尺寸

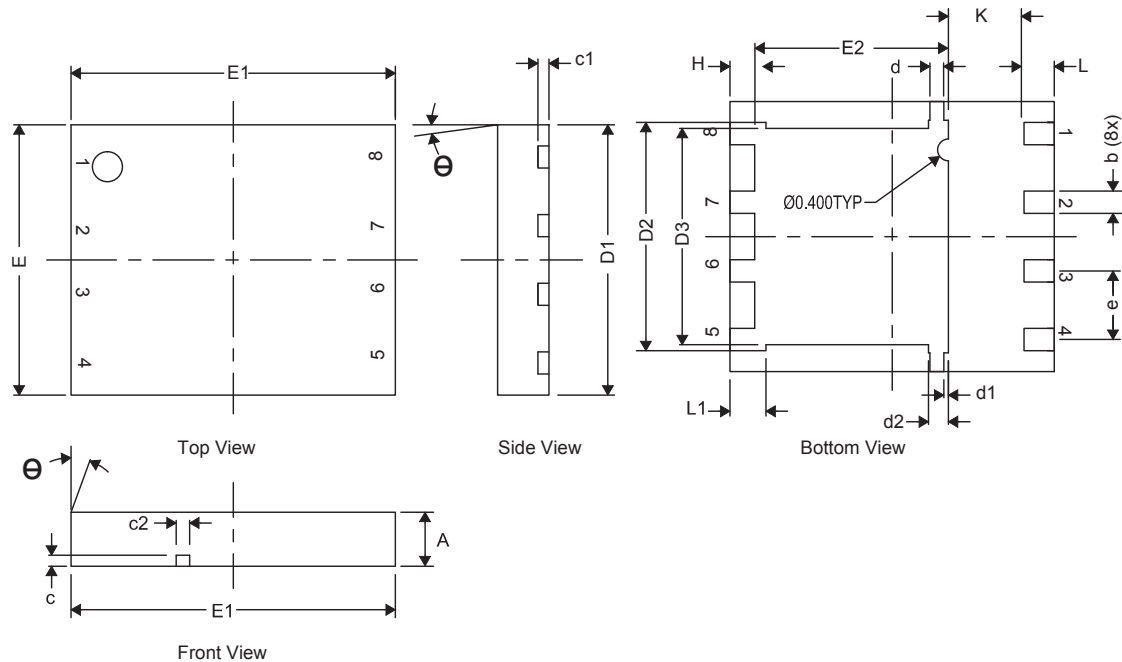

DIM	毫米		
	最小值	标称值	最大值
A	0.80	1.00	1.05
b	0.36	0.41	0.46
c	0.15	0.20	0.25
c1	0.15	0.20	0.25
c2	0.20	0.25	0.30
D1	4.90	5.00	5.10
D2	4.12	4.22	4.32
D3	3.90	4.00	4.10
d	0.20	0.25	0.30
d1	0.085 典型值		
d2	0.319	0.369	0.419
E	4.90	5.00	5.10
E1	5.90	6.00	6.10
E2	3.48	3.58	3.68
e	1.27 典型值		
H	0.36	0.46	0.56
L	0.46	0.56	0.66
L1	0.57	0.67	0.77
θ	0°	—	—
K	1.40 典型值		

7.2 建议 PCB 布局

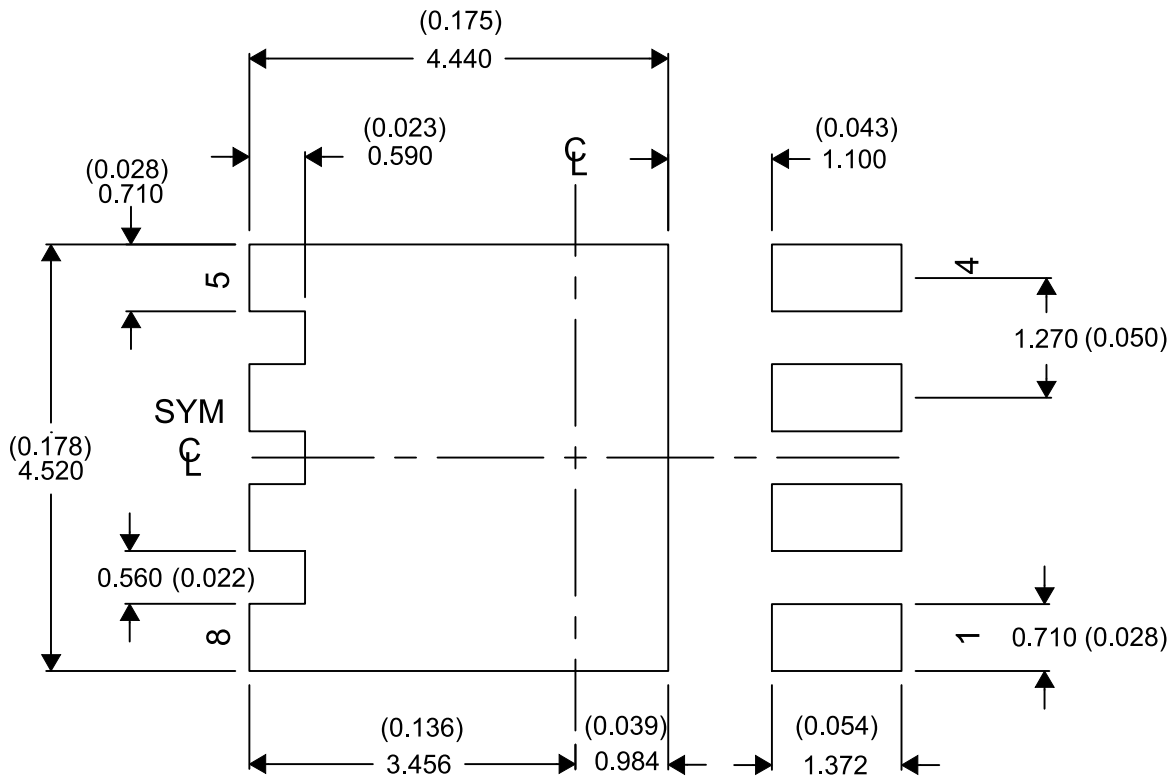

有关针对 PCB 设计的建议电路布局布线，请参见《[通过 PCB 布局布线技巧来减少振铃](#)》（文献编号：SLPA005）。

7.3 建议模板布局

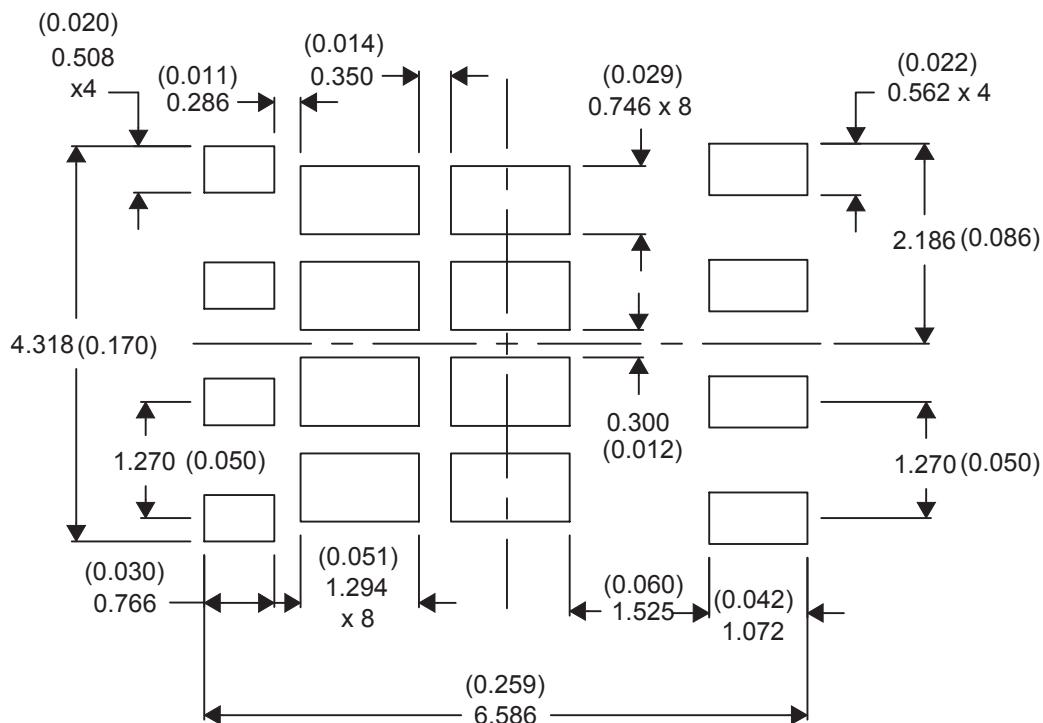

7.4 Q5B 卷带信息

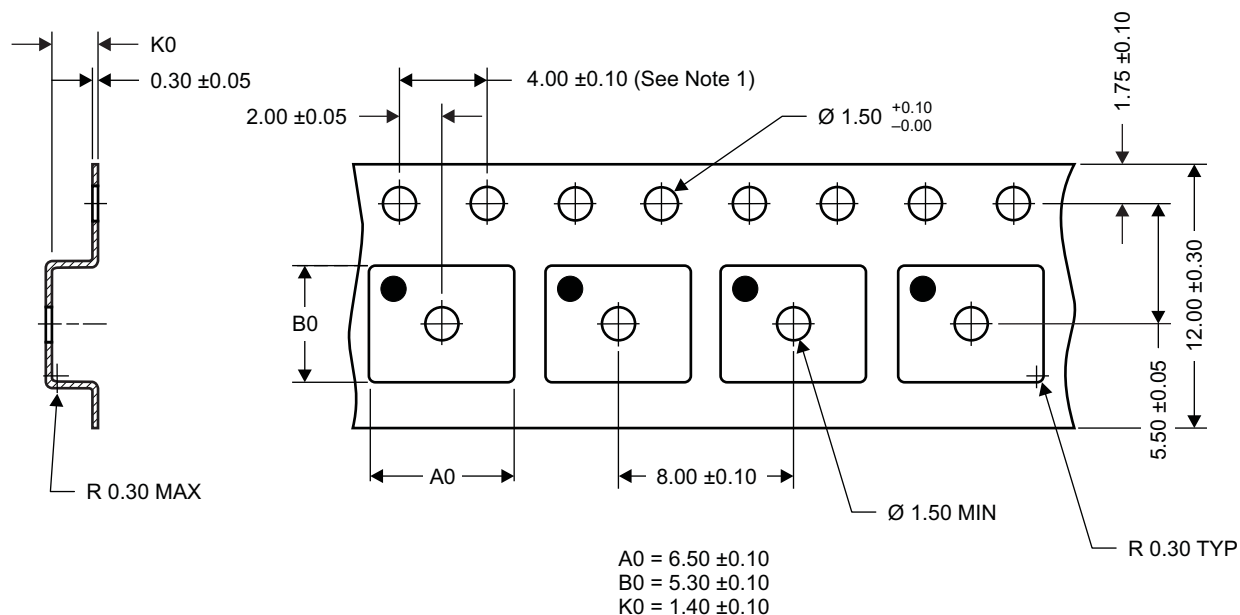

M0138-01

注释:

1. 10 链齿孔距累积容差 ± 0.2 。
2. 每 100mm 长度的翘曲不能超过 1mm，在 250mm 长度上不累积。
3. 材料：黑色抗静电聚苯乙烯。
4. 全部尺寸单位为 mm（除非另外注明）
5. 高于孔眼底部 0.3mm 的平面上测量得到 A0 和 B0 值。

PACKAGING INFORMATION

Orderable Device	Status (1)	Package Type	Package Drawing	Pins	Package Qty	Eco Plan (2)	Lead finish/ Ball material (6)	MSL Peak Temp (3)	Op Temp (°C)	Device Marking (4/5)	Samples
CSD18510Q5B	ACTIVE	VSON-CLIP	DNK	8	2500	RoHS-Exempt & Green	NIPDAU	Level-1-260C-UNLIM	-55 to 150	CSD18510	Samples
CSD18510Q5BT	ACTIVE	VSON-CLIP	DNK	8	250	RoHS-Exempt & Green	NIPDAU	Level-1-260C-UNLIM	-55 to 150	CSD18510	Samples

(1) The marketing status values are defined as follows:

ACTIVE: Product device recommended for new designs.

LIFEBUY: TI has announced that the device will be discontinued, and a lifetime-buy period is in effect.

NRND: Not recommended for new designs. Device is in production to support existing customers, but TI does not recommend using this part in a new design.

PREVIEW: Device has been announced but is not in production. Samples may or may not be available.

OBSOLETE: TI has discontinued the production of the device.

(2) **RoHS:** TI defines "RoHS" to mean semiconductor products that are compliant with the current EU RoHS requirements for all 10 RoHS substances, including the requirement that RoHS substance do not exceed 0.1% by weight in homogeneous materials. Where designed to be soldered at high temperatures, "RoHS" products are suitable for use in specified lead-free processes. TI may reference these types of products as "Pb-Free".

RoHS Exempt: TI defines "RoHS Exempt" to mean products that contain lead but are compliant with EU RoHS pursuant to a specific EU RoHS exemption.

Green: TI defines "Green" to mean the content of Chlorine (Cl) and Bromine (Br) based flame retardants meet JS709B low halogen requirements of <=1000ppm threshold. Antimony trioxide based flame retardants must also meet the <=1000ppm threshold requirement.

(3) MSL, Peak Temp. - The Moisture Sensitivity Level rating according to the JEDEC industry standard classifications, and peak solder temperature.

(4) There may be additional marking, which relates to the logo, the lot trace code information, or the environmental category on the device.

(5) Multiple Device Markings will be inside parentheses. Only one Device Marking contained in parentheses and separated by a "~" will appear on a device. If a line is indented then it is a continuation of the previous line and the two combined represent the entire Device Marking for that device.

(6) Lead finish/Ball material - Orderable Devices may have multiple material finish options. Finish options are separated by a vertical ruled line. Lead finish/Ball material values may wrap to two lines if the finish value exceeds the maximum column width.

Important Information and Disclaimer:The information provided on this page represents TI's knowledge and belief as of the date that it is provided. TI bases its knowledge and belief on information provided by third parties, and makes no representation or warranty as to the accuracy of such information. Efforts are underway to better integrate information from third parties. TI has taken and continues to take reasonable steps to provide representative and accurate information but may not have conducted destructive testing or chemical analysis on incoming materials and chemicals. TI and TI suppliers consider certain information to be proprietary, and thus CAS numbers and other limited information may not be available for release.

In no event shall TI's liability arising out of such information exceed the total purchase price of the TI part(s) at issue in this document sold by TI to Customer on an annual basis.

重要声明和免责声明

TI 均以“原样”提供技术性及其可靠性数据（包括数据表）、设计资源（包括参考设计）、应用或其他设计建议、网络工具、安全信息和其他资源，不保证其中不含任何瑕疵，且不做任何明示或暗示的担保，包括但不限于对适销性、适合某特定用途或不侵犯任何第三方知识产权的暗示担保。

所述资源可供专业开发人员应用TI 产品进行设计使用。您将对以下行为独自承担全部责任：(1) 针对您的应用选择合适的TI 产品；(2) 设计、验证并测试您的应用；(3) 确保您的应用满足相应标准以及任何其他安全、安保或其他要求。所述资源如有变更，恕不另行通知。TI 对您使用所述资源的授权仅限于开发资源所涉及TI 产品的相关应用。除此之外不得复制或展示所述资源，也不提供其它TI 或任何第三方的知识产权授权许可。如因使用所述资源而产生任何索赔、赔偿、成本、损失及债务等，TI 对此概不负责，并且您须赔偿由此对TI 及其代表造成的损害。

TI 所提供产品均受TI 的销售条款 (<http://www.ti.com.cn/zh-cn/legal/termsofsale.html>) 以及ti.com.cn上或随附TI产品提供的其他可适用条款的约束。TI提供所述资源并不扩展或以其他方式更改TI 针对TI 产品所发布的可适用的担保范围或担保免责声明。

邮寄地址：上海市浦东新区世纪大道 1568 号中建大厦 32 楼，邮政编码：200122

Copyright © 2020 德州仪器半导体技术（上海）有限公司