

# 双路 30V N 通道 NextFET™ 功率金属氧化物半导体场效应晶体管 (MOSFET)

## 特性

- 共源连接
- 超低漏极到漏极导通电阻
- 节省空间的小外形尺寸无引线 (SON) 3.3mm x 3.3mm 塑料封装
- 针对 5V 栅极驱动进行了优化
- 低热阻
- 雪崩级
- 无铅端子镀层
- 符合 RoHS 标准
- 无卤素

## 应用范围

- 针对笔记本个人电脑 (PC) 和平板电脑的适配器 / USB 输入保护

## 说明

CSD87312Q3E 是一款设计用于适配器 / USB 输入保护的 30V 共源、双路 N 通道器件。此类 SON 3.3mm x 3.3mm 器件有低漏极到漏极导通电阻，这大大减少了损耗并且为空间受限的多节电池充电类应用提供低组件数量。

## 产品概述

T <sub>A</sub> =25°C		典型值	单位
V <sub>DS</sub>	漏源电压	30	V
Q <sub>g</sub>	栅极电荷总量 (4.5V)	6.3	nC
Q <sub>gd</sub>	栅漏栅极电荷	0.7	nC
R <sub>DD</sub> (导通)	漏极到漏极导通电阻 (Q1+Q2)	V <sub>GS</sub> =4.5V	31 mΩ
		V <sub>GS</sub> =8V	27 mΩ
V <sub>GS(th)</sub>	阈值电压	1.0	V

## 订购信息

器件	封装	介质	数量	出货
CSD87312Q3E	小外形尺寸无引线 (SON) 3.3mm x 3.3mm 塑料封装	13 英寸卷带	2500	卷带封装

## 绝对最大额定值

T <sub>A</sub> =25°C		值	单位
V <sub>DS</sub>	漏源电压	30	V
V <sub>GS</sub>	栅源电压	+10/-8	V
I <sub>D</sub>	持续漏极电流, T <sub>C</sub> =25°C 时测得 <sup>(1)</sup>	27	A
I <sub>DM</sub>	脉冲漏极电流 <sup>(2)</sup>	45	A
P <sub>D</sub>	功率耗散	2.5	W
T <sub>J</sub> , T <sub>STG</sub>	运行结温和储存温度范围	-55 至 150	°C
E <sub>AS</sub>	雪崩能量, 单一脉冲 I <sub>D</sub> =24A, L=0.1mH, R <sub>G</sub> =25Ω	29	mJ

(1) R=63°C/W, 这是在厚度为 0.060" 的环氧板印刷电路板 (FR4PCB) 上 1 in<sup>2</sup> (2 盎司) 铜过渡垫片上测得的典型值

(2) 脉冲持续时间 ≤ 300μs, 占空比 ≤ 2%

俯视图

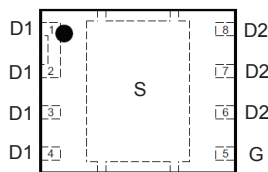

电路图象

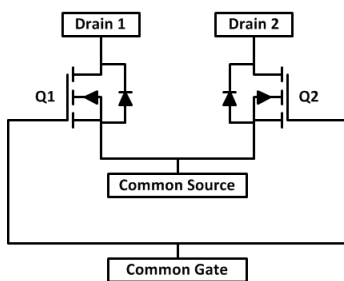

V<sub>GS</sub>与 R<sub>DDon</sub>间的关系

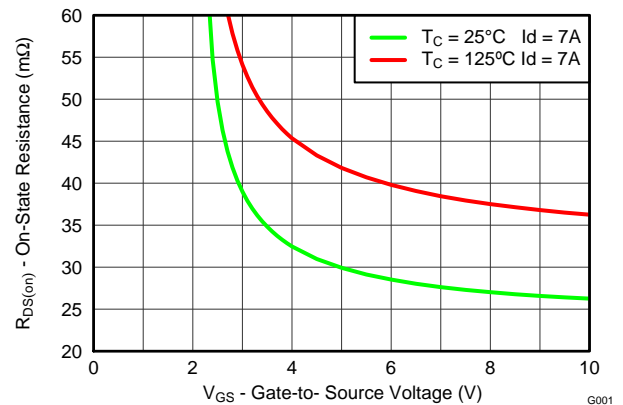

Please be aware that an important notice concerning availability, standard warranty, and use in critical applications of Texas Instruments semiconductor products and disclaimers thereto appears at the end of this data sheet.



These devices have limited built-in ESD protection. The leads should be shorted together or the device placed in conductive foam during storage or handling to prevent electrostatic damage to the MOS gates.

## ELECTRICAL CHARACTERISTICS

( $T_A = 25^\circ\text{C}$  unless otherwise stated)

PARAMETER		TEST CONDITIONS	MIN	TYP	MAX	UNIT
<b>Static Characteristics</b>						
$BV_{DSS}$	Drain to Source Voltage	$V_{GS} = 0V, I_D = 250\mu A$	30			V
$I_{DSS}$	Drain to Source Leakage Current	$V_{GS} = 0V, V_{DS} = 24V$			1	$\mu A$
$I_{GSS}$	Gate to Source Leakage Current	$V_{DS} = 0V, V_{GS} = +10/-8V$			100	nA
$V_{GS(th)}$	Gate to Source Threshold Voltage	$V_{DS} = V_{GS}, I_D = 250\mu A$	0.8	1.0	1.3	V
$R_{DD(on)}$	Drain to Drain On Resistance (Q1 + Q2)	$V_{GS} = 4.5V, I_D = 7A$		31	38	$m\Omega$
		$V_{GS} = 8V, I_D = 7A$		27	33	$m\Omega$
$g_{fs}$	Transconductance	$V_{DS} = 15V, I_D = 7A$		39		S
<b>Dynamic Characteristics<sup>(1)</sup></b>						
$C_{iss}$	Input Capacitance	$V_{GS} = 0V, V_{DS} = 15V, f = 1MHz$		960	1250	pF
$C_{oss}$	Output Capacitance			190	247	pF
$C_{riss}$	Reverse Transfer Capacitance			12	16	pF
$R_G$	Series Gate Resistance			5	10	$\Omega$
$Q_g$	Gate Charge Total (4.5V)	$V_{DS} = 15V, I_D = 7A$		6.3	8.2	nC
$Q_{gd}$	Gate Charge Gate to Drain			0.7		nC
$Q_{gs}$	Gate Charge Gate to Source			1.9		nC
$Q_{g(th)}$	Gate Charge at $V_{th}$			1.0		nC
$Q_{oss}$	Output Charge	$V_{DS} = 15V, V_{GS} = 0V$		4.0		nC
$t_{d(on)}$	Turn On Delay Time	$V_{DS} = 15V, V_{GS} = 4.5V, I_{DS} = 7A, R_G = 2\Omega$		7.8		ns
$t_r$	Rise Time			16		ns
$t_{d(off)}$	Turn Off Delay Time			17		ns
$t_f$	Fall Time			2.9		ns
<b>Diode Characteristics<sup>(1)</sup></b>						
$V_{SD}$	Diode Forward Voltage	$I_{SD} = 7A, V_{GS} = 0V$		0.8	1	V
$Q_{rr}$	Reverse Recovery Charge	$V_{DS} = 15V, I_F = 7A, di/dt = 300A/\mu s$		5.3		nC
$t_{rr}$	Reverse Recovery Time			12.2		ns

(1) All Dynamic and Diode Characteristics were measured with respect to one of the two drains, with the other left floating.

## THERMAL CHARACTERISTICS

( $T_A = 25^\circ\text{C}$  unless otherwise stated)

PARAMETER		MIN	TYP	MAX	UNIT
$R_{\theta JC}$	Thermal Resistance Junction to Case <sup>(1)</sup>			4.2	$^\circ\text{C}/W$
$R_{\theta JA}$	Thermal Resistance Junction to Ambient <sup>(1)(2)</sup>			63	$^\circ\text{C}/W$

- (1)  $R_{\theta JC}$  is determined with the device mounted on a 1-inch<sup>2</sup> (6.45-cm<sup>2</sup>), 2-oz. (0.071-mm thick) Cu pad on a 1.5-inch x 1.5-inch (3.81-cm x 3.81-cm), 0.06-inch (1.52-mm) thick FR4 PCB.  $R_{\theta JC}$  is specified by design, whereas  $R_{\theta JA}$  is determined by the user's board design.
- (2) Device mounted on FR4 material with 1-inch<sup>2</sup> (6.45-cm<sup>2</sup>), 2-oz. (0.071-mm thick) Cu.

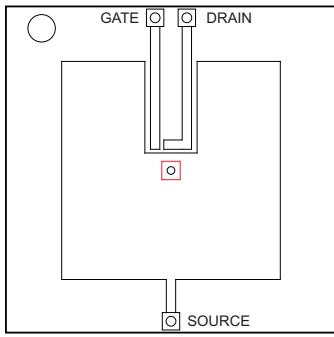

Max  $R_{\theta JA} = 63^{\circ}\text{C/W}$   
when mounted on  
1 inch<sup>2</sup> (6.45 cm<sup>2</sup>) of 2-  
oz. (0.071-mm thick)  
Cu.

M0137-01

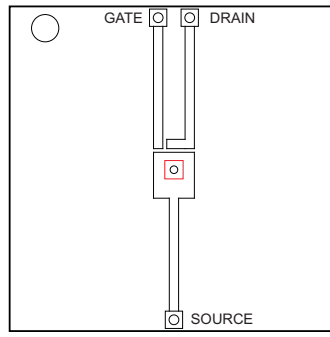

Max  $R_{\theta JA} = 165^{\circ}\text{C/W}$   
when mounted on a  
minimum pad area of  
2-oz. (0.071-mm thick)  
Cu.

M0137-02

**TYPICAL MOSFET CHARACTERISTICS**

( $T_A = 25^{\circ}\text{C}$  unless otherwise stated)

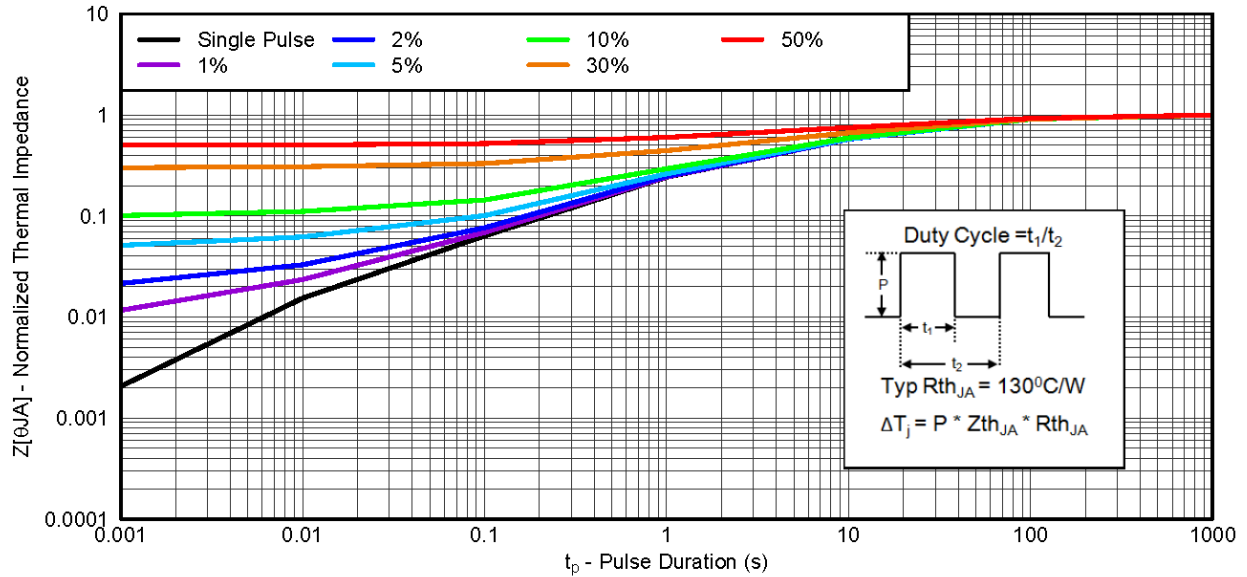

G001

Figure 1. Transient Thermal Impedance

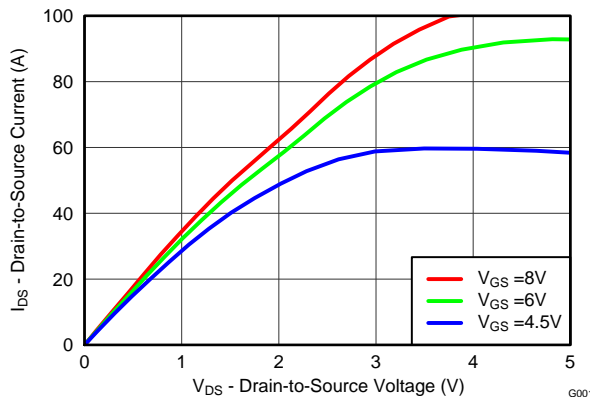

G001

Figure 2. Saturation Characteristics

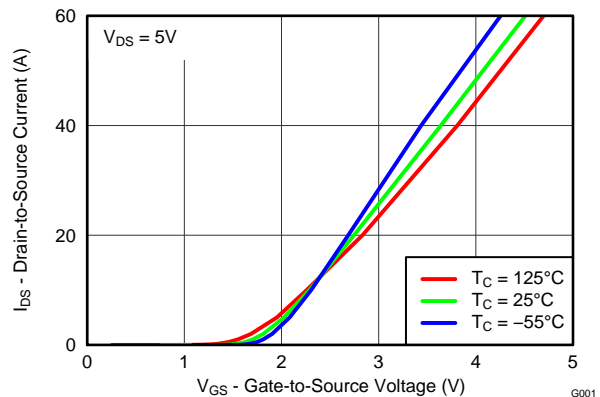

G001

Figure 3. Transfer Characteristics

**TYPICAL MOSFET CHARACTERISTICS (continued)**

( $T_A = 25^\circ\text{C}$  unless otherwise stated)

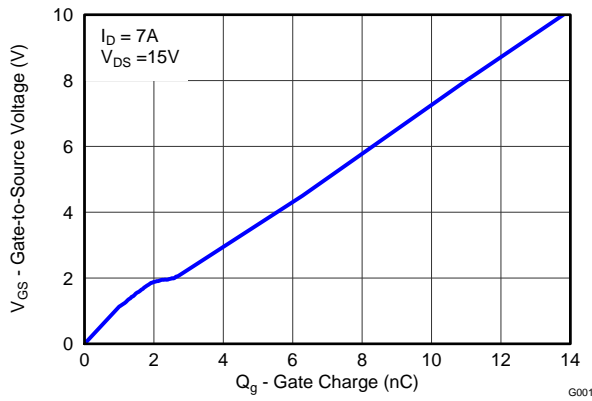

**Figure 4. Gate Charge**

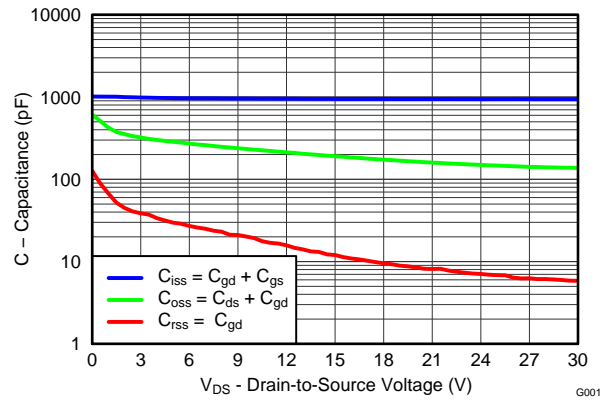

**Figure 5. Capacitance**

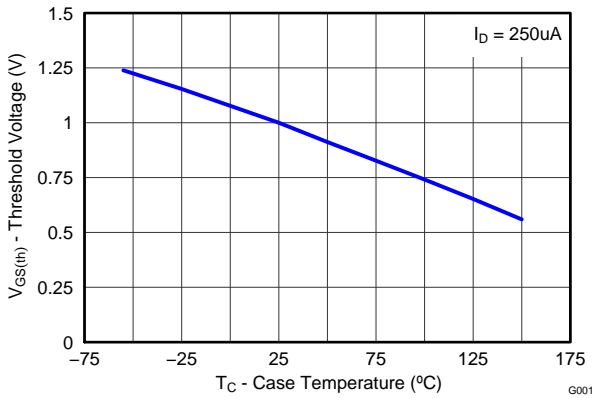

**Figure 6. Threshold Voltage vs. Temperature**

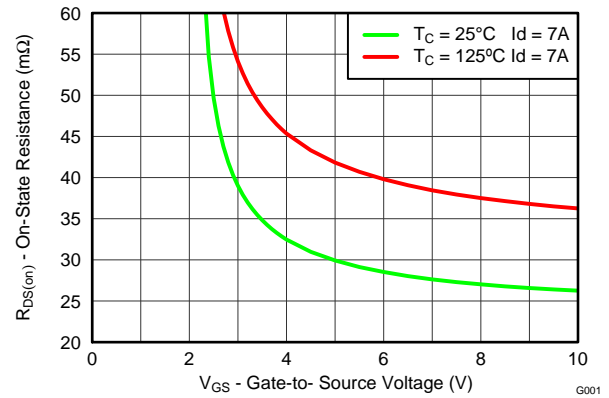

**Figure 7. On-State Resistance vs. Gate-to-Source Voltage**

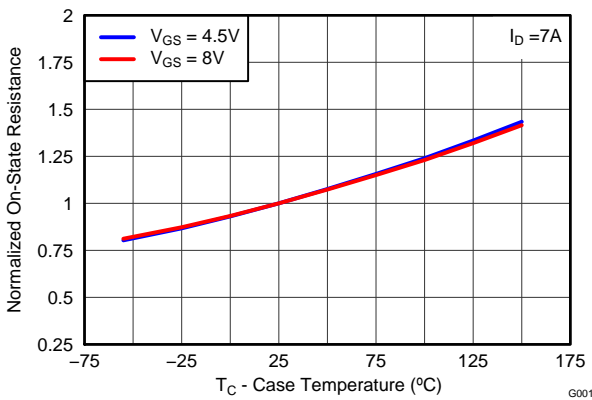

**Figure 8. Normalized On-State Resistance vs. Temperature**

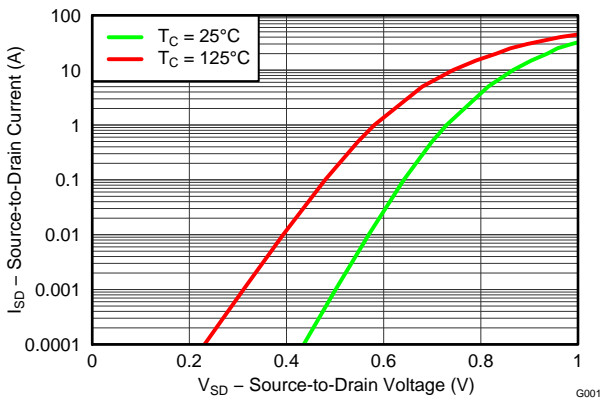

**Figure 9. Typical Diode Forward Voltage**

TYPICAL MOSFET CHARACTERISTICS (continued)

( $T_A = 25^\circ\text{C}$  unless otherwise stated)

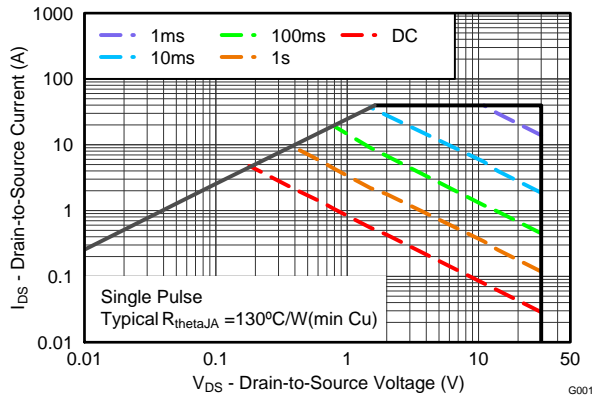

Figure 10. Maximum Safe Operating Area

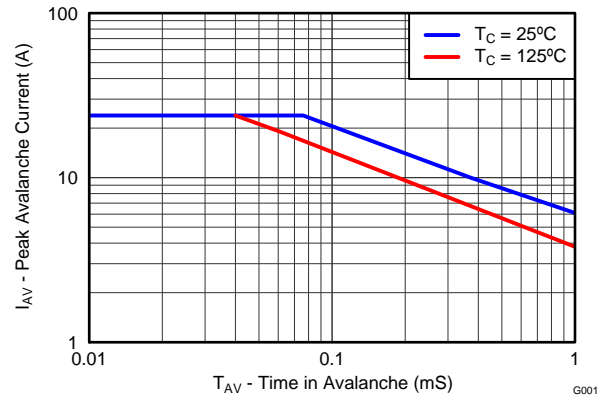

Figure 11. Single Pulse Unclamped Inductive Switching

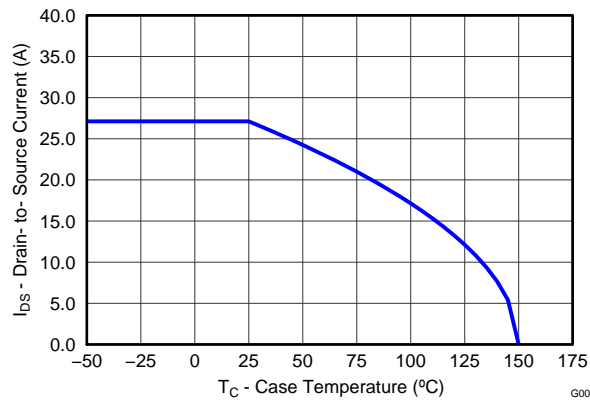
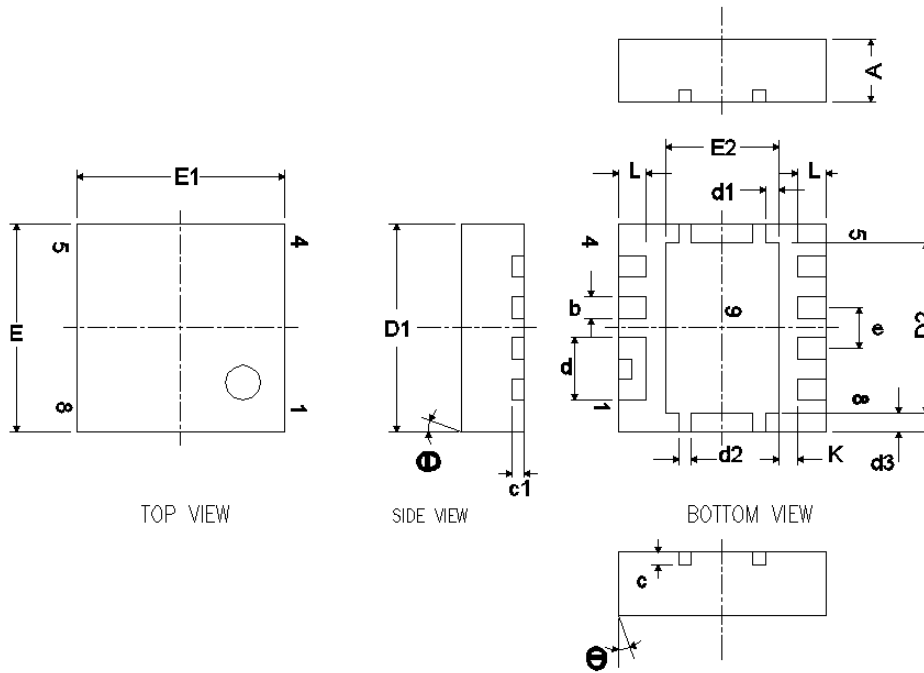

Figure 12. Maximum Drain Current vs. Temperature

MECHANICAL DATA

Q3E Package Dimensions



DIM	MILLIMETERS	
	MIN	MAX
A	0.850	1.050
b	0.280	0.400
c	0.150	0.250
c1	0.150	0.250
d	0.940	1.040
d1	0.160	0.260
d2	0.150	0.250
d3	0.250	0.350
D1	3.200	3.400
D2	2.650	2.750
E	3.200	3.400
E1	3.200	3.400
E2	1.750	1.850
e	0.650 TYP	
L	0.400	0.500
$\theta$	0°	-
K	0.300 Typ	

Notes:

1. Pin 1-4: Drain 1
2. Pin 5: Gate
3. Pin 6-8: Drain 2
4. Pin 9: Source

### Recommended PCB Pattern

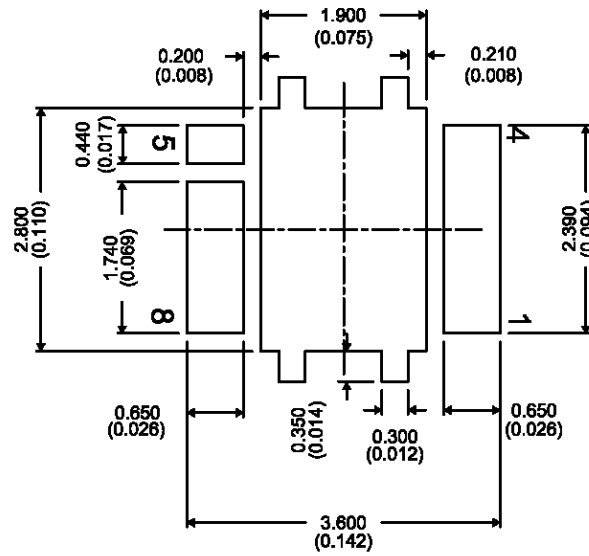

### Recommended Stencil Opening

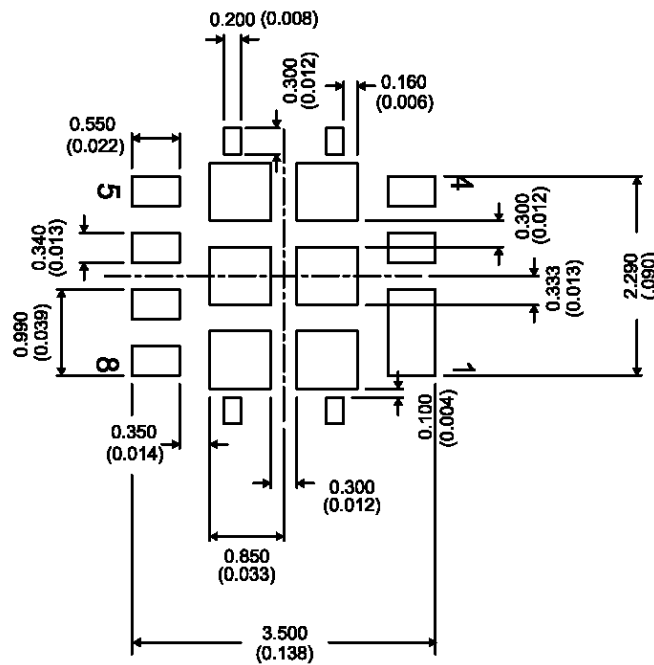

For recommended circuit layout for PCB designs, see application note [SLPA005](#) – *Reducing Ringing Through PCB Layout Techniques*.

**Q3E Tape and Reel Information**

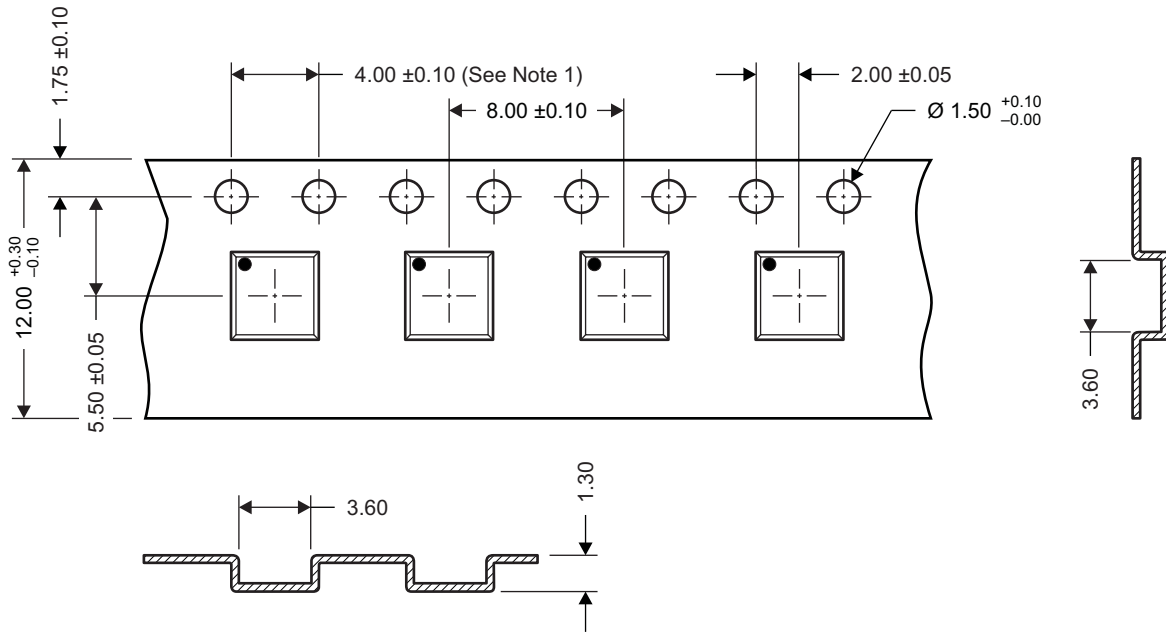

M0144-01

**Notes:**

1. 10 sprocket hole pitch cumulative tolerance  $\pm 0.2$
2. Camber not to exceed 1mm IN 100mm, noncumulative over 250mm
3. Material: black static dissipative polystyrene
4. All dimensions are in mm (unless otherwise specified)
5. Thickness:  $0.30 \pm 0.05$ mm
6. MSL1 260°C (IR and Convection) PbF Reflow Compatible



**PACKAGING INFORMATION**

Orderable Device	Status (1)	Package Type	Package Drawing	Pins	Package Qty	Eco Plan (2)	Lead finish/ Ball material (6)	MSL Peak Temp (3)	Op Temp (°C)	Device Marking (4/5)	Samples
CSD87312Q3E	ACTIVE	VSON-CLIP	DPB	8	2500	RoHS-Exempt & Green	NIPDAU	Level-1-260C-UNLIM	-55 to 150	87312E	<b>Samples</b>

(1) The marketing status values are defined as follows:

**ACTIVE:** Product device recommended for new designs.

**LIFEBUY:** TI has announced that the device will be discontinued, and a lifetime-buy period is in effect.

**NRND:** Not recommended for new designs. Device is in production to support existing customers, but TI does not recommend using this part in a new design.

**PREVIEW:** Device has been announced but is not in production. Samples may or may not be available.

**OBSOLETE:** TI has discontinued the production of the device.

(2) **RoHS:** TI defines "RoHS" to mean semiconductor products that are compliant with the current EU RoHS requirements for all 10 RoHS substances, including the requirement that RoHS substance do not exceed 0.1% by weight in homogeneous materials. Where designed to be soldered at high temperatures, "RoHS" products are suitable for use in specified lead-free processes. TI may reference these types of products as "Pb-Free".

**RoHS Exempt:** TI defines "RoHS Exempt" to mean products that contain lead but are compliant with EU RoHS pursuant to a specific EU RoHS exemption.

**Green:** TI defines "Green" to mean the content of Chlorine (Cl) and Bromine (Br) based flame retardants meet JS709B low halogen requirements of <=100ppm threshold. Antimony trioxide based flame retardants must also meet the <=1000ppm threshold requirement.

(3) MSL, Peak Temp. - The Moisture Sensitivity Level rating according to the JEDEC industry standard classifications, and peak solder temperature.

(4) There may be additional marking, which relates to the logo, the lot trace code information, or the environmental category on the device.

(5) Multiple Device Markings will be inside parentheses. Only one Device Marking contained in parentheses and separated by a "~" will appear on a device. If a line is indented then it is a continuation of the previous line and the two combined represent the entire Device Marking for that device.

(6) Lead finish/Ball material - Orderable Devices may have multiple material finish options. Finish options are separated by a vertical ruled line. Lead finish/Ball material values may wrap to two lines if the finish value exceeds the maximum column width.

**Important Information and Disclaimer:**The information provided on this page represents TI's knowledge and belief as of the date that it is provided. TI bases its knowledge and belief on information provided by third parties, and makes no representation or warranty as to the accuracy of such information. Efforts are underway to better integrate information from third parties. TI has taken and continues to take reasonable steps to provide representative and accurate information but may not have conducted destructive testing or chemical analysis on incoming materials and chemicals. TI and TI suppliers consider certain information to be proprietary, and thus CAS numbers and other limited information may not be available for release.

In no event shall TI's liability arising out of such information exceed the total purchase price of the TI part(s) at issue in this document sold by TI to Customer on an annual basis.

## 重要声明和免责声明

TI 均以“原样”提供技术性及其可靠性数据（包括数据表）、设计资源（包括参考设计）、应用或其他设计建议、网络工具、安全信息和其他资源，不保证其中不含任何瑕疵，且不做任何明示或暗示的担保，包括但不限于对适销性、适合某特定用途或不侵犯任何第三方知识产权的暗示担保。

所述资源可供专业开发人员应用TI 产品进行设计使用。您将对以下行为独自承担全部责任：(1) 针对您的应用选择合适的TI 产品；(2) 设计、验证并测试您的应用；(3) 确保您的应用满足相应标准以及任何其他安全、安保或其他要求。所述资源如有变更，恕不另行通知。TI 对您使用所述资源的授权仅限于开发资源所涉及TI 产品的相关应用。除此之外不得复制或展示所述资源，也不提供其它TI 或任何第三方的知识产权授权许可。如因使用所述资源而产生任何索赔、赔偿、成本、损失及债务等，TI 对此概不负责，并且您须赔偿由此对TI 及其代表造成的损害。

TI 所提供产品均受TI 的销售条款 (<http://www.ti.com.cn/zh-cn/legal/termsofsale.html>) 以及ti.com.cn 上或随附TI 产品提供的其他可适用条款的约束。TI 提供所述资源并不扩展或以其他方式更改TI 针对TI 产品所发布的可适用的担保范围或担保免责声明。

邮寄地址：上海市浦东新区世纪大道 1568 号中建大厦 32 楼，邮政编码：200122

Copyright © 2020 德州仪器半导体技术（上海）有限公司