

# CSD88537ND 双路 60V N 通道 NexFET™ 功率金属氧化物半导体场效应晶体管 (MOSFET)

## 1 特性

- 超低  $Q_g$  和  $Q_{gd}$
- 雪崩额定值
- 无铅
- 符合 RoHS 环保标准
- 无卤素

## 2 应用范围

- 用于电机控制的半桥
- 同步降压转换器

## 3 说明

这款双路小外形尺寸 (SO)-8, 60V, 12.5m $\Omega$

NexFET™ 功率 MOSFET 旨在用作低电流电机控制应用中的半桥。

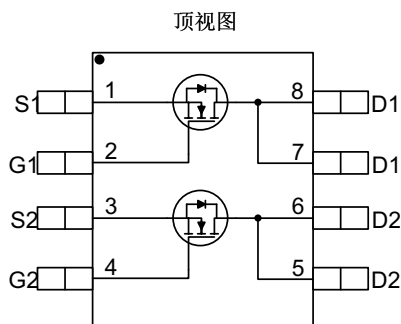

### 产品概要

$T_A = 25^\circ\text{C}$		典型值		单位
$V_{DS}$	漏源电压	60		V
$Q_g$	栅极电荷总量 (10V)	14		nC
$Q_{gd}$	栅漏栅极电荷	2.3		nC
$R_{DS(on)}$	漏源导通电阻	$V_{GS} = 6V$	15	m $\Omega$
		$V_{GS} = 10V$	12.5	m $\Omega$
$V_{GS(th)}$	阈值电压	3.0		V

### 订购信息<sup>(1)</sup>

器件	介质	数量	封装	出货
CSD88537ND	13 英寸卷带	2500	SO-8 塑料封装	卷带封装
CSD88537NDT	7 英寸卷带	250		

(1) 要了解所有可用封装, 请见数据表末尾的可订购产品附录。

### 最大绝对额定值

$T_A = 25^\circ\text{C}$		值	单位
$V_{DS}$	漏源电压	60	V
$V_{GS}$	栅源电压	$\pm 20$	V
$I_D$	持续漏极电流 (受封装限制)	15	A
	持续漏极电流 (受芯片限制), $T_C = 25^\circ\text{C}$ 时测得	16	
	持续漏极电流 <sup>(1)</sup>	8.0	
$I_{DM}$	脉冲漏极电流, $T_A = 25^\circ\text{C}$ 时测得 <sup>(2)</sup>	108	A
$P_D$	功率耗散 <sup>(1)</sup>	2.1	W
$T_J, T_{stg}$	运行结温和储存温度范围	-55 至 150	$^\circ\text{C}$
$E_{AS}$	雪崩能量, 单脉冲 $I_D = 32, L = 0.1\text{mH}, R_G = 25\Omega$	51	mJ

(1)  $R_{\theta JA} = 60^\circ\text{C}/\text{W}$ , 这是在一个厚度 0.06 英寸环氧树脂 (FR4) 印刷电路板 (PCB) 上的 1 英寸<sup>2</sup>, 2 盎司的铜焊盘上测得的典型值。

(2) 最大  $R_{\theta JL} = 20^\circ\text{C}/\text{W}$ , 脉冲持续时间  $\leq 100\mu\text{s}$ , 占空比  $\leq 1\%$



**$R_{DS(on)}$  与  $V_{GS}$  间的关系**

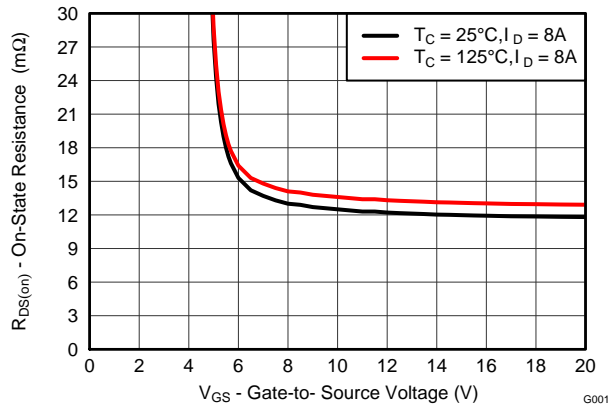

**栅极电荷**

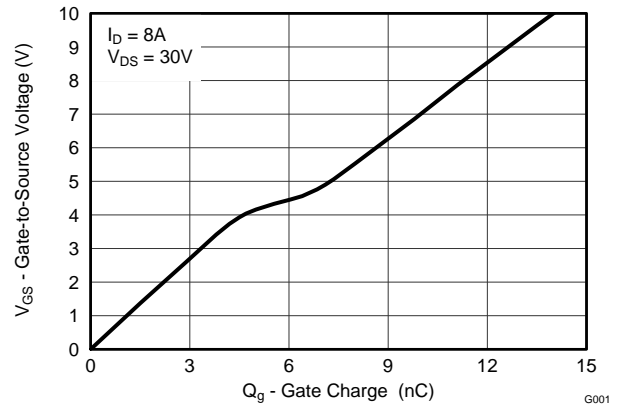

## 目录

<b>1 特性</b> ..... 1 <b>2 应用范围</b> ..... 1 <b>3 说明</b> ..... 1 <b>4 修订历史记录</b> ..... 3 <b>5 Specifications</b> ..... 4 5.1 Electrical Characteristics ..... 4 5.2 Thermal Information ..... 4	5.3 Typical MOSFET Characteristics ..... 5 <b>6 器件和文档支持</b> ..... 8 6.1 商标 ..... 8 6.2 静电放电警告 ..... 8 6.3 术语表 ..... 8 <b>7 机械封装和可订购信息</b> ..... 9 7.1 SO-8 封装尺寸 ..... 9 7.2 建议的 PCB 模板布局和开口 ..... 10
--	---

## 4 修订历史记录

Changes from Original (January 2014) to Revision A	Page
• 已将脉冲漏极电流从 62A 增加为 108A .....	1
• 更新了脉冲漏极电流条件 .....	1
• Changed $R_{\theta JC}$ to $R_{\theta JL}$ in <i>Thermal Information</i> .....	4
• Updated the SOA in <a href="#">Figure 10</a> .....	7

## 5 Specifications

### 5.1 Electrical Characteristics

 ( $T_A = 25^\circ\text{C}$  unless otherwise stated)

PARAMETER		TEST CONDITIONS	MIN	TYP	MAX	UNIT
<b>STATIC CHARACTERISTICS</b>						
$V_{DSS}$	Drain-to-Source Voltage	$V_{GS} = 0\text{ V}, I_D = 250\ \mu\text{A}$	60			V
$I_{DSS}$	Drain-to-Source Leakage Current	$V_{GS} = 0\text{ V}, V_{DS} = 48\text{ V}$			1	$\mu\text{A}$
$I_{GSS}$	Gate-to-Source Leakage Current	$V_{DS} = 0\text{ V}, V_{GS} = 20\text{ V}$			100	nA
$V_{GS(th)}$	Gate-to-Source Threshold Voltage	$V_{DS} = V_{GS}, I_D = 250\ \mu\text{A}$	2.6	3	3.6	V
$R_{DS(on)}$	Drain-to-Source On-Resistance	$V_{GS} = 6\text{ V}, I_D = 8\text{ A}$		15	19	m $\Omega$
		$V_{GS} = 10\text{ V}, I_D = 8\text{ A}$		12.5	15	m $\Omega$
$g_{fs}$	Transconductance	$V_{DS} = 30\text{ V}, I_D = 8\text{ A}$		42		S
<b>DYNAMIC CHARACTERISTICS</b>						
$C_{iss}$	Input Capacitance	$V_{GS} = 0\text{ V}, V_{DS} = 30\text{ V}, f = 1\text{ MHz}$		1080	1400	pF
$C_{oss}$	Output Capacitance			133	173	pF
$C_{rss}$	Reverse Transfer Capacitance			4	5.2	pF
$R_G$	Series Gate Resistance			5.5	11	$\Omega$
$Q_g$	Gate Charge Total (10 V)	$V_{DS} = 30\text{ V}, I_D = 8\text{ A}$		14	18	nC
$Q_{gd}$	Gate Charge Gate-to-Drain			2.3		nC
$Q_{gs}$	Gate Charge Gate-to-Source			4.6		nC
$Q_{g(th)}$	Gate Charge at $V_{th}$			3.4		nC
$Q_{oss}$	Output Charge	$V_{DS} = 30\text{ V}, V_{GS} = 0\text{ V}$		25		nC
$t_{d(on)}$	Turn On Delay Time	$V_{DS} = 30\text{ V}, V_{GS} = 10\text{ V}, I_{DS} = 8\text{ A}, R_G = 0\ \Omega$		6		ns
$t_r$	Rise Time			15		ns
$t_{d(off)}$	Turn Off Delay Time			5		ns
$t_f$	Fall Time			19		ns
<b>DIODE CHARACTERISTICS</b>						
$V_{SD}$	Diode Forward Voltage	$I_{SD} = 8\text{ A}, V_{GS} = 0\text{ V}$		0.8	1	V
$Q_{rr}$	Reverse Recovery Charge	$V_{DS} = 30\text{ V}, I_F = 8\text{ A}, di/dt = 300\text{ A}/\mu\text{s}$		50		nC
$t_{rr}$	Reverse Recovery Time			30		ns

### 5.2 Thermal Information

 ( $T_A = 25^\circ\text{C}$  unless otherwise stated)

THERMAL METRIC		MIN	TYP	MAX	UNIT
$R_{\theta JL}$	Junction-to-Lead Thermal Resistance <sup>(1)</sup>			20	$^\circ\text{C}/\text{W}$
$R_{\theta JA}$	Junction-to-Ambient Thermal Resistance <sup>(1)(2)</sup>			75	

- $R_{\theta JL}$  is determined with the device mounted on a 1-inch<sup>2</sup> (6.45-cm<sup>2</sup>), 2-oz. (0.071-mm thick) Cu pad on a 1.5-inches  $\times$  1.5-inches (3.81-cm  $\times$  3.81-cm), 0.06-inch (1.52-mm) thick FR4 PCB.  $R_{\theta JL}$  is specified by design, whereas  $R_{\theta JA}$  is determined by the user's board design.
- Device mounted on FR4 material with 1-inch<sup>2</sup> (6.45-cm<sup>2</sup>), 2-oz. (0.071-mm thick) Cu.

### 5.3 Typical MOSFET Characteristics

( $T_A = 25^\circ\text{C}$  unless otherwise stated)

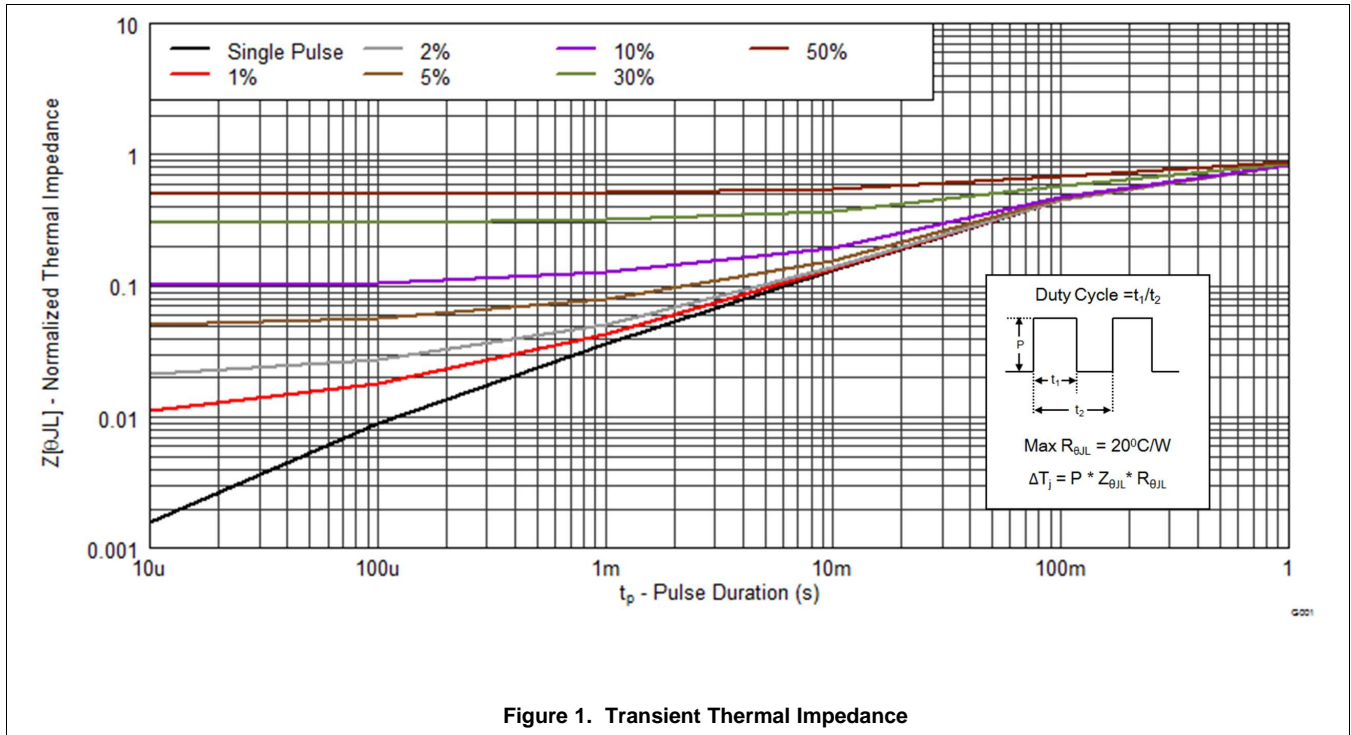

Figure 1. Transient Thermal Impedance

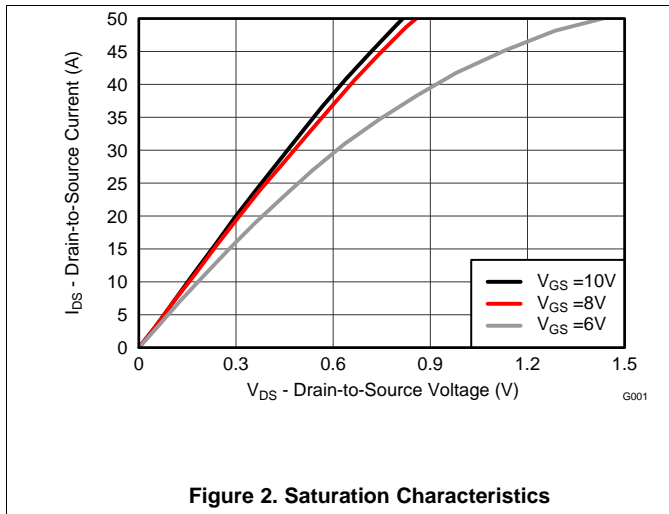

Figure 2. Saturation Characteristics

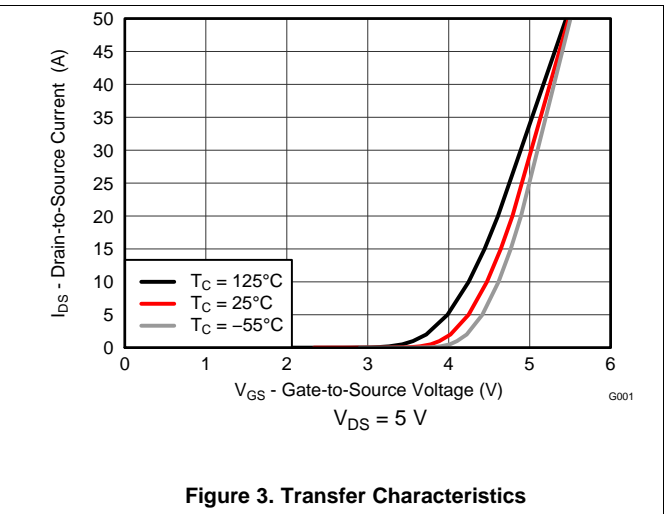
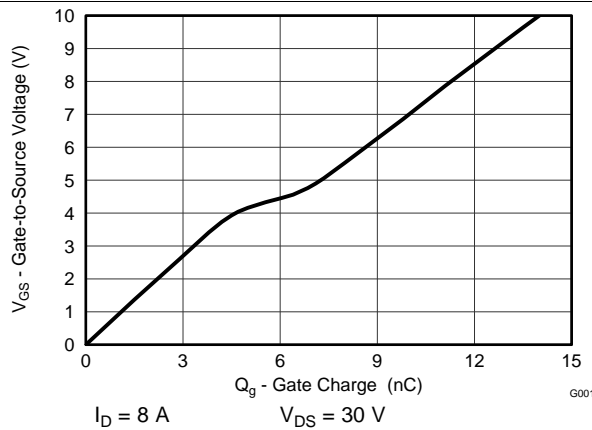

Figure 3. Transfer Characteristics

**Typical MOSFET Characteristics (continued)**

( $T_A = 25^\circ\text{C}$  unless otherwise stated)



**Figure 4. Gate Charge**

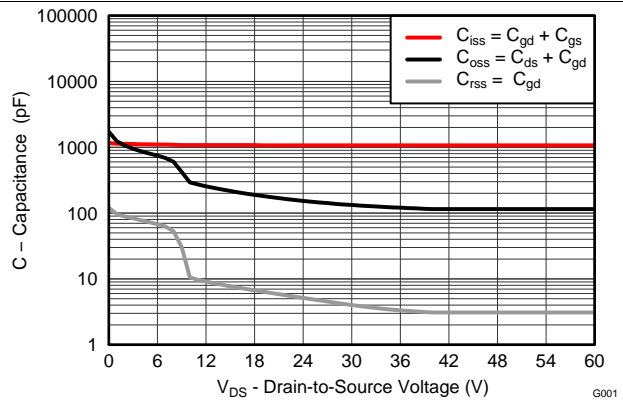

**Figure 5. Capacitance**

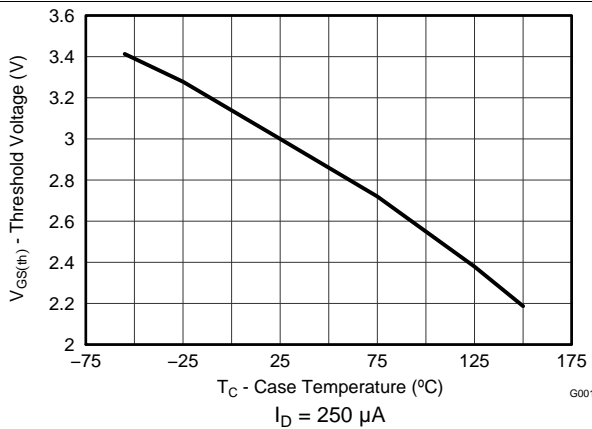

**Figure 6. Threshold Voltage vs Temperature**

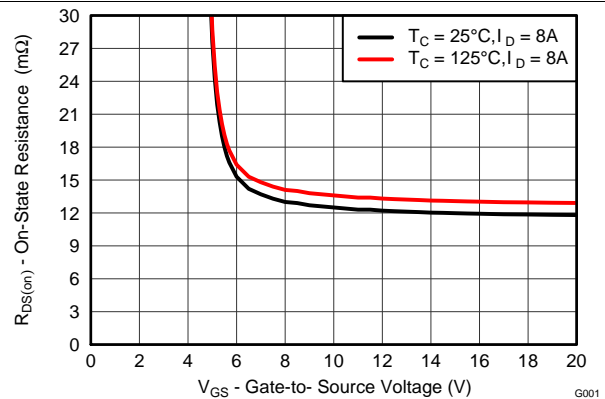

**Figure 7. On-State Resistance vs Gate-to-Source Voltage**

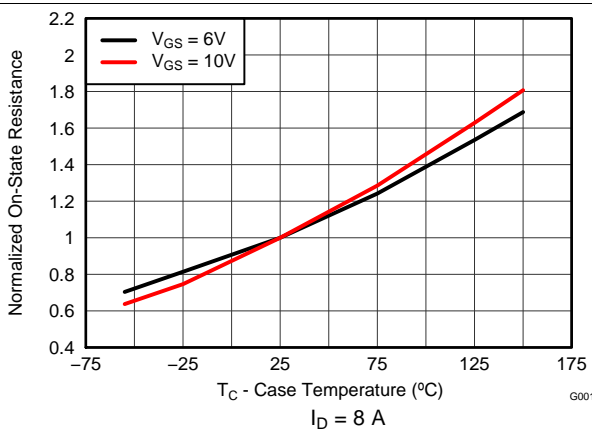

**Figure 8. Normalized On-State Resistance vs Temperature**

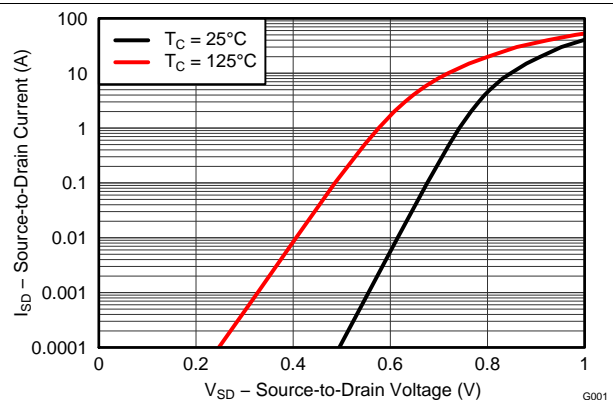

**Figure 9. Typical Diode Forward Voltage**

Typical MOSFET Characteristics (continued)

( $T_A = 25^\circ\text{C}$  unless otherwise stated)

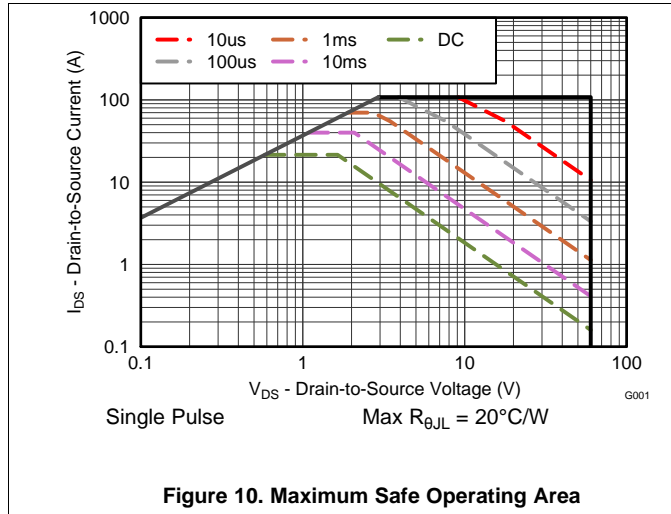

Figure 10. Maximum Safe Operating Area

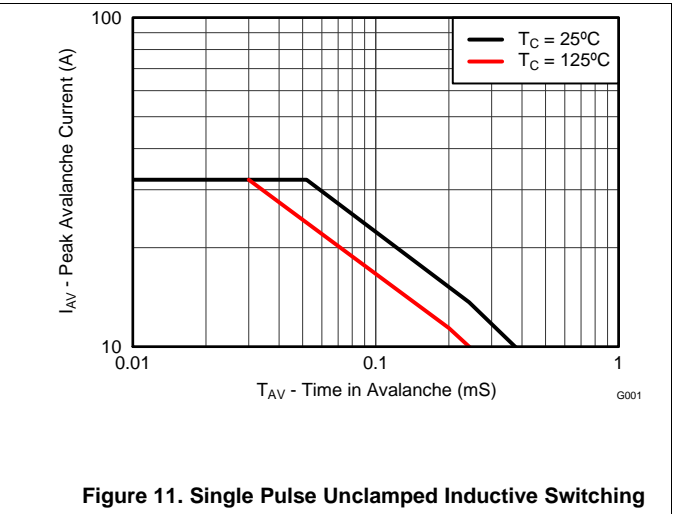

Figure 11. Single Pulse Unclamped Inductive Switching

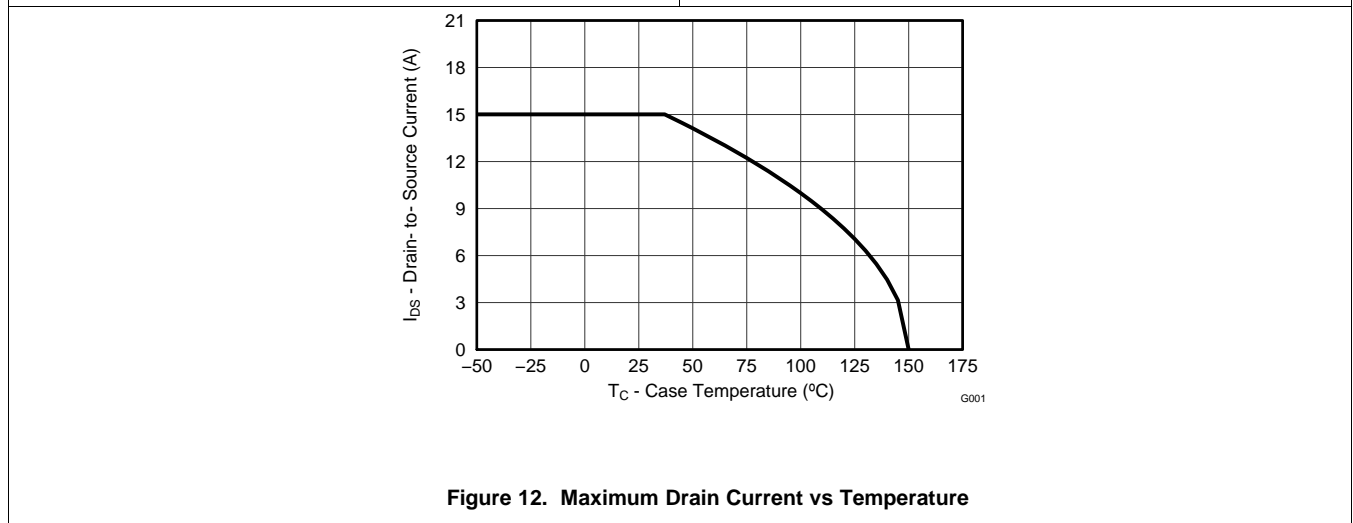

Figure 12. Maximum Drain Current vs Temperature

## 6 器件和文档支持

### 6.1 商标

NexFET is a trademark of Texas Instruments.

### 6.2 静电放电警告



这些装置包含有限的内置 ESD 保护。存储或装卸时，应将导线一起截短或将装置放置于导电泡棉中，以防止 MOS 门极遭受静电损伤。

### 6.3 术语表

[SLYZ022](#) — *TI* 术语表。

这份术语表列出并解释术语、首字母缩略词和定义。



## 7 机械封装和可订购信息

以下页中包括机械封装和可订购信息。 这些信息是针对指定器件可提供的最新数据。 这些数据会在无通知且不对本文档进行修订的情况下发生改变。 欲获得该数据表的浏览器版本，请查阅左侧的导航栏。

### 7.1 SO-8 封装尺寸

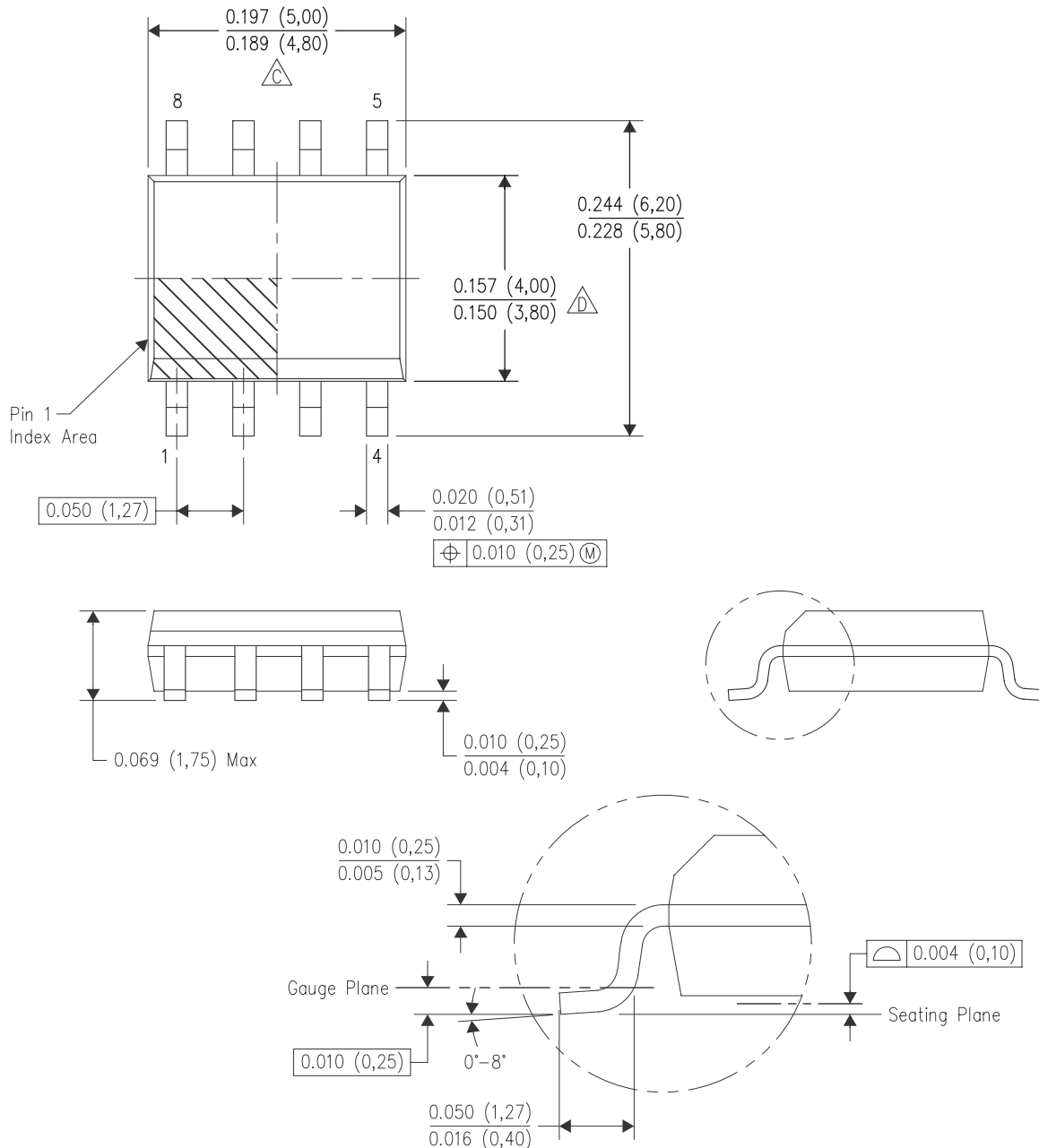

1. 所有线性尺寸的单位均为英寸（毫米）。
2. 本图纸如有变更，恕不通知。
3. 主体长度不包括模具毛边、突出或料口毛刺。 每侧的模具毛边、突出或料口毛刺不得超过 0.006 英寸（0.15 毫米）。
4. 主体宽度不包括引脚间的毛边。 每侧的引脚间毛边不得超过 0.017 英寸（0.43 毫米）。
5. 参考 JEDEC MS-012 变体 AA。

## 7.2 建议的 PCB 模板布局和开口

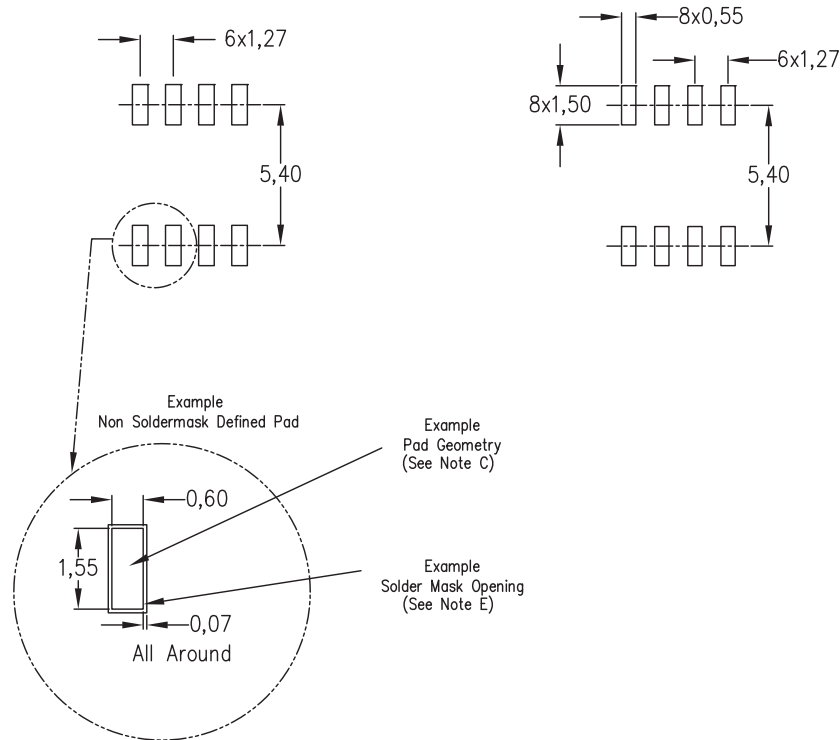

1. 所有线性尺寸的单位是毫米。
2. 本图纸如有变更，恕不通知。
3. 建议在替代设计中采用公布的 **IPC-7351** 标准。
4. 具有漏斗形壁和圆角的激光切割窗孔将提供最佳的焊锡膏脱离。 客户应联系其电路板组装站点获取漏网印板设计建议。 关于其他模板建议，请参见 **IPC-7525**。
5. 客户应联系其电路板生产厂获取有关信号盘之间以及信号盘周围的阻焊层容差的信息。

**PACKAGING INFORMATION**

Orderable Device	Status (1)	Package Type	Package Drawing	Pins	Package Qty	Eco Plan (2)	Lead finish/ Ball material (6)	MSL Peak Temp (3)	Op Temp (°C)	Device Marking (4/5)	Samples
CSD88537ND	ACTIVE	SOIC	D	8	2500	RoHS & Green	NIPDAU	Level-1-260C-UNLIM	-55 to 150	88537N	<a href="#">Samples</a>
CSD88537NDT	ACTIVE	SOIC	D	8	250	RoHS & Green	NIPDAU	Level-1-260C-UNLIM	-55 to 150	88537N	<a href="#">Samples</a>

(1) The marketing status values are defined as follows:

**ACTIVE:** Product device recommended for new designs.

**LIFEBUY:** TI has announced that the device will be discontinued, and a lifetime-buy period is in effect.

**NRND:** Not recommended for new designs. Device is in production to support existing customers, but TI does not recommend using this part in a new design.

**PREVIEW:** Device has been announced but is not in production. Samples may or may not be available.

**OBSOLETE:** TI has discontinued the production of the device.

(2) **RoHS:** TI defines "RoHS" to mean semiconductor products that are compliant with the current EU RoHS requirements for all 10 RoHS substances, including the requirement that RoHS substance do not exceed 0.1% by weight in homogeneous materials. Where designed to be soldered at high temperatures, "RoHS" products are suitable for use in specified lead-free processes. TI may reference these types of products as "Pb-Free".

**RoHS Exempt:** TI defines "RoHS Exempt" to mean products that contain lead but are compliant with EU RoHS pursuant to a specific EU RoHS exemption.

**Green:** TI defines "Green" to mean the content of Chlorine (Cl) and Bromine (Br) based flame retardants meet JS709B low halogen requirements of <=1000ppm threshold. Antimony trioxide based flame retardants must also meet the <=1000ppm threshold requirement.

(3) MSL, Peak Temp. - The Moisture Sensitivity Level rating according to the JEDEC industry standard classifications, and peak solder temperature.

(4) There may be additional marking, which relates to the logo, the lot trace code information, or the environmental category on the device.

(5) Multiple Device Markings will be inside parentheses. Only one Device Marking contained in parentheses and separated by a "~" will appear on a device. If a line is indented then it is a continuation of the previous line and the two combined represent the entire Device Marking for that device.

(6) Lead finish/Ball material - Orderable Devices may have multiple material finish options. Finish options are separated by a vertical ruled line. Lead finish/Ball material values may wrap to two lines if the finish value exceeds the maximum column width.

**Important Information and Disclaimer:**The information provided on this page represents TI's knowledge and belief as of the date that it is provided. TI bases its knowledge and belief on information provided by third parties, and makes no representation or warranty as to the accuracy of such information. Efforts are underway to better integrate information from third parties. TI has taken and continues to take reasonable steps to provide representative and accurate information but may not have conducted destructive testing or chemical analysis on incoming materials and chemicals. TI and TI suppliers consider certain information to be proprietary, and thus CAS numbers and other limited information may not be available for release.

In no event shall TI's liability arising out of such information exceed the total purchase price of the TI part(s) at issue in this document sold by TI to Customer on an annual basis.



**TAPE AND REEL INFORMATION**

**QUADRANT ASSIGNMENTS FOR PIN 1 ORIENTATION IN TAPE**

\*All dimensions are nominal

Device	Package Type	Package Drawing	Pins	SPQ	Reel Diameter (mm)	Reel Width W1 (mm)	A0 (mm)	B0 (mm)	K0 (mm)	P1 (mm)	W (mm)	Pin1 Quadrant
CSD88537NDT	SOIC	D	8	250	178.0	12.4	6.4	5.2	2.1	8.0	12.0	Q1

**TAPE AND REEL BOX DIMENSIONS**

\*All dimensions are nominal

Device	Package Type	Package Drawing	Pins	SPQ	Length (mm)	Width (mm)	Height (mm)
CSD88537NDT	SOIC	D	8	250	180.0	180.0	79.0



D0008A

# PACKAGE OUTLINE

SOIC - 1.75 mm max height

SMALL OUTLINE INTEGRATED CIRCUIT



4214825/C 02/2019

### NOTES:

- Linear dimensions are in inches [millimeters]. Dimensions in parenthesis are for reference only. Controlling dimensions are in inches. Dimensioning and tolerancing per ASME Y14.5M.
- This drawing is subject to change without notice.
- This dimension does not include mold flash, protrusions, or gate burrs. Mold flash, protrusions, or gate burrs shall not exceed .006 [0.15] per side.
- This dimension does not include interlead flash.
- Reference JEDEC registration MS-012, variation AA.

# EXAMPLE BOARD LAYOUT

D0008A

SOIC - 1.75 mm max height

SMALL OUTLINE INTEGRATED CIRCUIT



LAND PATTERN EXAMPLE  
 EXPOSED METAL SHOWN  
 SCALE:8X



SOLDER MASK DETAILS

4214825/C 02/2019

NOTES: (continued)

- 6. Publication IPC-7351 may have alternate designs.
- 7. Solder mask tolerances between and around signal pads can vary based on board fabrication site.



# EXAMPLE STENCIL DESIGN

D0008A

SOIC - 1.75 mm max height

SMALL OUTLINE INTEGRATED CIRCUIT



SOLDER PASTE EXAMPLE  
BASED ON .005 INCH [0.125 MM] THICK STENCIL  
SCALE:8X

4214825/C 02/2019

NOTES: (continued)

8. Laser cutting apertures with trapezoidal walls and rounded corners may offer better paste release. IPC-7525 may have alternate design recommendations.
9. Board assembly site may have different recommendations for stencil design.

## 重要声明和免责声明

TI“按原样”提供技术和可靠性数据（包括数据表）、设计资源（包括参考设计）、应用或其他设计建议、网络工具、安全信息和其他资源，不保证没有瑕疵且不做任何明示或暗示的担保，包括但不限于对适销性、某特定用途方面的适用性或不侵犯任何第三方知识产权的暗示担保。

这些资源可供使用 TI 产品进行设计的熟练开发人员使用。您将自行承担以下全部责任：(1) 针对您的应用选择合适的 TI 产品，(2) 设计、验证并测试您的应用，(3) 确保您的应用满足相应标准以及任何其他功能安全、信息安全、监管或其他要求。

这些资源如有变更，恕不另行通知。TI 授权您仅可将这些资源用于研发本资源所述的 TI 产品的应用。严禁对这些资源进行其他复制或展示。您无权使用任何其他 TI 知识产权或任何第三方知识产权。您应全额赔偿因在这些资源的使用中对 TI 及其代表造成的任何索赔、损害、成本、损失和债务，TI 对此概不负责。

TI 提供的产品受 [TI 的销售条款](#) 或 [ti.com](#) 上其他适用条款/TI 产品随附的其他适用条款的约束。TI 提供这些资源并不会扩展或以其他方式更改 TI 针对 TI 产品发布的适用的担保或担保免责声明。

TI 反对并拒绝您可能提出的任何其他或不同的条款。

邮寄地址：Texas Instruments, Post Office Box 655303, Dallas, Texas 75265

Copyright © 2022，德州仪器 (TI) 公司