

DS90LV027AH 高温 LVDS 双路差动驱动器

1 特性

- 工作温度范围为 -40°C 至 +125°C
- >600Mbps (300MHz) 转换速率
- 0.3ns 典型差动偏斜
- 0.7ns 最大差动偏斜
- 3.3V 电源设计
- 低功耗 (3.3V 静态条件下为 46mW)
- 直通式设计可简化 PCB 布局
- 断电保护 (高阻抗输出)
- 符合 TIA/EIA-644 标准
- 8 引脚 SOIC 封装节省空间

2 应用

- 板对板通信
- 测试和测量
- 电机驱动器
- LED 视频墙
- 无线基础设施
- 电信基础设施
- 多功能打印机
- NIC 卡
- 机架式服务器
- 超声波扫描仪

3 说明

DS90LV027AH 是一款双 LVDS 驱动器器件，已针对高数据速率和低功耗应用进行优化。该器件的设计旨在利用低电压差动信号 (LVDS) 技术支持超过 600Mbps (300MHz) 的数据速率。DS90LV027AH 是一款电流模式驱动器，即使在高频率条件下也能够保持低功耗。此外，它还能够最大限度地降低短路故障电流。

该器件采用 8 引线 SOIC 封装。DS90LV027AH 采用了直通式设计，可简化 PCB 布局。差动驱动器输出可提供低 EMI，其典型的低输出摆幅为 360mV。非常适合高速传输时钟和数据。DS90LV027AH 可与配套的双线接收器 DS90LV028AH 或任何 TI 的 LVDS 接收器配对，以提供高速点对点 LVDS 接口。

器件信息⁽¹⁾

器件型号	封装	封装尺寸 (标称值)
DS90LV027AH	SOIC (8)	4.90mm × 3.91mm

(1) 如需了解所有可用封装，请参阅产品说明书末尾的可订购产品附录。

通道 1 功能图

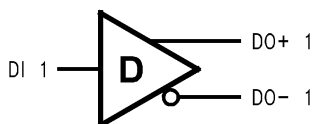

通道 2 功能图

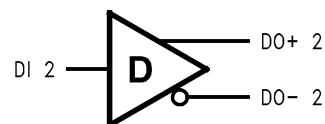

目录

1	特性	1	8.3	Feature Description	10
2	应用	1	8.4	Device Functional Modes	11
3	说明	1	9	Application and Implementation	12
4	修订历史记录	2	9.1	Application Information	12
5	Pin Configuration and Functions	3	9.2	Typical Application	12
6	Specifications	4	10	Power Supply Recommendations	16
6.1	Absolute Maximum Ratings	4	11	Layout	16
6.2	ESD Ratings	4	11.1	Layout Guidelines	16
6.3	Recommended Operating Conditions	4	11.2	Layout Example	20
6.4	Thermal Information	4	12	器件和文档支持	21
6.5	Electrical Characteristics	5	12.1	相关文档	21
6.6	Switching Characteristics	5	12.2	接收文档更新通知	21
6.7	Typical Characteristics	6	12.3	社区资源	21
7	Parameter Measurement Information	9	12.4	商标	21
8	Detailed Description	10	12.5	静电放电警告	21
8.1	Overview	10	12.6	术语表	21
8.2	Functional Block Diagrams	10	13	机械、封装和可订购信息	21

4 修订历史记录

注：之前版本的页码可能与当前版本有所不同。

Changes from Revision A (April 2013) to Revision B	Page
• 添加了器件信息表、器件比较表、ESD 额定值表、特性说明部分、设备功能模块、应用和实施部分、器件和文档支持部分以及机械、封装和可订购信息部分。	1
• 添加了导航链接，移除了数据表页顶端的 NRND 横幅	1
• Moved the thermal resistance (θ_{JA}) parameter in the <i>Absolute Maximum Ratings</i> table to the <i>Thermal Information</i> table	4

Changes from Original (April 2013) to Revision A	Page
• Changed layout of National Data Sheet to TI format	7

5 Pin Configuration and Functions

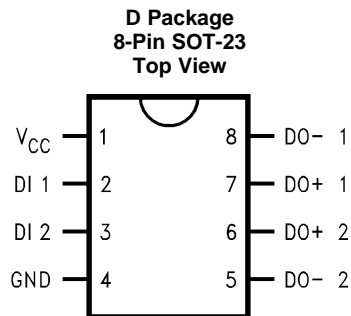

Pin Functions

PIN		I/O	DESCRIPTION
NAME	NO.		
DI	2, 3	I	TTL/CMOS driver input pins
DO+	6, 7	O	Non-inverting driver output pin
DO-	5, 8	O	Inverting driver output pin
GND	4	I	Ground pin
V _{CC}	1	I	Positive power supply pin, +3.3 V ± 0.3 V

6 Specifications

6.1 Absolute Maximum Ratings ⁽¹⁾

		MIN	MAX	UNIT
Supply Voltage (V_{CC})		-0.3V	4	V
Input Voltage (DI)		-0.3V	3.6	V
Output Voltage (DO \pm)		-0.3V	3.9	V
Maximum Package Power Dissipation at +25°C	D Package		1190	mW
	Derate D Package (above +25°C)		9.5	mW/°C
Storage Temperature, T_{stg}		-65	150	°C

- (1) Stresses beyond those listed under *Absolute Maximum Ratings* may cause permanent damage to the device. These are stress ratings only, which do not imply functional operation of the device at these or any other conditions beyond those indicated under *Recommended Operating Conditions*. Exposure to absolute-maximum-rated conditions for extended periods may affect device reliability.

6.2 ESD Ratings

		VALUE	UNIT
$V_{(ESD)}$ Electrostatic discharge	Human-body model (HBM), per ANSI/ESDA/JEDEC JS-001 ⁽¹⁾ (1.5 k Ω , 100 pF)	8000	V
	Charged-device model (CDM), per JEDEC specification JESD22-C101 ⁽²⁾	1000	
	EIAJ (0 Ω , 200 pF)	1000	
	IEC (direct 330 Ω , 150 pF)	4000	

- (1) JEDEC document JEP155 states that 500-V HBM allows safe manufacturing with a standard ESD control process. Pins listed as ± 8000 V may actually have higher performance.
- (2) JEDEC document JEP157 states that 250-V CDM allows safe manufacturing with a standard ESD control process. Pins listed as ± 1000 V may actually have higher performance.

6.3 Recommended Operating Conditions

	MIN	TYP	MAX	UNIT
Supply Voltage (V_{CC})	3	3.3	3.6	V
Ambient Temperature (T_A)	-40	25	+125	°C
Junction Temperature (T_J)			+130	°C

6.4 Thermal Information

THERMAL METRIC ⁽¹⁾		DS90LV027AH	UNIT
		D (SOIC)	
		8 PINS	
$R_{\theta JA}$	Junction-to-ambient thermal resistance	123.2	°C/W
$R_{\theta JC(top)}$	Junction-to-case (top) thermal resistance	63.5	°C/W
$R_{\theta JB}$	Junction-to-board thermal resistance	65.8	°C/W
Ψ_{JT}	Junction-to-top characterization parameter	13.7	°C/W
Ψ_{JB}	Junction-to-board characterization parameter	65.2	°C/W

- (1) For more information about traditional and new thermal metrics, see the [Semiconductor and IC Package Thermal Metrics](#) application report.

6.5 Electrical Characteristics

Over Supply Voltage and Operating Temperature ranges, unless otherwise specified. ⁽¹⁾ ⁽²⁾ ⁽³⁾

PARAMETER		TEST CONDITIONS	PIN	MIN	TYP	MAX	UNIT
DIFFERENTIAL DRIVER CHARACTERISTICS							
V _{OD}	Output Differential Voltage	R _L = 100Ω (Figure 15)	DO+, DO-	250	360	450	mV
ΔV _{OD}	V _{OD} Magnitude Change			1	35	mV	
V _{OH}	Output High Voltage			1.4	1.6	V	
V _{OL}	Output Low Voltage			0.9	1.1	V	
V _{OS}	Offset Voltage			1.125	1.2	1.375	V
ΔV _{OS}	Offset Magnitude Change			0	3	25	mV
I _{OXD}	Power-off Leakage			V _{OUT} = V _{CC} or GND, V _{CC} = 0V		±1	±10
I _{OSD}	Output Short Circuit Current			-5.7	-8	mA	
V _{IH}	Input High Voltage		DI	2.0		V _{CC}	V
V _{IL}	Input Low Voltage			GND		0.8	V
I _{IH}	Input High Current	V _{IN} = 3.3V or 2.4V			±2	±10	μA
I _{IL}	Input Low Current	V _{IN} = GND or 0.5V		±1	±10	μA	
V _{CL}	Input Clamp Voltage	I _{CL} = -18 mA		-1.5	-0.6		V
I _{CC}	Power Supply Current	No Load	V _{IN} = V _{CC} or GND	V _{CC}	8	14	mA
		R _L = 100Ω			14	20	mA

- (1) Current into device pins is defined as positive. Current out of device pins is defined as negative. All voltages are referenced to ground except V_{OD}.
- (2) All typicals are given for: V_{CC} = +3.3 V and T_A = +25°C.
- (3) The DS90LV027AH is a current mode device and only function with datasheet specification when a resistive load is applied to the drivers outputs.

6.6 Switching Characteristics

Over Supply Voltage and Operating Temperature Ranges, unless otherwise specified. ⁽¹⁾ ⁽²⁾ ⁽³⁾ ⁽⁴⁾

PARAMETER		MIN	TYP	MAX	UNIT	
DIFFERENTIAL DRIVER CHARACTERISTICS						
t _{PHLD}	Differential Propagation Delay High to Low	R _L = 100Ω, C _L = 15 pF (Figure 16 and Figure 17)	0.3	0.8	2	ns
t _{PLHD}	Differential Propagation Delay Low to High		0.3	1.1	2	ns
t _{SKD1}	Differential Pulse Skew t _{PHLD} - t _{PLHD} ⁽⁵⁾		0	0.3	0.7	ns
t _{SKD2}	Channel to Channel Skew ⁽⁶⁾		0	0.4	0.8	ns
t _{SKD3}	Differential Part to Part Skew ⁽⁷⁾		0		1	ns
t _{SKD4}	Differential Part to Part Skew ⁽⁸⁾		0		1.2	ns
t _{TLH}	Transition Low to High Time		0.2	0.5	1	ns
t _{THL}	Transition High to Low Time		0.2	0.5	1	ns
f _{MAX}	Maximum Operating Frequency ⁽⁹⁾			350		MHz

- (1) All typicals are given for: V_{CC} = +3.3 V and T_A = +25°C.
- (2) These parameters are ensured by design. The limits are based on statistical analysis of the device over PVT (process, voltage, temperature) ranges.
- (3) C_L includes probe and fixture capacitance.
- (4) Generator waveform for all tests unless otherwise specified: f = 1 MHz, Z_O = 50Ω, t_r ≤ 1 ns, t_f ≤ 1 ns (10%-90%).
- (5) t_{SKD1}, |t_{PHLD} - t_{PLHD}|, is the magnitude difference in differential propagation delay time between the positive going edge and the negative going edge of the same channel.
- (6) t_{SKD2} is the Differential Channel to Channel Skew of any event on the same device.
- (7) t_{SKD3}, Differential Part to Part Skew, is defined as the difference between the minimum and maximum specified differential propagation delays. This specification applies to devices at the same V_{CC} and within 5°C of each other within the operating temperature range.
- (8) t_{SKD4}, part to part skew, is the differential channel to channel skew of any event between devices. This specification applies to devices over recommended operating temperature and voltage ranges, and across process distribution. t_{SKD4} is defined as |Max - Min| differential propagation delay.
- (9) f_{MAX} generator input conditions: t_r = t_f < 1 ns (0% to 100%), 50% duty cycle, 0V to 3V. Output criteria: duty cycle = 45%/55%, V_{OD} > 250mV, all channels switching.

6.7 Typical Characteristics

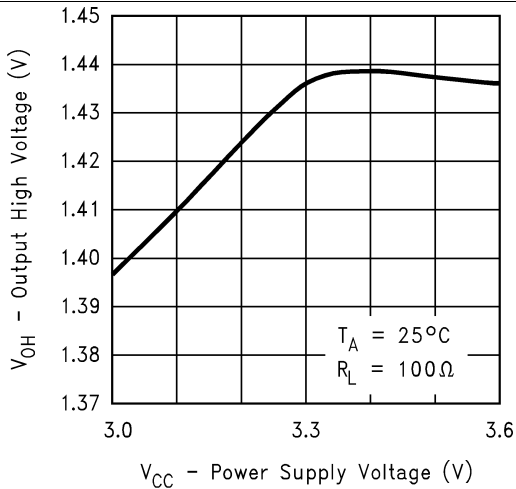

Figure 1. Output High Voltage vs Power Supply Voltage

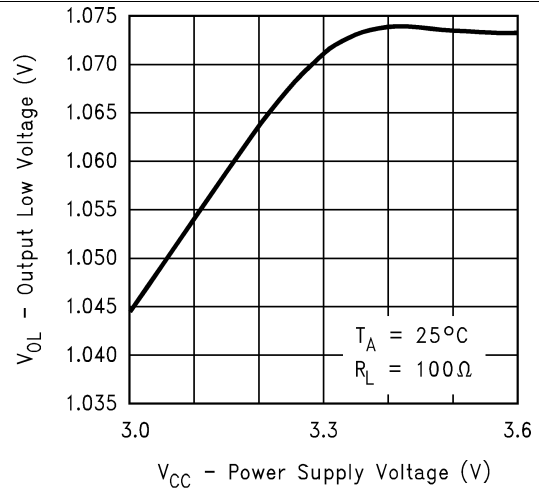

Figure 2. Output Low Voltage vs Power Supply Voltage

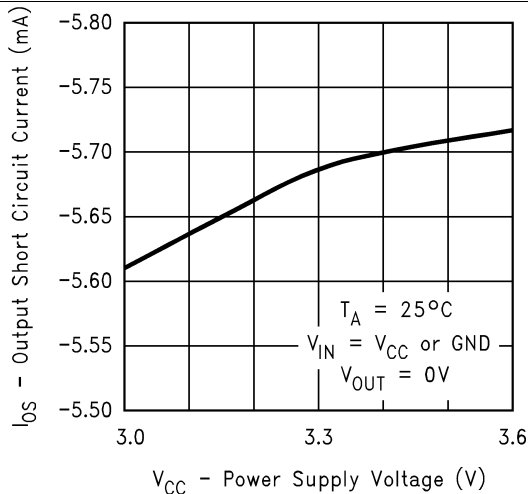

Figure 3. Output Short Circuit Current vs Power Supply Voltage

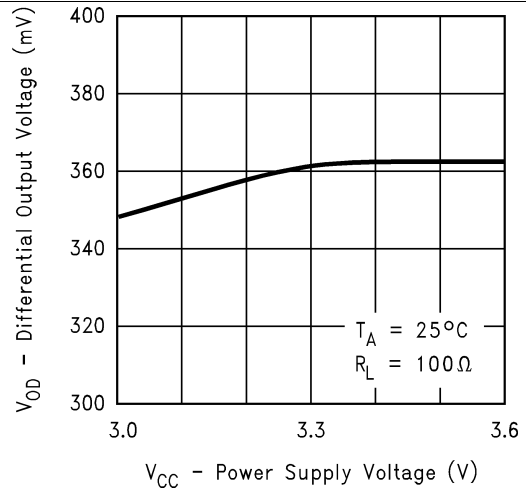

Figure 4. Differential Output Voltage vs Power Supply Voltage

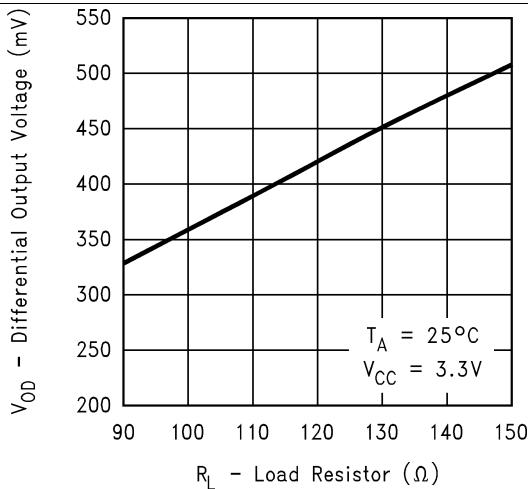

Figure 5. Differential Output Voltage vs Load Resistor

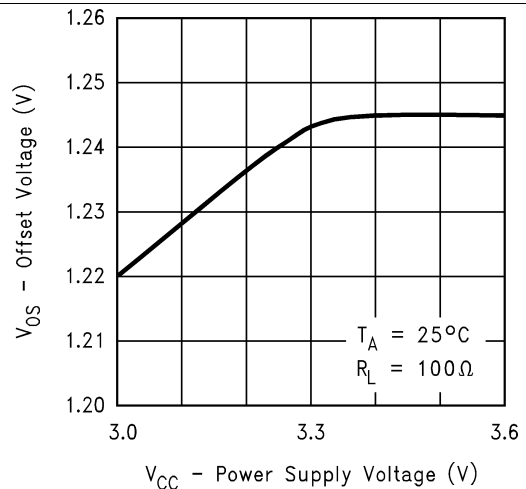

Figure 6. Offset Voltage vs Power Supply Voltage

Typical Characteristics (continued)

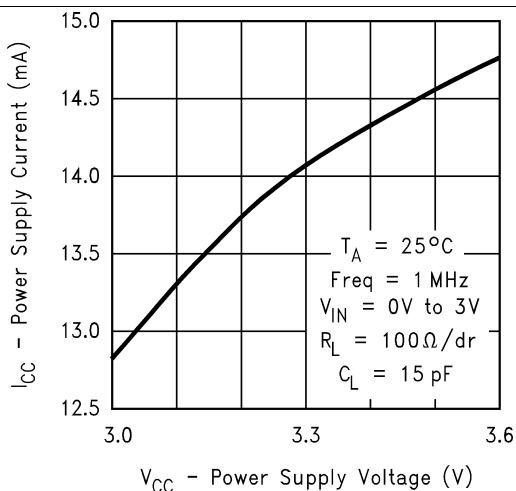

Figure 7. Power Supply Current vs Power Supply Voltage

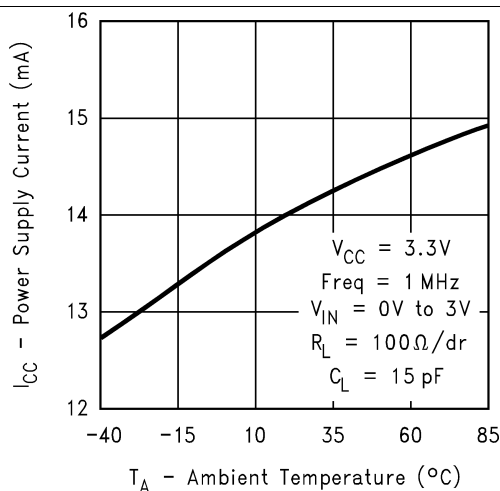

Figure 8. Power Supply Current vs Ambient Temperature

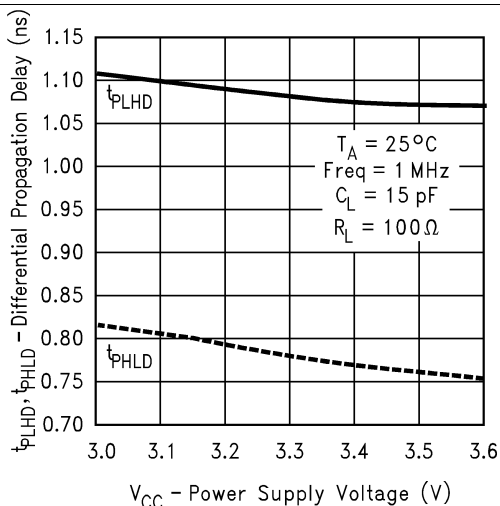

Figure 9. Differential Propagation Delay vs Power Supply Voltage

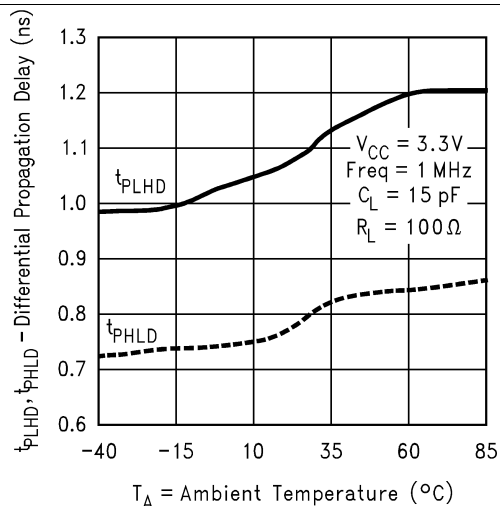

Figure 10. Differential Propagation Delay vs Ambient Temperature

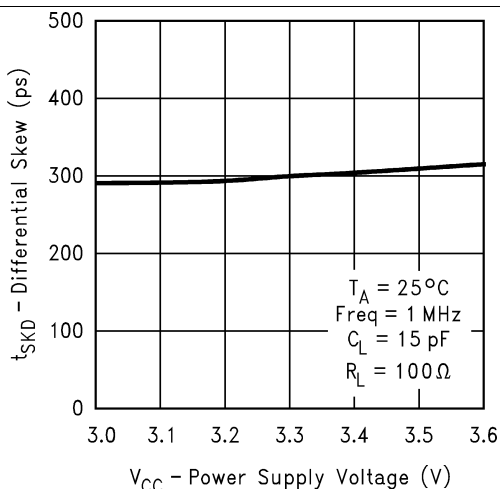

Figure 11. Differential Skew vs Power Supply Voltage

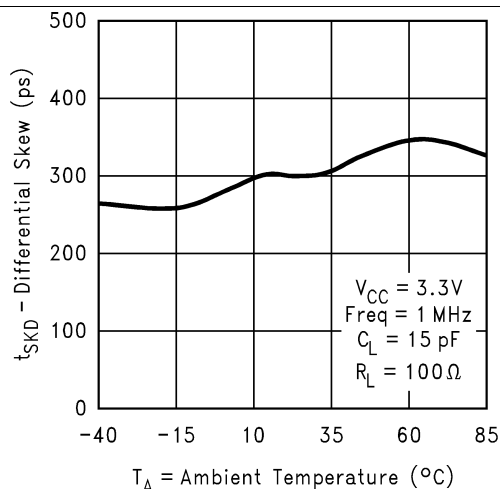
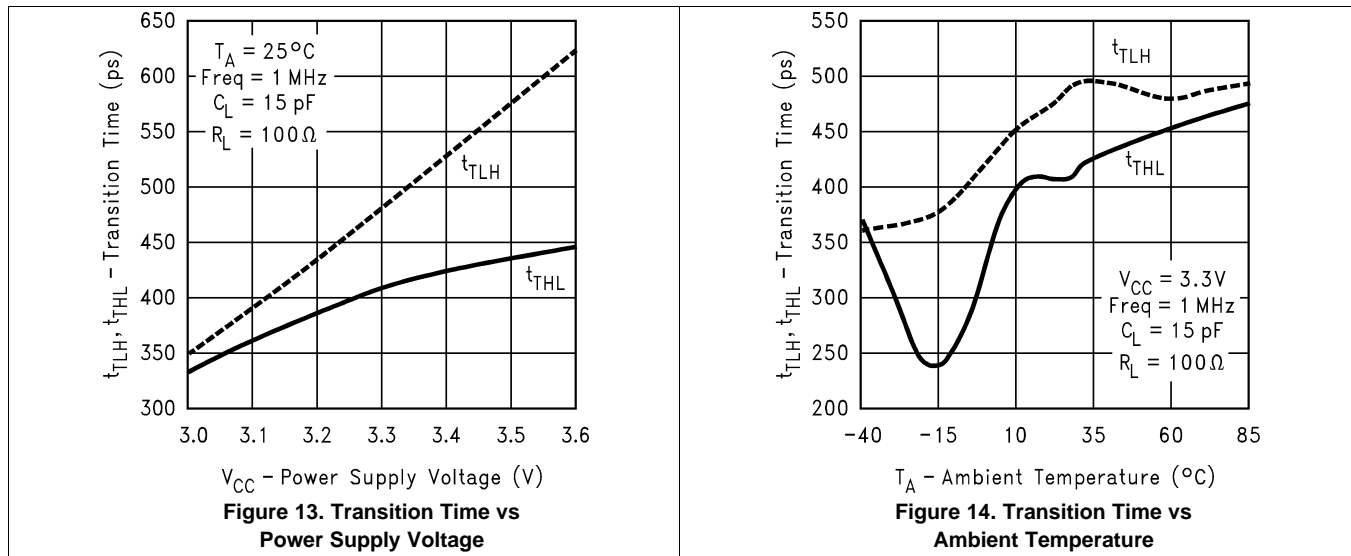

Figure 12. Differential Skew vs Ambient Temperature

Typical Characteristics (continued)

7 Parameter Measurement Information

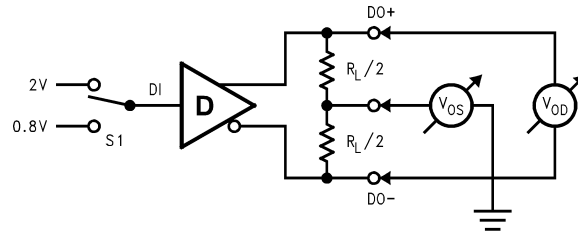

Figure 15. Differential Driver DC Test Circuit

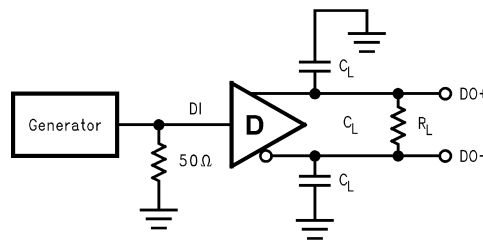

Figure 16. Differential Driver Propagation Delay and Transition Time Test Circuit

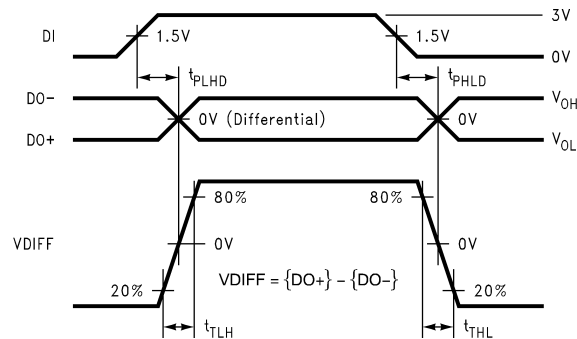

Figure 17. Differential Driver Propagation Delay and Transition Time Waveforms

8 Detailed Description

8.1 Overview

The DS90LV027AH is a dual-channel, low-voltage differential signaling (LVDS) line driver with a balanced current source design. It operates from a single power supply that is nominally 3.3 V, but the supply can be as low as 3.0 V and as high as 3.6 V. The input signal to the DS90LV027AH is an LVCMOS/LVTTL signal. The output of the device is a differential signal complying with the LVDS standard (TIA/EIA-644). The differential output signal operates with a signal level of 360 mV (nominally) at a common-mode voltage of 1.2 V. This low differential output voltage results in low electromagnetic interference (EMI). The differential nature of the output provides immunity to common-mode coupled signals that the driven signal may experience.

The DS90LV027AH is primarily used in point-to-point configurations, as seen in [Figure 20](#). This configuration provides a clean signaling environment for the fast edge rates of the DS90LV027AH and other LVDS drivers. The DS90LV027AH is connected through a balanced media which may be a standard twisted-pair cable, a parallel pair cable, or simply PCB traces to a LVDS receiver. Typically, the characteristic differential impedance of the media is in the range of 100 Ω. The DS90LV027AH device is intended to drive a 100-Ω transmission line. The 100-Ω termination resistor is selected to match the media and is placed as close to the LVDS receiver input pins as possible.

8.2 Functional Block Diagrams

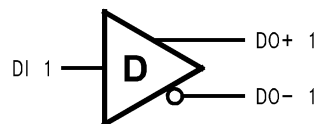

Figure 18. Functional Diagram of Channel 1

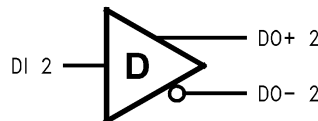

Figure 19. Functional Diagram of Channel 2

8.3 Feature Description

8.3.1 DS90LV027AH Driver Functionality

As can be seen in [Table 1](#), the driver single-ended input to differential output relationship is defined. When the driver input is left open, the differential output is undefined.

Table 1. DS90LV027AH Driver Functionality⁽¹⁾

INPUT	OUTPUTS	
	OUT +	OUT -
LVC MOS/LVTTL IN		
H	H	L
L	L	H
Open	?	?

(1) This table is valid for both Channel 1 and Channel 2 of this device.

8.3.2 Driver Output Voltage and Power-On Reset

The DS90LV027AH driver operates and meets all the specified performance requirements for supply voltages in the range of 3.0 V to 3.6 V. When the supply voltage drops below 1.5 V, or the voltage has not yet reached 1.5 V during turnon, the power-on reset circuitry will set the driver output to a high-impedance state.

8.3.3 Driver Offset

An LVDS-compliant driver is required to maintain the common-mode output voltage at 1.2 V (± 75 mV). The DS90LV027AH incorporates sense circuitry and a control loop to source common-mode current and keep the output signal within specified values. Further, the device maintains the output common-mode voltage at this set point over the full 3.0-V to 3.6-V supply range.

8.4 Device Functional Modes

The device has one mode of operation that applies when operated within the [Recommended Operating Conditions](#).

9 Application and Implementation

NOTE

Information in the following applications sections is not part of the TI component specification, and TI does not warrant its accuracy or completeness. TI's customers are responsible for determining suitability of components for their purposes. Customers should validate and test their design implementation to confirm system functionality.

9.1 Application Information

The DS90LV027AH device is a dual-channel LVDS driver. The functionality of this device is simple yet extremely flexible, leading to its use in designs ranging from wireless base stations to desktop computers. The DS90LV027AH has a flow-through pinout that allows for easy PCB layout. The LVDS signals on one side of the device allow easy matching of the electrical lengths for differential pair trace lines between the driver and the receiver, as well as allow trace lines to be close together to couple noise as common-mode. Noise isolation is achieved with the LVDS signals on one side of the device and the TTL signals on the other side.

9.2 Typical Application

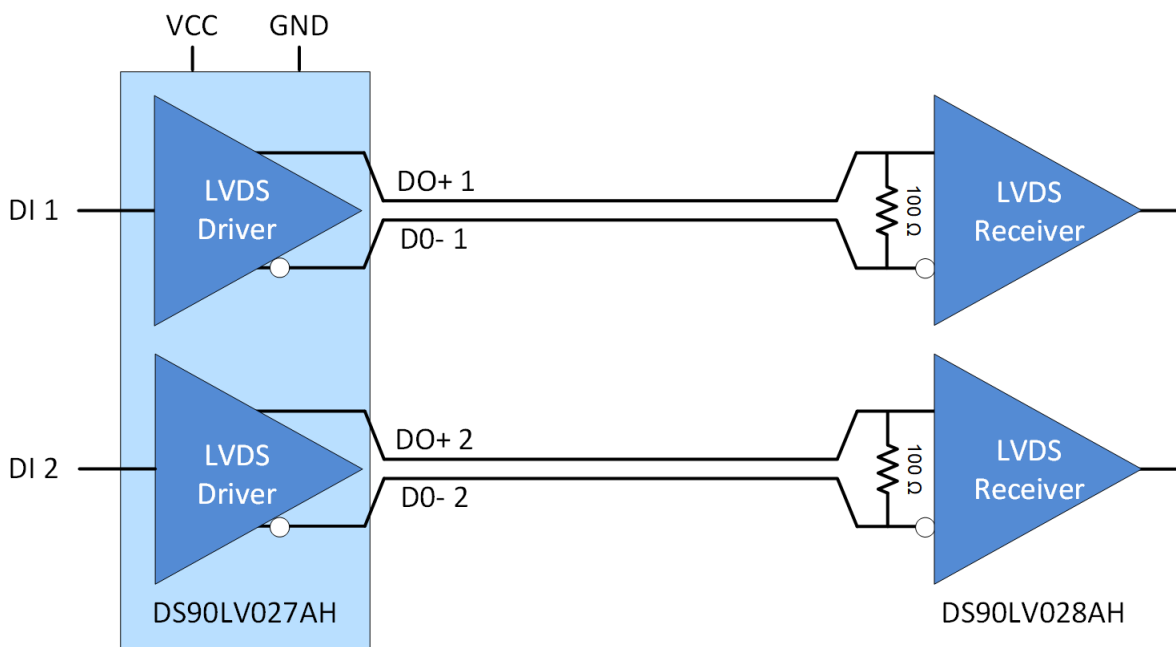

Figure 20. Point-to-Point Application

9.2.1 Design Requirements

Table 2 lists the design parameters as an example.

Table 2. Design Parameters

DESIGN PARAMETERS	EXAMPLE VALUE
Driver Supply Voltage (V_{DD})	3 to 3.6 V
Driver Input Voltage	0 to V_{DD}
Signaling Rate	0 to 600 Mbps
Interconnect Characteristic Impedance	100 Ω
Number of Receiver Nodes	2
Ground shift between driver and receiver	± 1 V

9.2.2 Detailed Design Procedure

9.2.2.1 Driver Supply Voltage

DS90LV027AH is a dual-channel LVDS driver that operates from a single supply. The device can support operation with a supply as low as 3.0 V and as high as 3.6 V. The driver output voltage is dependent upon the chosen supply voltage. The minimum output voltage stays within the specified LVDS limits (247 mV to 450 mV) for a 3.3-V supply. If the supply range is between 3.0 V and 3.6 V, the minimum output voltage may be as low as 150 mV. If a communication link is designed to operate with a supply within this lower range, the channel noise margin must be looked at carefully to ensure error-free operation.

9.2.2.2 Driver Bypass Capacitance

Bypass capacitors play a key role in power distribution circuitry. Specifically, they create low-impedance paths between power and ground. At low frequencies, a good digital power supply offers very low-impedance paths between its terminals. However, as higher frequency currents propagate through power traces, the source is quite often incapable of maintaining a low-impedance path to ground. Bypass capacitors are used to address this shortcoming. Usually, large bypass capacitors (10 μF to 1000 μF) at the board-level do a good job up into the kHz range. Due to their size and length of their leads, they tend to have large inductance values at the switching frequencies of modern digital circuitry. To solve this problem, one must resort to the use of smaller capacitors (nF to μF range) installed locally next to the integrated circuit.

Multilayer ceramic chip or surface-mount capacitors (size 0603 or 0805) minimize lead inductances of bypass capacitors in high-speed environments, because their lead inductance is about 1 nH. For comparison purposes, a typical capacitor with leads has a lead inductance around 5 nH.

The value of the bypass capacitors used locally with LVDS chips can be determined by [Equation 1](#) and [Equation 2](#), according to Johnson⁽¹⁾ equations 8.18 to 8.21. A conservative rise time of 200 ps and a worst-case change in supply current of 1 A covers the whole range of LVDS devices offered by Texas Instruments. In this example, the maximum power supply noise tolerated is 200 mV. However, this figure varies depending on the noise budget available in the design. ⁽¹⁾

$$C_{\text{chip}} = \left(\frac{\Delta I_{\text{Maximum Step Change Supply Current}}}{\Delta V_{\text{Maximum Power Supply Noise}}} \right) \times T_{\text{Rise Time}} \quad (1)$$

$$C_{\text{LVDS}} = \left(\frac{1\text{A}}{0.2\text{V}} \right) \times 200 \text{ ps} = 0.001 \mu\text{F} \quad (2)$$

[Figure 21](#) lowers lead inductance and covers intermediate frequencies between the board-level capacitor (>10 μF) and the value of capacitance found above (0.001 μF). TI recommends to place the smallest value of capacitance as close to the chip as possible.

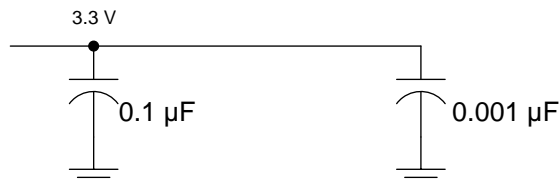

Figure 21. Recommended LVDS Bypass Capacitor Layout

9.2.2.3 Driver Input Voltage

The DS90LV027AH single-ended input is designed to support a wide input voltage range. The input stage can accept signals as high as 3.6 V when the supply voltage is 3.6 V.

(1) Howard Johnson & Martin Graham. 1993. High Speed Digital Design – A Handbook of Black Magic. Prentice Hall PRT. ISBN number 013395724.

9.2.2.4 Driver Output Voltage

DS90LV027AH driver output has a 1.2-V common-mode voltage, with a nominal differential output signal of 360 mV. This 360 mV is the absolute value of the differential swing ($VOD = |V+ - V-|$). The peak-to-peak differential voltage is either twice this value or 700 mV. LVDS receiver thresholds are ± 100 mV. With these receiver decision thresholds, it is clear that the disadvantage of operating the driver with a lower supply will be noise margin. With fully-compliant LVDS drivers and receivers, the user could expect a minimum of approximately 150 mV of noise margin (247-mV minimum output voltage – 100-mV maximum input requirement). If the DS90LV027AH operates under a supply range of 3.0 V to 3.6 V, the minimum noise margin will drop to 150 mV.

9.2.2.5 Interconnecting Media

The physical communication channel between the LVDS driver and LVDS receiver may be any balanced and paired metal conductors meeting the requirements of the LVDS standard, the key points of which are included here. This media may be a twisted-pair, twinax, flat ribbon cable, or PCB traces. The nominal characteristic impedance of the interconnect media should be between 100 Ω and 120 Ω with a variation of no more than 10% (90 Ω to 132 Ω).

9.2.2.6 PCB Transmission Lines

As per the *LVDS Owner's Manual Design Guide, 4th Edition* (SNLA187), [Figure 22](#) depicts several transmission line structures commonly used in printed-circuit boards (PCBs). Each structure consists of a signal line and return path with a uniform cross section along its length. A microstrip is a signal trace on the top (or bottom) layer, separated by a dielectric layer from its return path in a ground or power plane. A stripline is a signal trace in the inner layer, with a dielectric layer in between a ground plane above and below the signal trace. The dimensions of the structure along with the dielectric material properties determine the characteristic impedance of the transmission line (also called controlled-impedance transmission line).

When two signal lines are placed close by, they form a pair of coupled transmission lines. [Figure 22](#) shows examples of edge-coupled microstrip lines, and edge-coupled or broad-side-coupled striplines. When excited by differential signals, the coupled transmission line is referred to as a differential pair. The characteristic impedance of each line is called odd-mode impedance. The sum of the odd-mode impedances of each line is the differential impedance of the differential pair. In addition to the trace dimensions and dielectric material properties, the spacing between the two traces determines the mutual coupling and impacts the differential impedance. When the two lines are immediately adjacent (like if S is less than $2W$, for example), the differential pair is called a tightly-coupled differential pair. To maintain constant differential impedance along the length, it is important to keep the trace width and spacing uniform along the length, as well as maintain good symmetry between the two lines.

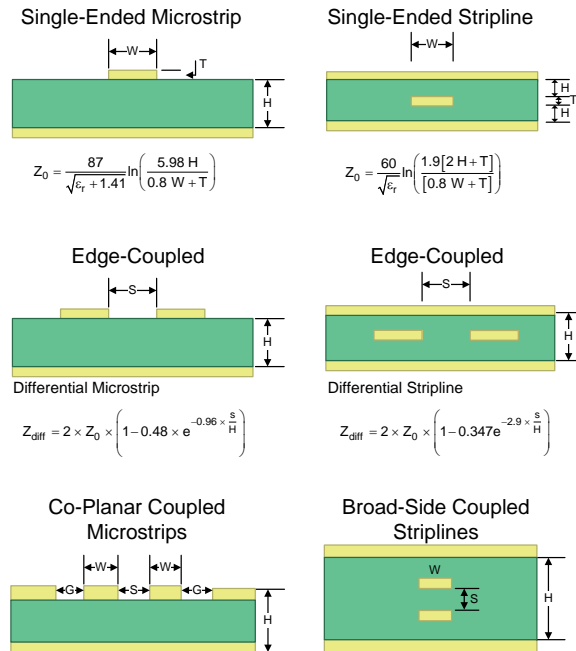

Figure 22. Controlled-Impedance Transmission Lines

9.2.3 Termination Resistor

As shown earlier, an LVDS communication channel employs a current source driving a transmission line that is terminated with a resistive load. This load serves to convert the transmitted current into a voltage at the receiver input. To ensure incident wave switching (which is necessary to operate the channel at the highest signaling rate), the termination resistance should be matched to the characteristic impedance of the transmission line. The designer should ensure that the termination resistance is within 10% of the nominal media characteristic impedance. If the transmission line is targeted for 100-Ω impedance, the termination resistance should be between 90 Ω and 110 Ω. The line termination resistance should be placed as close to the receiver as possible to minimize the stub length from the resistor to the receiver.

9.2.4 Application Curve

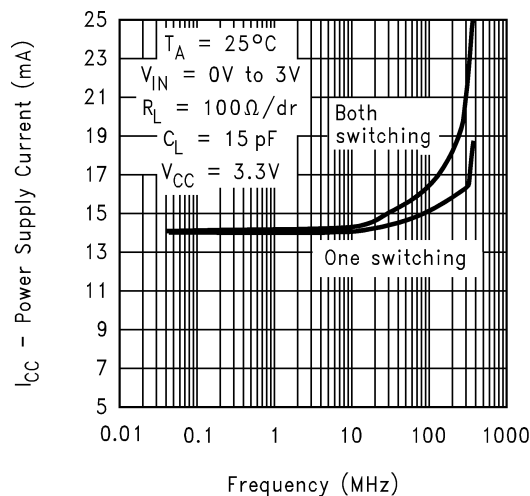

Figure 23. Power Supply Current vs Frequency

10 Power Supply Recommendations

The DS90LV027AH driver is designed to operate from a single power supply with supply voltage in the range of 3.0 V to 3.6 V. In a typical application, a driver and a receiver may be on separate boards, or even separate equipment. In these cases, separate supplies would be used at each location. The expected ground potential difference between the driver power supply and the driver power supply would be less than $|\pm 1\text{ V}|$. Board level and local device level bypass capacitance should be used.

11 Layout

11.1 Layout Guidelines

11.1.1 Microstrip vs. Stripline Topologies

As per the *LVDS Application and Data Handbook* (SLLD009), printed-circuit boards usually offer designers two transmission line options: Microstrip and stripline. Microstrips are traces on the outer layer of a PCB, as shown in Figure 24.

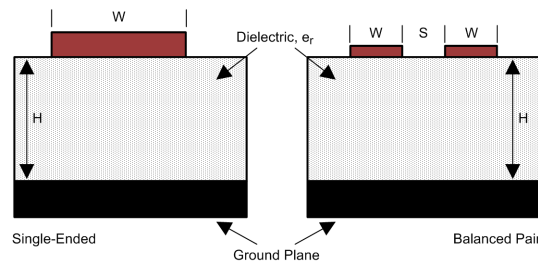

Figure 24. Microstrip Topology

On the other hand, striplines are traces between two ground planes. Striplines are less prone to emissions and susceptibility problems because the reference planes effectively shield the embedded traces. However, from the standpoint of high-speed transmission, juxtaposing two planes creates additional capacitance. TI recommends routing LVDS signals on microstrip transmission lines when possible. The PCB traces allow designers to specify the necessary tolerances for Z_O based on the overall noise budget and reflection allowances. Footnotes 1⁽²⁾, 2⁽³⁾, and 3⁽⁴⁾ provide formulas for Z_O and t_{PD} for differential and single-ended traces. ⁽²⁾ ⁽³⁾ ⁽⁴⁾

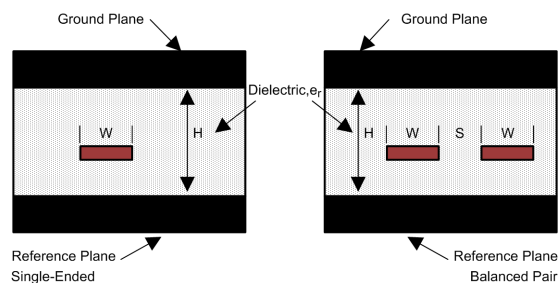

Figure 25. Stripline Topology

(2) Howard Johnson & Martin Graham. 1993. *High Speed Digital Design – A Handbook of Black Magic*. Prentice Hall PRT. ISBN number 013395724.

(3) Mark I. Montrose. 1996. *Printed Circuit Board Design Techniques for EMC Compliance*. IEEE Press. ISBN number 0780311310.

(4) Clyde F. Coombs, Jr. Ed, *Printed Circuits Handbook*, McGraw Hill, ISBN number 0070127549.

Layout Guidelines (continued)

11.1.2 Dielectric Type and Board Construction

The speeds at which signals travel across the board dictates the choice of dielectric. FR-4, or an equivalent, usually provides adequate performance for use with LVDS signals. If rise or fall times of LVCMOS/LVTTL signals are less than 500 ps, empirical results indicate that a material with a dielectric constant near 3.4, such as Rogers™ 4350 or Nelco N4000-13, may be desired. Once the designer chooses the dielectric, there are several parameters pertaining to the board construction that can affect performance. The following set of guidelines were developed experimentally through several designs involving LVDS devices:

- Copper weight: 15 g or 1/2 oz start, plated to 30 g or 1 oz
- All exposed circuitry should be solder-plated (60/40) to 7.62 μm or 0.0003 in (minimum).
- Copper plating should be 25.4 μm or 0.001 in (minimum) in plated-through-holes.
- Solder mask over bare copper with solder hot-air leveling

11.1.3 Recommended Stack Layout

Following the choice of dielectrics and design specifications, the designer must decide how many levels to use in the stack. To reduce the LVCMOS/LVTTL to LVDS crosstalk, it is good practice to have at least two separate signal planes as shown in [Figure 26](#).

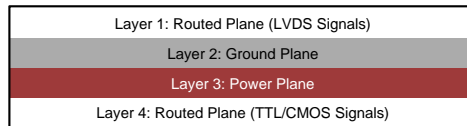

Figure 26. Four-Layer PCB

NOTE

The separation between layers 2 and 3 should be 127 μm (0.005 in). By keeping the power and ground planes tightly coupled, the increased capacitance acts as a bypass for transients.

One of the most common stack configurations is the six-layer board, as shown in [Figure 27](#).

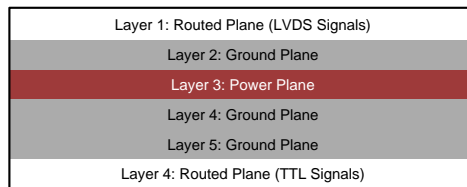

Figure 27. Six-Layer PCB

In this particular configuration, it is possible to isolate each signal layer from the power plane by at least one ground plane. The result is improved signal integrity, but fabrication is more expensive. Using the 6-layer board is preferable, because it offers the layout designer more flexibility in varying the distance between signal layers and referenced planes in addition to ensuring reference to a ground plane for signal layers 1 and 6.

11.1.4 Separation Between Traces

The separation between traces depends on several factors, but the amount of coupling that can be tolerated usually dictates the actual separation. Low-noise coupling requires close coupling between the differential pair of an LVDS link to benefit from the electromagnetic field cancellation. The traces should be 100- Ω differential and thus coupled in the manner that best fits this requirement. In addition, differential pairs should have the same electrical length to ensure that they are balanced, thus minimizing problems with skew and signal reflection.

Layout Guidelines (continued)

In the case of two adjacent single-ended traces, one should use the 3-W rule, which stipulates that the distance between two traces must be greater than two times the width of a single trace, or three times its width measured from trace center to trace center. This increased separation effectively reduces the potential for crosstalk. The same rule should be applied to the separation between adjacent LVDS differential pairs, whether the traces are edge-coupled or broad-side-coupled.

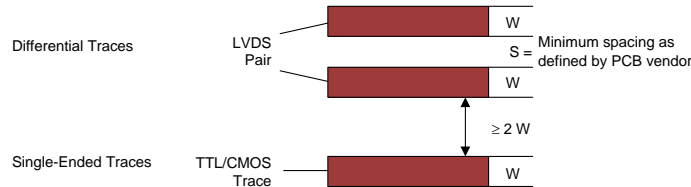

Figure 28. 3-W Rule for Single-Ended and Differential Traces (Top View)

Exercise caution when using autorouters, because they do not always account for all factors affecting crosstalk and signal reflection. For instance, it is best to avoid sharp 90° turns to prevent discontinuities in the signal path. Using successive 45° turns tends to minimize reflections.

11.1.5 Crosstalk and Ground Bounce Minimization

To reduce crosstalk, it is important to provide a return path to high-frequency currents that is as close to its originating trace as possible. A ground plane usually achieves this. Because the returning currents always choose the path of lowest inductance, they are most likely to return directly under the original trace, thus minimizing crosstalk. Lowering the area of the current loop lowers the potential for crosstalk. Traces kept as short as possible with an uninterrupted ground plane running beneath them emit the minimum amount of electromagnetic field strength. Discontinuities in the ground plane increase the return path inductance and should be avoided.

11.1.6 Decoupling

Each power or ground lead of a high-speed device should be connected to the PCB through a low inductance path. For best results, one or more vias are used to connect a power or ground pin to the nearby plane. TI recommends that the user place a via immediately adjacent to the pin to avoid adding trace inductance. Placing a power plane closer to the top of the board reduces the effective via length and its associated inductance.

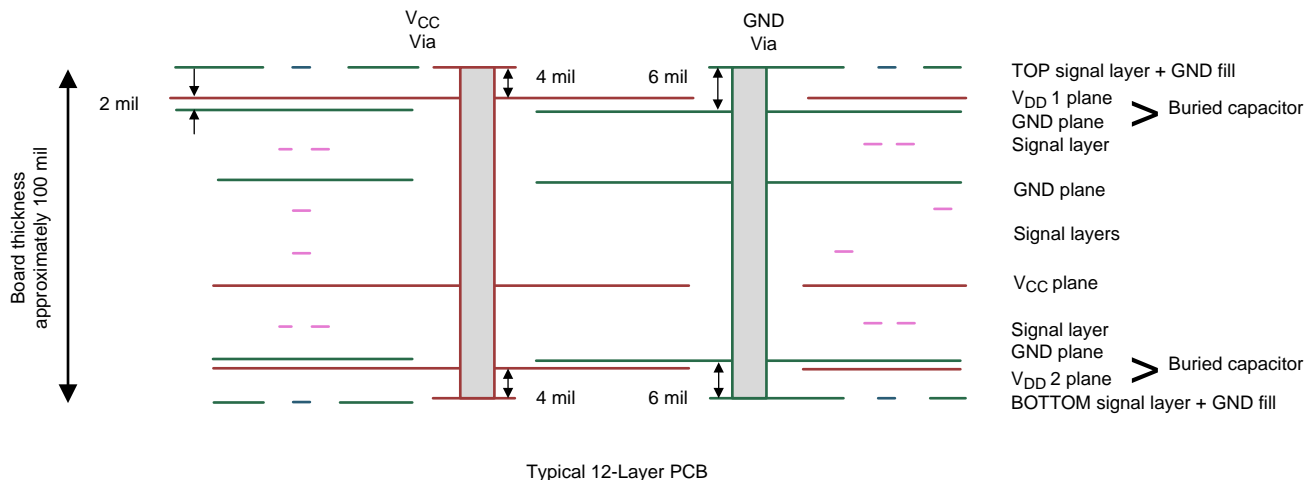

Figure 29. Low Inductance, High-Capacitance Power Connection

Layout Guidelines (continued)

Bypass capacitors should be placed close to V_{DD} pins. They can be placed conveniently near the corners or underneath the package to minimize the loop area. This extends the useful frequency range of the added capacitance. Small-physical-size capacitors, such as 0402 or even 0201, or X7R surface-mount capacitors should be used to minimize body inductance of capacitors. Each bypass capacitor is connected to the power and ground plane through vias tangent to the pads of the capacitor as shown in Figure 30(a).

An X7R surface-mount capacitor of size 0402 has about 0.5 nH of body inductance. At frequencies above 30 MHz or so, X7R capacitors behave as low-impedance inductors. To extend the operating frequency range to a few hundred MHz, an array of different capacitor values like 100 pF, 1 nF, 0.03 μ F, and 0.1 μ F are commonly used in parallel. The most effective bypass capacitor can be built using sandwiched layers of power and ground at a separation of 2 to 3 mils. With a 2-mil FR4 dielectric, there is approximately 500 pF per square inch of PCB. Refer back to Figure 22 for some examples. Many high-speed devices provide a low-inductance GND connection on the backside of the package. This center dap must be connected to a ground plane through an array of vias. The via array reduces the effective inductance to ground and enhances the thermal performance of the small Surface Mount Technology (SMT) package. Placing vias around the perimeter of the dap connection ensures proper heat spreading and the lowest possible die temperature. Placing high-performance devices on opposing sides of the PCB using two GND planes (as shown in Figure 22) creates multiple paths for heat transfer. Often thermal PCB issues are the result of one device adding heat to another, resulting in a very high local temperature. Multiple paths for heat transfer minimize this possibility. In many cases the GND dap that is so important for heat dissipation makes the optimal decoupling layout impossible to achieve due to insufficient pad-to-dap spacing as shown in Figure 30(b). When this occurs, placing the decoupling capacitor on the backside of the board keeps the extra inductance to a minimum. It is important to place the V_{DD} via as close to the device pin as possible while still allowing for sufficient solder mask coverage. If the via is left open, solder may flow from the pad and into the via barrel. This will result in a poor solder connection.



Figure 30. Typical Decoupling Capacitor Layouts

At least two or three times the width of an individual trace should separate single-ended traces and differential pairs to minimize the potential for crosstalk. Single-ended traces that run in parallel for less than the wavelength of the rise or fall times usually have negligible crosstalk. Increase the spacing between signal paths for long parallel runs to reduce crosstalk. Boards with limited real estate can benefit from the staggered trace layout, as shown in Figure 31.

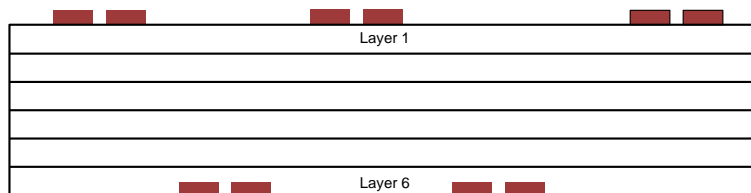

Figure 31. Staggered Trace Layout

This configuration lays out alternating signal traces on different layers. Thus, the horizontal separation between traces can be less than 2 or 3 times the width of individual traces. To ensure continuity in the ground signal path, TI recommends having an adjacent ground via for every signal via, as shown in Figure 32. Note that vias create additional capacitance. For example, a typical via has a lumped capacitance effect of 1/2 pF to 1 pF in FR4.

Layout Guidelines (continued)

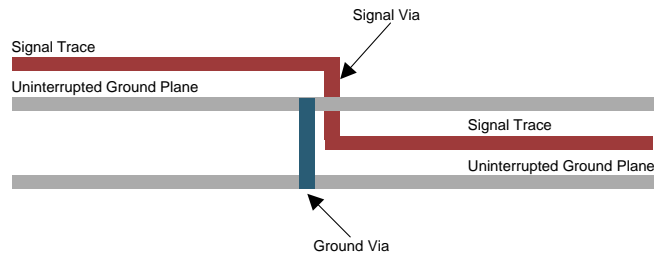

Figure 32. Ground Via Location (Side View)

Short and low-impedance connection of the device ground pins to the PCB ground plane reduces ground bounce. Holes and cutouts in the ground planes can adversely affect current return paths if they create discontinuities that increase returning current loop areas.

To minimize EMI problems, TI recommends avoiding discontinuities below a trace (for example, holes, slits, and so on) and keeping traces as short as possible. Zoning the board wisely by placing all similar functions in the same area, as opposed to mixing them together, helps reduce susceptibility issues.

11.2 Layout Example

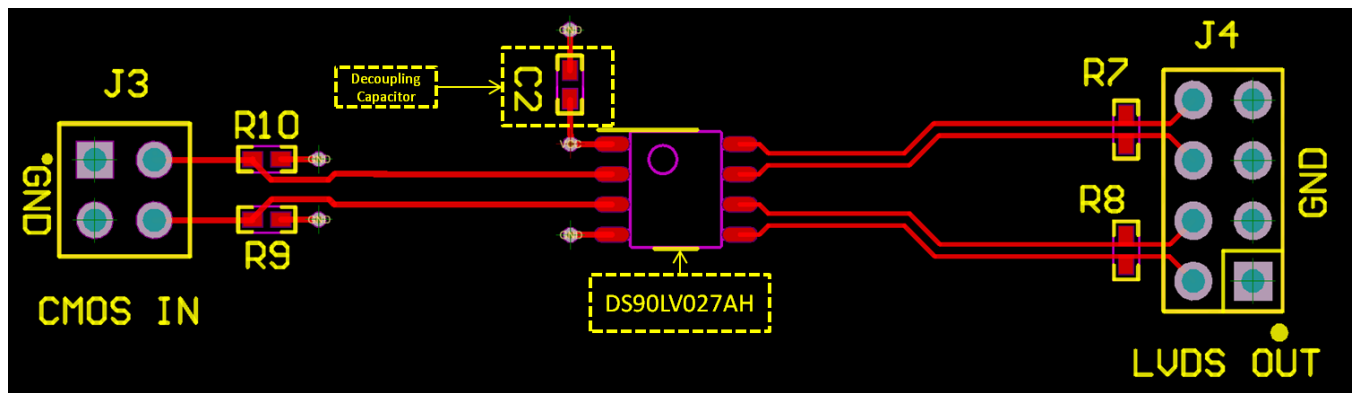

Figure 33. Example DS90LV027AH Layout

12 器件和文档支持

12.1 相关文档

请参阅如下相关文档：

- 《LVDS 用户手册》(SNLA187)
- 《AN-808 长距离传输线路和数据信号质量》(SNLA028)
- 《AN-977 LVDS 信号质量：使用眼图测量抖动测试报告 #1》(SNLA166)
- 《AN-971 LVDS 技术概览》(SNLA165)
- 《AN-916 电缆选择实用指南》(SNLA219)
- 《AN-805 差分线路驱动器功耗计算》(SNOA233)
- 《AN-903 差分终端技巧对比》(SNLA034)
- 《LVDS 接口的 AN-1194 失效防护偏置》(SNLA051)

12.2 接收文档更新通知

要接收文档更新通知，请导航至 TI.com.cn 上的器件产品文件夹。单击右上角的 *通知我* 进行注册，即可每周接收产品信息更改摘要。有关更改的详细信息，请查看任何已修订文档中包含的修订历史记录。

12.3 社区资源

下列链接提供到 TI 社区资源的连接。链接的内容由各个分销商“按照原样”提供。这些内容并不构成 TI 技术规范，并且不一定反映 TI 的观点；请参阅 TI 的《使用条款》。

TI E2E™ 在线社区 *TI 的工程师对工程师 (E2E) 社区*。此社区的创建目的在于促进工程师之间的协作。在 e2e.ti.com 中，您可以咨询问题、分享知识、拓展思路并与同行工程师一道帮助解决问题。

设计支持 *TI 参考设计支持* 可帮助您快速查找有帮助的 E2E 论坛、设计支持工具以及技术支持的联系信息。

12.4 商标

E2E is a trademark of Texas Instruments.
 Rogers is a trademark of Rogers Corporation.
 All other trademarks are the property of their respective owners.

12.5 静电放电警告



ESD 可能会损坏该集成电路。德州仪器 (TI) 建议通过适当的预防措施处理所有集成电路。如果不遵守正确的处理措施和安装程序，可能会损坏集成电路。

ESD 的损坏小至导致微小的性能降级，大至整个器件故障。精密的集成电路可能更容易受到损坏，这是因为非常细微的参数更改都可能会导致器件与其发布的规格不相符。

12.6 术语表



SLYZ022 — *TI 术语表*。

这份术语表列出并解释术语、缩写和定义。

13 机械、封装和可订购信息

以下页面包含机械、封装和可订购信息。这些信息是指定器件的最新可用数据。数据如有变更，恕不另行通知，且不会对此文档进行修订。如需获取此数据表的浏览器版本，请查阅左侧的导航栏。

PACKAGING INFORMATION

Orderable Device	Status (1)	Package Type	Package Drawing	Pins	Package Qty	Eco Plan (2)	Lead finish/ Ball material (6)	MSL Peak Temp (3)	Op Temp (°C)	Device Marking (4/5)	Samples
DS90LV027AHM/NOPB	ACTIVE	SOIC	D	8	95	RoHS & Green	SN	Level-1-260C-UNLIM	-40 to 125	LV27A HM	
DS90LV027AHMX/NOPB	ACTIVE	SOIC	D	8	2500	RoHS & Green	SN	Level-1-260C-UNLIM	-40 to 125	LV27A HM	

(1) The marketing status values are defined as follows:

ACTIVE: Product device recommended for new designs.

LIFEBUY: TI has announced that the device will be discontinued, and a lifetime-buy period is in effect.

NRND: Not recommended for new designs. Device is in production to support existing customers, but TI does not recommend using this part in a new design.

PREVIEW: Device has been announced but is not in production. Samples may or may not be available.

OBSOLETE: TI has discontinued the production of the device.

(2) **RoHS:** TI defines "RoHS" to mean semiconductor products that are compliant with the current EU RoHS requirements for all 10 RoHS substances, including the requirement that RoHS substance do not exceed 0.1% by weight in homogeneous materials. Where designed to be soldered at high temperatures, "RoHS" products are suitable for use in specified lead-free processes. TI may reference these types of products as "Pb-Free".

RoHS Exempt: TI defines "RoHS Exempt" to mean products that contain lead but are compliant with EU RoHS pursuant to a specific EU RoHS exemption.

Green: TI defines "Green" to mean the content of Chlorine (Cl) and Bromine (Br) based flame retardants meet JS709B low halogen requirements of <=1000ppm threshold. Antimony trioxide based flame retardants must also meet the <=1000ppm threshold requirement.

(3) MSL, Peak Temp. - The Moisture Sensitivity Level rating according to the JEDEC industry standard classifications, and peak solder temperature.

(4) There may be additional marking, which relates to the logo, the lot trace code information, or the environmental category on the device.

(5) Multiple Device Markings will be inside parentheses. Only one Device Marking contained in parentheses and separated by a "~" will appear on a device. If a line is indented then it is a continuation of the previous line and the two combined represent the entire Device Marking for that device.

(6) Lead finish/Ball material - Orderable Devices may have multiple material finish options. Finish options are separated by a vertical ruled line. Lead finish/Ball material values may wrap to two lines if the finish value exceeds the maximum column width.

Important Information and Disclaimer: The information provided on this page represents TI's knowledge and belief as of the date that it is provided. TI bases its knowledge and belief on information provided by third parties, and makes no representation or warranty as to the accuracy of such information. Efforts are underway to better integrate information from third parties. TI has taken and continues to take reasonable steps to provide representative and accurate information but may not have conducted destructive testing or chemical analysis on incoming materials and chemicals. TI and TI suppliers consider certain information to be proprietary, and thus CAS numbers and other limited information may not be available for release.

In no event shall TI's liability arising out of such information exceed the total purchase price of the TI part(s) at issue in this document sold by TI to Customer on an annual basis.

TAPE AND REEL INFORMATION

QUADRANT ASSIGNMENTS FOR PIN 1 ORIENTATION IN TAPE

*All dimensions are nominal

Device	Package Type	Package Drawing	Pins	SPQ	Reel Diameter (mm)	Reel Width W1 (mm)	A0 (mm)	B0 (mm)	K0 (mm)	P1 (mm)	W (mm)	Pin1 Quadrant
DS90LV027AHMX/NOPB	SOIC	D	8	2500	330.0	12.4	6.5	5.4	2.0	8.0	12.0	Q1

TAPE AND REEL BOX DIMENSIONS

*All dimensions are nominal

Device	Package Type	Package Drawing	Pins	SPQ	Length (mm)	Width (mm)	Height (mm)
DS90LV027AHMX/NOPB	SOIC	D	8	2500	367.0	367.0	35.0

TUBE

*All dimensions are nominal

Device	Package Name	Package Type	Pins	SPQ	L (mm)	W (mm)	T (μm)	B (mm)
DS90LV027AHM/NOPB	D	SOIC	8	95	495	8	4064	3.05



D0008A

PACKAGE OUTLINE

SOIC - 1.75 mm max height

SMALL OUTLINE INTEGRATED CIRCUIT



4214825/C 02/2019

NOTES:

1. Linear dimensions are in inches [millimeters]. Dimensions in parenthesis are for reference only. Controlling dimensions are in inches. Dimensioning and tolerancing per ASME Y14.5M.
2. This drawing is subject to change without notice.
3. This dimension does not include mold flash, protrusions, or gate burrs. Mold flash, protrusions, or gate burrs shall not exceed .006 [0.15] per side.
4. This dimension does not include interlead flash.
5. Reference JEDEC registration MS-012, variation AA.

EXAMPLE BOARD LAYOUT

D0008A

SOIC - 1.75 mm max height

SMALL OUTLINE INTEGRATED CIRCUIT



LAND PATTERN EXAMPLE
 EXPOSED METAL SHOWN
 SCALE:8X



SOLDER MASK DETAILS

4214825/C 02/2019

NOTES: (continued)

- 6. Publication IPC-7351 may have alternate designs.
- 7. Solder mask tolerances between and around signal pads can vary based on board fabrication site.

EXAMPLE STENCIL DESIGN

D0008A

SOIC - 1.75 mm max height

SMALL OUTLINE INTEGRATED CIRCUIT



SOLDER PASTE EXAMPLE
BASED ON .005 INCH [0.125 MM] THICK STENCIL
SCALE:8X

4214825/C 02/2019

NOTES: (continued)

8. Laser cutting apertures with trapezoidal walls and rounded corners may offer better paste release. IPC-7525 may have alternate design recommendations.
9. Board assembly site may have different recommendations for stencil design.

重要声明和免责声明

TI“按原样”提供技术和可靠性数据（包括数据表）、设计资源（包括参考设计）、应用或其他设计建议、网络工具、安全信息和其他资源，不保证没有瑕疵且不做任何明示或暗示的担保，包括但不限于对适销性、某特定用途方面的适用性或不侵犯任何第三方知识产权的暗示担保。

这些资源可供使用 TI 产品进行设计的熟练开发人员使用。您将自行承担以下全部责任：(1) 针对您的应用选择合适的 TI 产品，(2) 设计、验证并测试您的应用，(3) 确保您的应用满足相应标准以及任何其他功能安全、信息安全、监管或其他要求。

这些资源如有变更，恕不另行通知。TI 授权您仅可将这些资源用于研发本资源所述的 TI 产品的应用。严禁对这些资源进行其他复制或展示。您无权使用任何其他 TI 知识产权或任何第三方知识产权。您应全额赔偿因在这些资源的使用中对 TI 及其代表造成的任何索赔、损害、成本、损失和债务，TI 对此概不负责。

TI 提供的产品受 [TI 的销售条款](#) 或 [ti.com](#) 上其他适用条款/TI 产品随附的其他适用条款的约束。TI 提供这些资源并不会扩展或以其他方式更改 TI 针对 TI 产品发布的适用的担保或担保免责声明。

TI 反对并拒绝您可能提出的任何其他或不同的条款。

邮寄地址：Texas Instruments, Post Office Box 655303, Dallas, Texas 75265

Copyright © 2022，德州仪器 (TI) 公司