

DS90LV028A-Q1 Automotive LVDS Dual Differential Line Receiver

1 Features

- AEC-Q100 qualified for automotive applications
 - Temperature grade 2: -40°C to +105°C
- >400 Mbps (200 MHz) switching rates
- 50 ps differential skew (typical)
- 0.1 ns channel-to-channel skew (typical)
- 2.5 ns maximum propagation delay
- 3.3 V power supply design
- Flow-through pinout
- Power down high impedance on LVDS inputs
- Low power design (18 mW at 3.3 V static)
- LVDS inputs accept LVDS/CML/LVPECL signals
- Conforms to ANSI/TIA/EIA-644 standard

2 Applications

- [Electronic point of sale \(EPOS\) applications](#)
- [Automotive infotainment and cluster](#)
- [Automotive head unit](#)

3 Description

The DS90LV028A-Q1 is a dual CMOS differential line receiver designed for applications requiring ultra low power dissipation, low noise and high data rates. The device is designed to support data rates in excess of 400 Mbps (200 MHz) utilizing Low Voltage Differential Signaling (LVDS) technology.

The DS90LV028A-Q1 accepts low voltage (350 mV typical) differential input signals and translates them to 3 V CMOS output levels. The DS90LV028A-Q1 has a flow-through design for easy PCB layout.

The DS90LV028A-Q1 and companion LVDS line driver DS90LV027AQ provide a new alternative to high power PECL/ECL devices for high speed point-to-point interface applications.

Device Information (1)

PART NUMBER	PACKAGE	BODY SIZE (NOM)
DS90LV028A-Q1	WSON (DQF 8)	2.00 mm x 2.00 mm

(1) For all available packages, see the orderable addendum at the end of the data sheet.

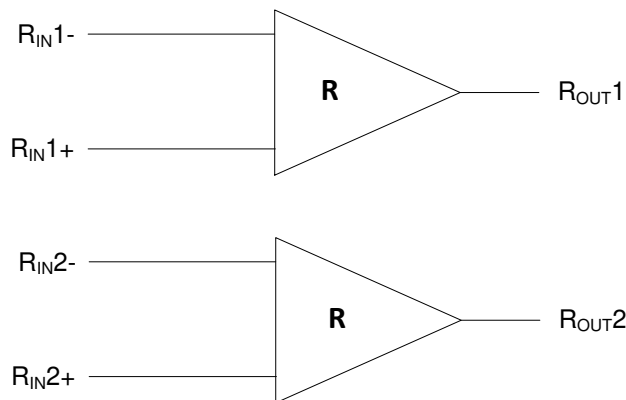

Functional Diagram



Table of Contents

1 Features	1	8.3 Feature Description.....	10
2 Applications	1	8.4 Device Functional Modes.....	10
3 Description	1	9 Application and Implementation	11
4 Revision History	2	9.1 Application Information.....	11
5 Pin Configuration and Functions	3	9.2 Typical Application.....	11
6 Specifications	4	10 Power Supply Recommendations	13
6.1 Absolute Maximum Ratings.....	4	11 Layout	14
6.2 ESD and Latch-Up Ratings.....	4	11.1 Layout Guidelines.....	14
6.3 Recommended Operating Conditions.....	4	11.2 Layout Examples.....	14
6.4 Thermal Information.....	4	12 Device and Documentation Support	15
6.5 Electrical Characteristics.....	5	12.1 Support Resources.....	15
6.6 Switching Characteristics.....	5	12.2 Trademarks.....	15
6.7 Typical Performance Curves.....	6	12.3 Electrostatic Discharge Caution.....	15
7 Parameter Measurement Information	9	12.4 Glossary.....	15
8 Detailed Description	10	13 Mechanical, Packaging, and Orderable Information	16
8.1 Overview.....	10		
8.2 Functional Block Diagram.....	10		

4 Revision History

NOTE: Page numbers for previous revisions may differ from page numbers in the current version.

DATE	REVISION	NOTES
August 2020	*	Initial Release

5 Pin Configuration and Functions

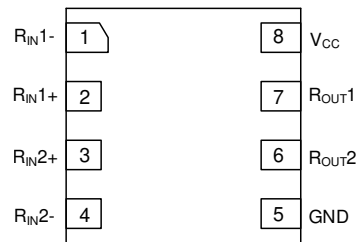

Figure 5-1. DQF Package WSON 8 Pin Top View

Pin Functions

Pin Number	Name	Description
1	R _{IN1} -	Inverting receiver input pin
4	R _{IN2} -	
2	R _{IN1} +	Non-inverting receiver input pin
3	R _{IN2} +	
6	R _{OUT2}	Receiver output pin
7	R _{OUT1}	
8	V _{CC}	Power supply pin, +3.3V +/- 0.3V
5	GND	Ground pin

6 Specifications

6.1 Absolute Maximum Ratings

		MIN	MAX	UNIT
Supply Voltage (V_{CC})		-0.3	4	V
Input Voltage (R_{IN+} , R_{IN-})		-0.3	3.9	V
Output Voltage (R_{OUT})		-0.3	$V_{CC}+0.3$	V
Lead Temperature Range Soldering	(4 sec.)		260	°C
Maximum Junction Temperature			125	°C
Storage temperature, T_{stg}		-65	150	°C

6.2 ESD and Latch-Up Ratings

			VALUE	UNIT
$V_{(ESD)}$	Electrostatic discharge	Human-body model (HBM), per ANSI/ESDA/JEDEC JS-001 ⁽¹⁾	±4000	V
		Charged-device model (CDM), per JEDEC specification JESD22-C101 ⁽²⁾	±1250	
I-Test+	Positive I-Test Latch-Up	Positive I-Test Latchup, per AEC Q100-004 at maximum ambient temperature (all signal pins)	+100	mA
I-Test-	Negative I-Test Latch-Up	Negative I-Test Latchup, per AEC Q100-004 at maximum ambient temperature (all signal pins except pin 3)	-100	mA
		Negative I-Test Latchup, per AEC Q100-004 at maximum ambient temperature (pin 3)	-70	mA

- (1) JEDEC document JEP155 states that 500-V HBM allows safe manufacturing with a standard ESD control process. .
 (2) JEDEC document JEP157 states that 250-V CDM allows safe manufacturing with a standard ESD control process.

6.3 Recommended Operating Conditions

	Min	Typ	Max	Units
Supply Voltage (V_{CC})	+3.0	+3.3	+3.6	V
Receiver Input Voltage	+0.5		+2.1	V
Operating Free Air Temperature (T_A)	-40	25	105	°C

6.4 Thermal Information

THERMAL METRIC ⁽¹⁾		DS90LV028A-Q1	UNIT
		DQF (WSON)	
		8 PINS	
$R_{\theta JA}$	Junction-to-ambient thermal resistance	104.0	°C/W
$R_{\theta JC(bot)}$	Junction-to-case (bottom) thermal resistance	33.3	°C/W
$R_{\theta JB}$	Junction-to-board thermal resistance	27.6	°C/W
ψ_{JT}	Junction-to-top characterization parameter	0.3	°C/W
ψ_{JB}	Junction-to-board characterization parameter	27.4	°C/W

- (1) For more information about traditional and new thermal metrics, see the [Semiconductor and IC Package Thermal Metrics](#) application report.

6.5 Electrical Characteristics

Over Supply Voltage and Operating Temperature ranges, unless otherwise specified. (1) (2)

Symbol	Parameter	Conditions	Pin	Min	Typ	Max	Units
V_{TH}	Differential Input High Threshold	$V_{CM}^{(1)} = +1.2\text{ V}, 0.5 + (V_{ID} /2)\text{ V}, 2.1 - (V_{ID} /2)^{(2)}$	R_{IN+}, R_{IN-}			+100	mV
V_{TL}	Differential Input Low Threshold			-100			mV
I_{IN}	Input Current	$V_{IN} = +2.8\text{ V}$	$V_{CC} = 3.6\text{ V or }0\text{ V}$	-10	± 1	+10	μA
		$V_{IN} = 0\text{ V}$		-10	± 1	+10	μA
		$V_{IN} = +3.6\text{ V}$		-20		+20	μA
V_{OH}	Output High Voltage	$I_{OH} = -0.4\text{ mA}, V_{ID}^{(2)} = +200\text{ mV}$	R_{OUT}	2.7	3.1		V
V_{OL}	Output Low Voltage	$I_{OL} = 2\text{ mA}, V_{ID}^{(2)} = -200\text{ mV}$			0.3	0.5	V
I_{OS}	Output Short Circuit Current	$V_{OUT} = 0\text{ V}^{(3)}$		-100	-50	-15	mA
V_{CL}	Input Clamp Voltage	$I_{CL} = -18\text{ mA}$		-1.5	-0.8		V
I_{CC}	No Load Supply Current	$V_{ID}^{(2)} = +200\text{ mV or }-200\text{ mV}$	V_{CC}		5.4	9	mA

(1) V_{CM} is input common mode voltage $|(V_{RIN+} + V_{RIN-})/2|$

(2) V_{ID} is input differential voltage $(V_{RIN+} - V_{RIN-})$

6.6 Switching Characteristics

Over Supply Voltage and Operating Temperature ranges, unless otherwise specified. (2) (4) (5)

Symbol	Parameter	Conditions	Min	Typ	Max	Units
t_{PHLD}	Differential Propagation Delay High to Low	$C_L = 15\text{ pF}$	1.0	1.6	2.5	ns
t_{PLHD}	Differential Propagation Delay Low to High	$V_{ID} = 200\text{ mV}$	1.0	1.7	2.5	ns
t_{SKD1}	Differential Pulse Skew $ t_{PHLD} - t_{PLHD} ^{(6)}$	(Figure 7-1 and Figure 7-2)	0	50	650	ps
t_{SKD2}	Differential Channel-to-Channel Skew-same device (7)		0	0.1	0.5	ns
t_{SKD3}	Differential Part to Part Skew (8)		0		1.0	ns
t_{SKD4}	Differential Part to Part Skew (9)		0		1.5	ns
t_{TLH}	Rise Time			325	800	ps
t_{THL}	Fall Time			225	800	ps
f_{MAX}	Maximum Operating Frequency (10)			250		MHz

- Current into device pins is defined as positive. Current out of device pins is defined as negative. All voltages are referenced to ground unless otherwise specified (such as V_{ID}).
- All typicals are given for: $V_{CC} = +3.3\text{ V}$ and $T_A = +25^\circ\text{C}$.
- Output short circuit current (I_{OS}) is specified as magnitude only, minus sign indicates direction only. Only one output should be shorted at a time, do not exceed maximum junction temperature specification.
- C_L includes probe and jig capacitance.
- Generator waveform for all tests unless otherwise specified: $f = 1\text{ MHz}$, $Z_O = 50\Omega$, t_r and t_f (0% to 100%) $\leq 3\text{ ns}$ for R_{IN} .
- t_{SKD1} is the magnitude difference in differential propagation delay time between the positive-going-edge and the negative-going-edge of the same channel.
- t_{SKD2} is the differential channel-to-channel skew of any event on the same device. This specification applies to devices having multiple receivers within the integrated circuit.
- t_{SKD3} , part to part skew, is the differential channel-to-channel skew of any event between devices. This specification applies to devices at the same V_{CC} and within 5°C of each other within the operating temperature range.
- t_{SKD4} , part to part skew, is the differential channel-to-channel skew of any event between devices. This specification applies to devices over the recommended operating temperature and voltage ranges, and across process distribution. t_{SKD4} is defined as $|\text{Max} - \text{Min}|$ differential propagation delay.
- f_{MAX} generator input conditions: $t_r = t_f < 1\text{ ns}$ (0% to 100%), 50% duty cycle, differential (1.05V to 1.35 peak to peak). Output criteria: 60%/40% duty cycle, V_{OL} (max 0.4V), V_{OH} (min 2.7V), load = 15 pF (stray plus probes).

6.7 Typical Performance Curves

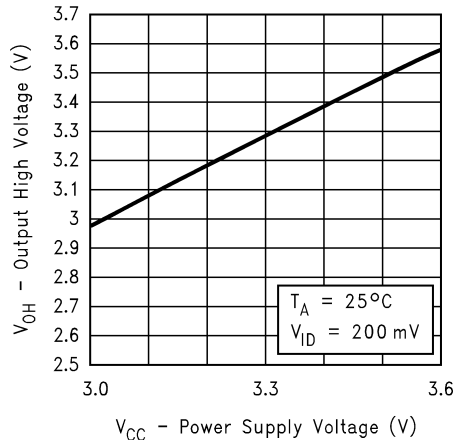

Figure 6-1. Output High Voltage vs Power Supply Voltage

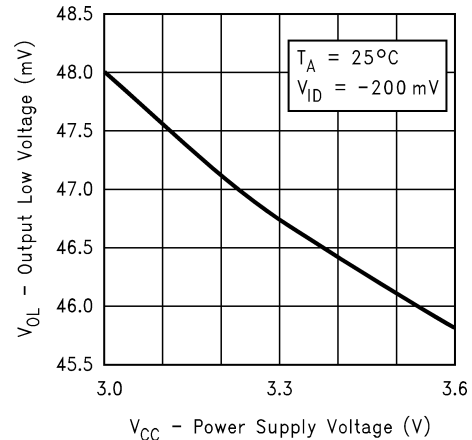

Figure 6-2. Output Low Voltage vs Power Supply Voltage

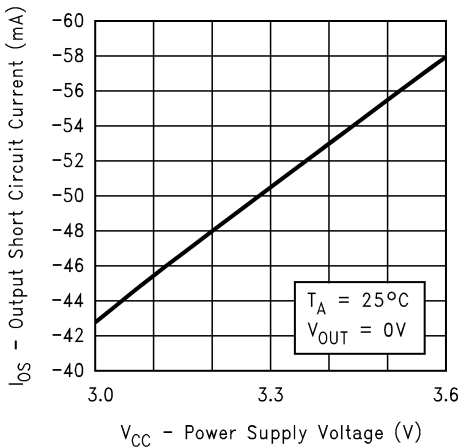

Figure 6-3. Output Short Circuit Current vs Power Supply Voltage

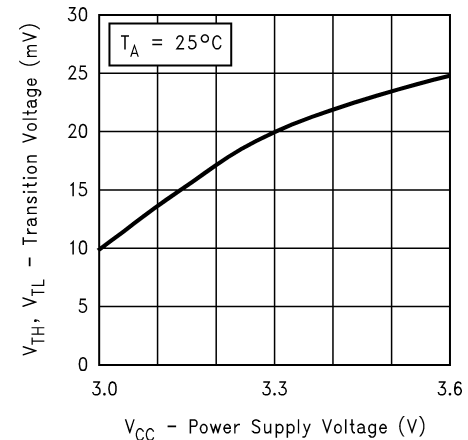

Figure 6-4. Differential Transition Voltage vs Power Supply Voltage

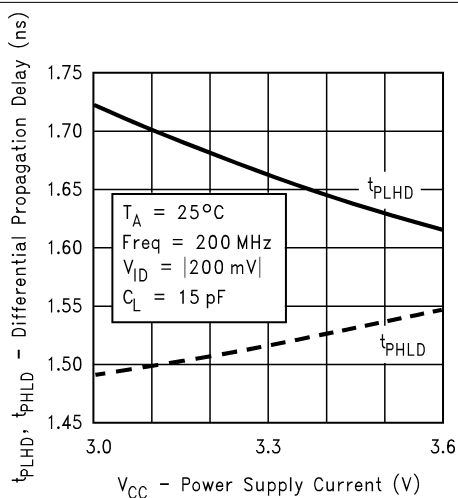

Figure 6-5. Differential Propagation Delay vs Power Supply Voltage

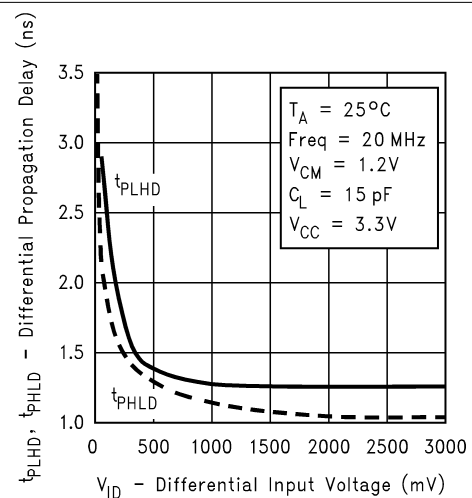

Figure 6-6. Differential Propagation Delay vs Differential Input Voltage

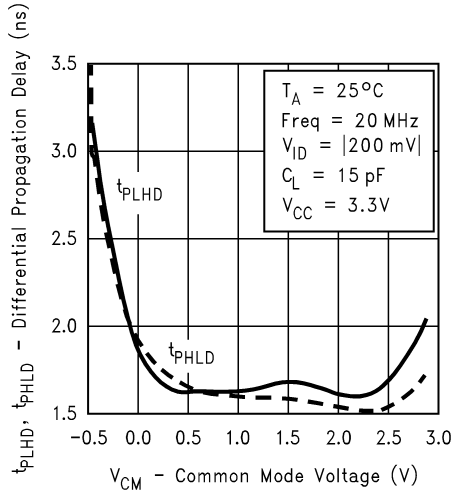

Figure 6-7. Differential Propagation Delay vs Common-Mode Voltage

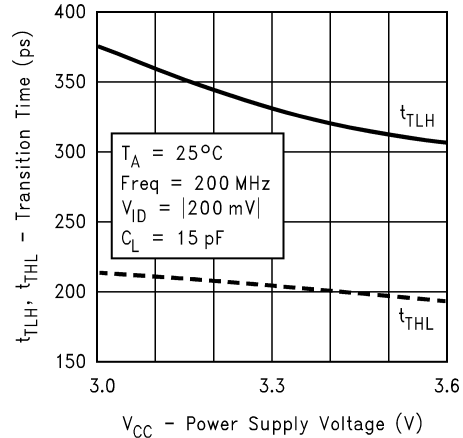

Figure 6-8. Transition Time vs Power Supply Voltage

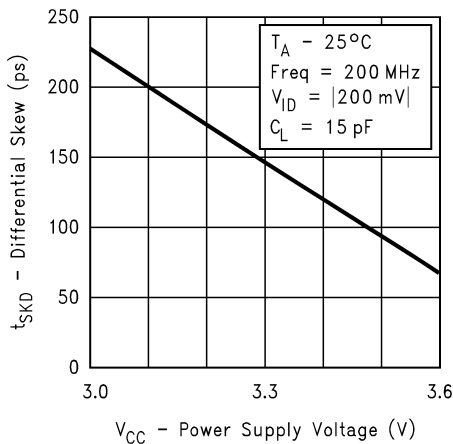

Figure 6-9. Differential Skew vs Power Supply Voltage

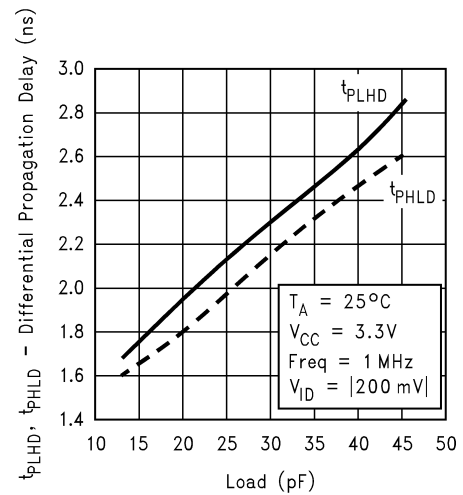

Figure 6-10. Differential Propagation Delay vs Load

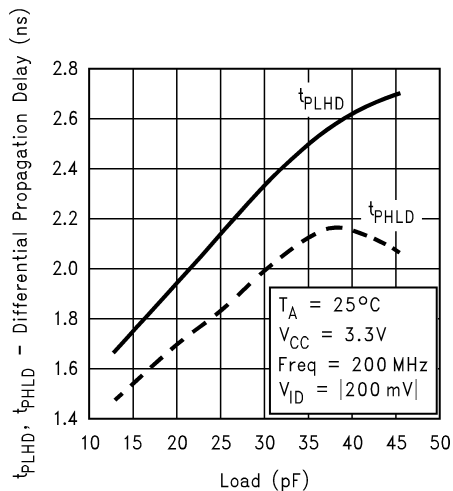

Figure 6-11. Differential Propagation Delay vs Load

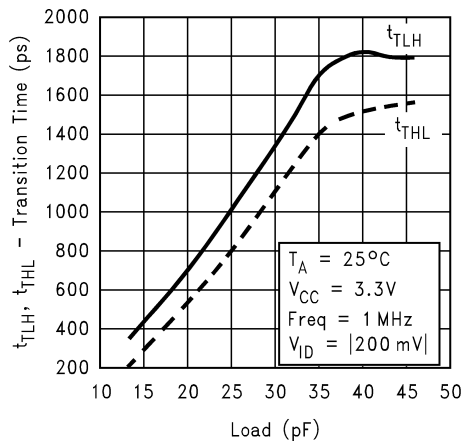

Figure 6-12. Transition Time vs Load

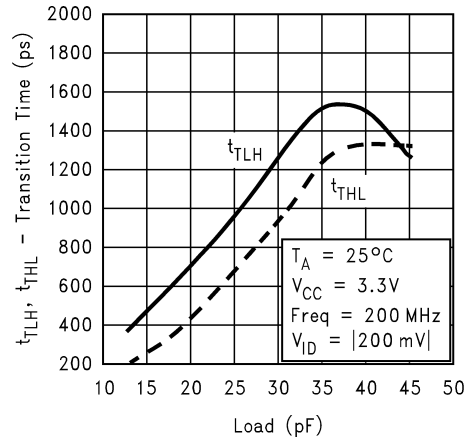

Figure 6-13. Transition Time vs Load

7 Parameter Measurement Information

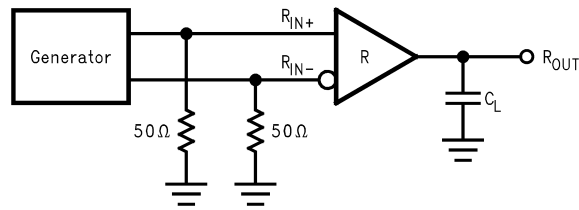

Figure 7-1. Receiver Propagation Delay and Transition Time Test Circuit

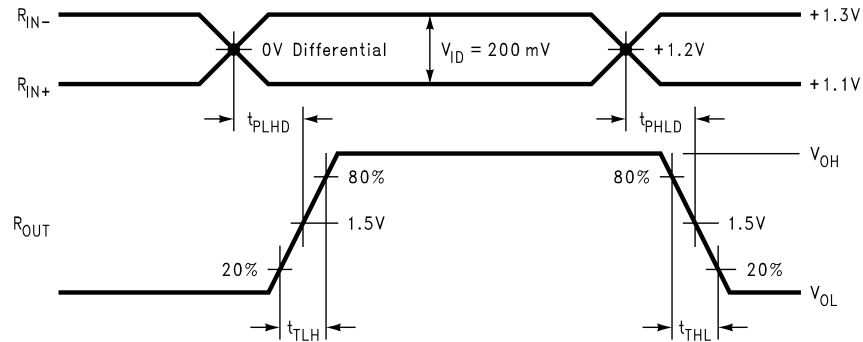

Figure 7-2. Receiver Propagation Delay and Transition Time Waveforms

8 Detailed Description

8.1 Overview

LVDS drivers and receivers are intended to be primarily used in a simple point-to-point configuration as is shown in [Figure 9-1](#). This configuration provides a clean signaling environment for the fast edge rates of the drivers. The receiver is connected to the source through a impedance controlled 100 Ω differential PCB traces. A termination resistor of 100 Ω should be used, and is located as close to the receiver input pins as possible. The termination resistor converts the driver output (current mode) into a voltage that is detected by the receiver.

8.2 Functional Block Diagram

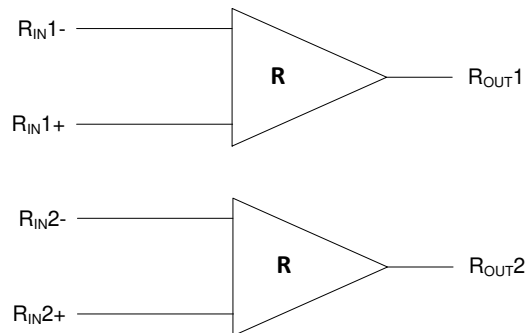

8.3 Feature Description

The DS90LV028A-Q1 differential line receiver is capable of detecting signals as low as 100 mV, over a common-mode range of $0.5 + (V_{ID}/2)$ V to $2.1 - (V_{ID}/2)$ V. This is related to the driver offset voltage which is typically +1.2V. The driven signal is centered around this voltage and may shift ± 0.5 V around this center point. The ± 0.5 V shifting may be the result of a ground potential difference between the driver's ground reference and the receiver's ground reference, the common-mode effects of coupled noise, or a combination of the two. The AC parameters of both receiver input pins are optimized for a recommended operating input voltage range of +0.5V to +2.1V (measured from each pin to ground). The device will operate for receiver input voltages up to V_{CC} , but exceeding V_{CC} will turn on the ESD protection circuitry which will clamp the bus voltages.

8.4 Device Functional Modes

Table 8-1. Truth Table

INPUTS	OUTPUT
$[R_{IN+}] - [R_{IN-}]$	R_{OUT}
$V_{ID} \geq 0.1V$	H
$V_{ID} \leq -0.1V$	L
$-0.1V \leq V_{ID} \leq 0.1V$? ⁽¹⁾

(1) ? indicates state is indeterminate

9 Application and Implementation

Note

Information in the following applications sections is not part of the TI component specification, and TI does not warrant its accuracy or completeness. TI's customers are responsible for determining suitability of components for their purposes. Customers should validate and test their design implementation to confirm system functionality.

9.1 Application Information

General application guidelines and hints for LVDS drivers and receivers may be found in the [LVDS application notes and design guides](#).

9.2 Typical Application

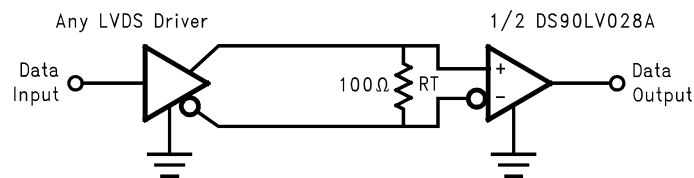

Figure 9-1. Balanced System Point-to-Point Application

9.2.1 Design Requirements

When using LVDS devices, it is important to remember to specify controlled impedance PCB traces. All components of the transmission media must have a matched differential impedance of 100 Ω. They must not introduce major impedance discontinuities.

9.2.2 Detailed Design Procedure

9.2.2.1 Power Decoupling Recommendations

Bypass capacitors must be used on power pins. Use high frequency ceramic (surface mount is recommended) 0.1 μF and 0.01 μF capacitors in parallel at the power supply pin with the smallest value capacitor closest to the device supply pin. Additional scattered capacitors over the printed circuit board will improve decoupling. Multiple vias should be used to connect the decoupling capacitors to the power planes. A 10 μF (35 V) or greater solid tantalum capacitor should be connected at the power entry point on the printed circuit board between the supply and ground.

9.2.2.2 Termination

Use a termination resistor which best matches the differential impedance of your transmission line. The resistor should be between 90 Ω and 110 Ω. Remember that the current mode outputs need the termination resistor to generate the differential voltage. LVDS will not work correctly without resistor termination. Typically, connecting a single resistor across the pair at the receiver end will suffice.

Surface mount 1% resistors are the best. PCB stubs, component lead, and the distance from the termination to the receiver inputs should be minimized. The distance between the termination resistor and the receiver should be < 10 mm (12 mm MAX).

9.2.2.3 Input Failsafe Biasing

External pull up and pull down resistors may be used to provide enough of an offset to enable an input failsafe under open-circuit conditions. This configuration ties the positive LVDS input pin to VDD thru a pull up resistor and the negative LVDS input pin is tied to GND by a pull down resistor. The pull up and pull down resistors should be in the 5 kΩ to 15 kΩ range to minimize loading and waveform distortion to the driver. The common-mode bias point ideally should be set to approximately 1.2 V to be compatible with the internal circuitry. Please refer to application note AN-1194, "Failsafe Biasing of LVDS Interfaces" (SNLA051) for more information.

9.2.2.4 Probing LVDS Transmission Lines

Always use high impedance (> 100 kΩ), low capacitance (< 2 pF) scope probes with a wide bandwidth (1 GHz) scope. Improper probing will give deceiving results.

9.2.3 Application Curves

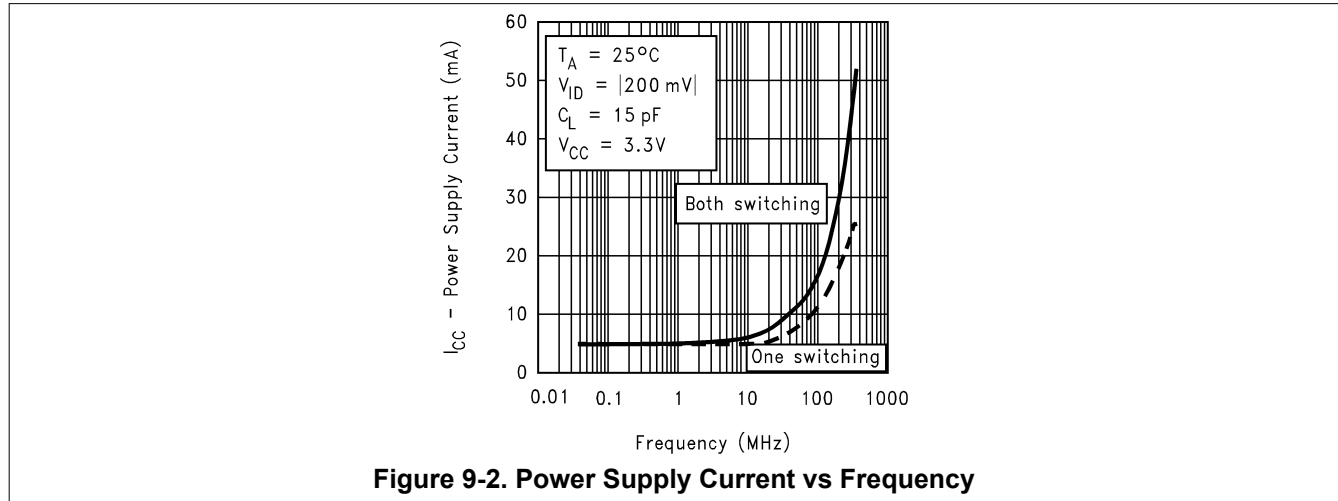

Figure 9-2. Power Supply Current vs Frequency

10 Power Supply Recommendations

Bypass capacitors must be used on power pins. TI recommends using high-frequency, ceramic, 0.1- μ F and 0.01- μ F capacitors in parallel at the power supply pin with the smallest value capacitor closest to the device supply pin. Additional scattered capacitors over the printed-circuit board improves decoupling. Multiple vias must be used to connect the decoupling capacitors to the power planes. A 10- μ F bulk capacitor, 35-V (or greater) solid tantalum capacitor must be connected at the power entry point on the printed-circuit board between the supply and ground.

11 Layout

11.1 Layout Guidelines

11.1.1 Differential Traces

Use controlled impedance traces which match the differential impedance of your transmission trace and termination resistor. Run the differential pair trace lines as close together as possible as soon as they leave the IC (stubs should be < 10mm long). This will help eliminate reflections and ensure noise is coupled as common-mode. In fact, we have seen that differential signals which are 1mm apart radiate far less noise than traces 3mm apart since magnetic field cancellation is much better with the closer traces. In addition, noise induced on the differential lines is much more likely to appear as common-mode which is rejected by the receiver.

Match electrical lengths between traces to reduce skew. Skew between the signals of a pair means a phase difference between signals which destroys the magnetic field cancellation benefits of differential signals and EMI will result! (Note that the velocity of propagation, $v = c/E_r$ where c (the speed of light) = 0.2997 mm/ps or 0.0118 in/ps). Do not rely solely on the autoroute function for differential traces. Carefully review dimensions to match differential impedance and provide isolation for the differential lines. Minimize the number of vias and other discontinuities on the line.

Avoid 90° turns (these cause impedance discontinuities). Use arcs or 45° bevels.

Within a pair of traces, the distance between the two traces should be minimized to maintain common-mode rejection of the receivers. On the printed circuit board, this distance should remain constant to avoid discontinuities in differential impedance. Minor violations at connection points are allowable.

11.1.2 PC Board Considerations

Use at least 4 PCB board layers (top to bottom): LVDS signals, ground, power, TTL signals.

Isolate TTL signals from LVDS signals, otherwise the TTL signals may couple onto the LVDS lines. It is best to put TTL and LVDS signals on different layers which are isolated by a power/ground plane(s).

11.2 Layout Examples

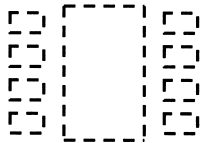

Figure 11-1. WSON Thermal Land Pad and Pin Pads

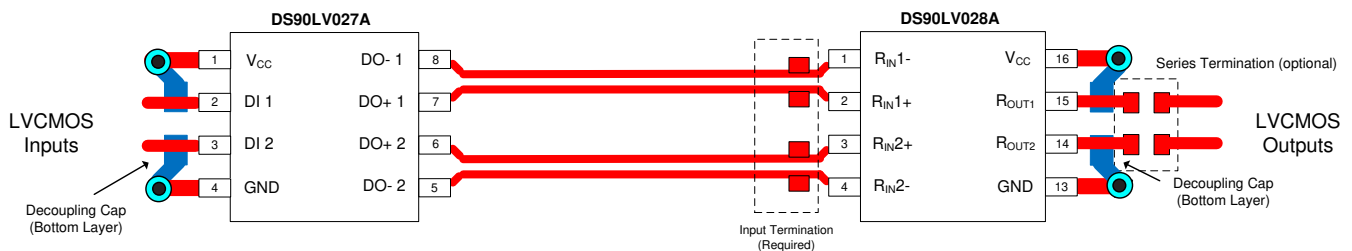

Figure 11-2. Simplified DS90LV027A and DS90LV028A Layout

12 Device and Documentation Support

12.1 Support Resources

[TI E2E™ support forums](#) are an engineer's go-to source for fast, verified answers and design help — straight from the experts. Search existing answers or ask your own question to get the quick design help you need.

Linked content is provided "AS IS" by the respective contributors. They do not constitute TI specifications and do not necessarily reflect TI's views; see TI's [Terms of Use](#).

12.2 Trademarks

TI E2E™ is a trademark of Texas Instruments.

All other trademarks are the property of their respective owners.

12.3 Electrostatic Discharge Caution



This integrated circuit can be damaged by ESD. Texas Instruments recommends that all integrated circuits be handled with appropriate precautions. Failure to observe proper handling and installation procedures can cause damage.

ESD damage can range from subtle performance degradation to complete device failure. Precision integrated circuits may be more susceptible to damage because very small parametric changes could cause the device not to meet its published specifications.

12.4 Glossary

[TI Glossary](#) This glossary lists and explains terms, acronyms, and definitions.

13 Mechanical, Packaging, and Orderable Information

The following pages include mechanical, packaging, and orderable information. This information is the most current data available for the designated devices. This data is subject to change without notice and revision of this document. For browser-based versions of this data sheet, refer to the left-hand navigation.

PACKAGING INFORMATION

Orderable Device	Status (1)	Package Type	Package Drawing	Pins	Package Qty	Eco Plan (2)	Lead finish/ Ball material (6)	MSL Peak Temp (3)	Op Temp (°C)	Device Marking (4/5)	Samples
DS90LV028AQDQFRQ1	ACTIVE	WSON	DQF	8	3000	RoHS & Green	NIPDAUAG	Level-1-260C-UNLIM	-40 to 125	D28Q	Samples
DS90LV028AQDQFTQ1	ACTIVE	WSON	DQF	8	250	RoHS & Green	NIPDAUAG	Level-1-260C-UNLIM	-40 to 125	D28Q	Samples

(1) The marketing status values are defined as follows:

ACTIVE: Product device recommended for new designs.

LIFEBUY: TI has announced that the device will be discontinued, and a lifetime-buy period is in effect.

NRND: Not recommended for new designs. Device is in production to support existing customers, but TI does not recommend using this part in a new design.

PREVIEW: Device has been announced but is not in production. Samples may or may not be available.

OBSELETE: TI has discontinued the production of the device.

(2) **RoHS:** TI defines "RoHS" to mean semiconductor products that are compliant with the current EU RoHS requirements for all 10 RoHS substances, including the requirement that RoHS substance do not exceed 0.1% by weight in homogeneous materials. Where designed to be soldered at high temperatures, "RoHS" products are suitable for use in specified lead-free processes. TI may reference these types of products as "Pb-Free".

RoHS Exempt: TI defines "RoHS Exempt" to mean products that contain lead but are compliant with EU RoHS pursuant to a specific EU RoHS exemption.

Green: TI defines "Green" to mean the content of Chlorine (Cl) and Bromine (Br) based flame retardants meet JS709B low halogen requirements of <=1000ppm threshold. Antimony trioxide based flame retardants must also meet the <=1000ppm threshold requirement.

(3) MSL, Peak Temp. - The Moisture Sensitivity Level rating according to the JEDEC industry standard classifications, and peak solder temperature.

(4) There may be additional marking, which relates to the logo, the lot trace code information, or the environmental category on the device.

(5) Multiple Device Markings will be inside parentheses. Only one Device Marking contained in parentheses and separated by a "~" will appear on a device. If a line is indented then it is a continuation of the previous line and the two combined represent the entire Device Marking for that device.

(6) Lead finish/Ball material - Orderable Devices may have multiple material finish options. Finish options are separated by a vertical ruled line. Lead finish/Ball material values may wrap to two lines if the finish value exceeds the maximum column width.

Important Information and Disclaimer:The information provided on this page represents TI's knowledge and belief as of the date that it is provided. TI bases its knowledge and belief on information provided by third parties, and makes no representation or warranty as to the accuracy of such information. Efforts are underway to better integrate information from third parties. TI has taken and continues to take reasonable steps to provide representative and accurate information but may not have conducted destructive testing or chemical analysis on incoming materials and chemicals. TI and TI suppliers consider certain information to be proprietary, and thus CAS numbers and other limited information may not be available for release.

In no event shall TI's liability arising out of such information exceed the total purchase price of the TI part(s) at issue in this document sold by TI to Customer on an annual basis.

OTHER QUALIFIED VERSIONS OF DS90LV028A-Q1 :

- Catalog: [DS90LV028A](#)

NOTE: Qualified Version Definitions:

- Catalog - TI's standard catalog product

TAPE AND REEL INFORMATION

QUADRANT ASSIGNMENTS FOR PIN 1 ORIENTATION IN TAPE

*All dimensions are nominal

Device	Package Type	Package Drawing	Pins	SPQ	Reel Diameter (mm)	Reel Width W1 (mm)	A0 (mm)	B0 (mm)	K0 (mm)	P1 (mm)	W (mm)	Pin1 Quadrant
DS90LV028AQDQFRQ1	WSON	DQF	8	3000	178.0	8.4	2.25	2.25	1.0	4.0	8.0	Q1
DS90LV028AQDQFTQ1	WSON	DQF	8	250	178.0	8.4	2.25	2.25	1.0	4.0	8.0	Q1

TAPE AND REEL BOX DIMENSIONS



*All dimensions are nominal

Device	Package Type	Package Drawing	Pins	SPQ	Length (mm)	Width (mm)	Height (mm)
DS90LV028AQDQFRQ1	WSON	DQF	8	3000	205.0	200.0	33.0
DS90LV028AQDQFTQ1	WSON	DQF	8	250	205.0	200.0	33.0

DQF0008A



PACKAGE OUTLINE

WSO - 0.8 mm max height

PLASTIC SMALL OUTLINE - NO LEAD

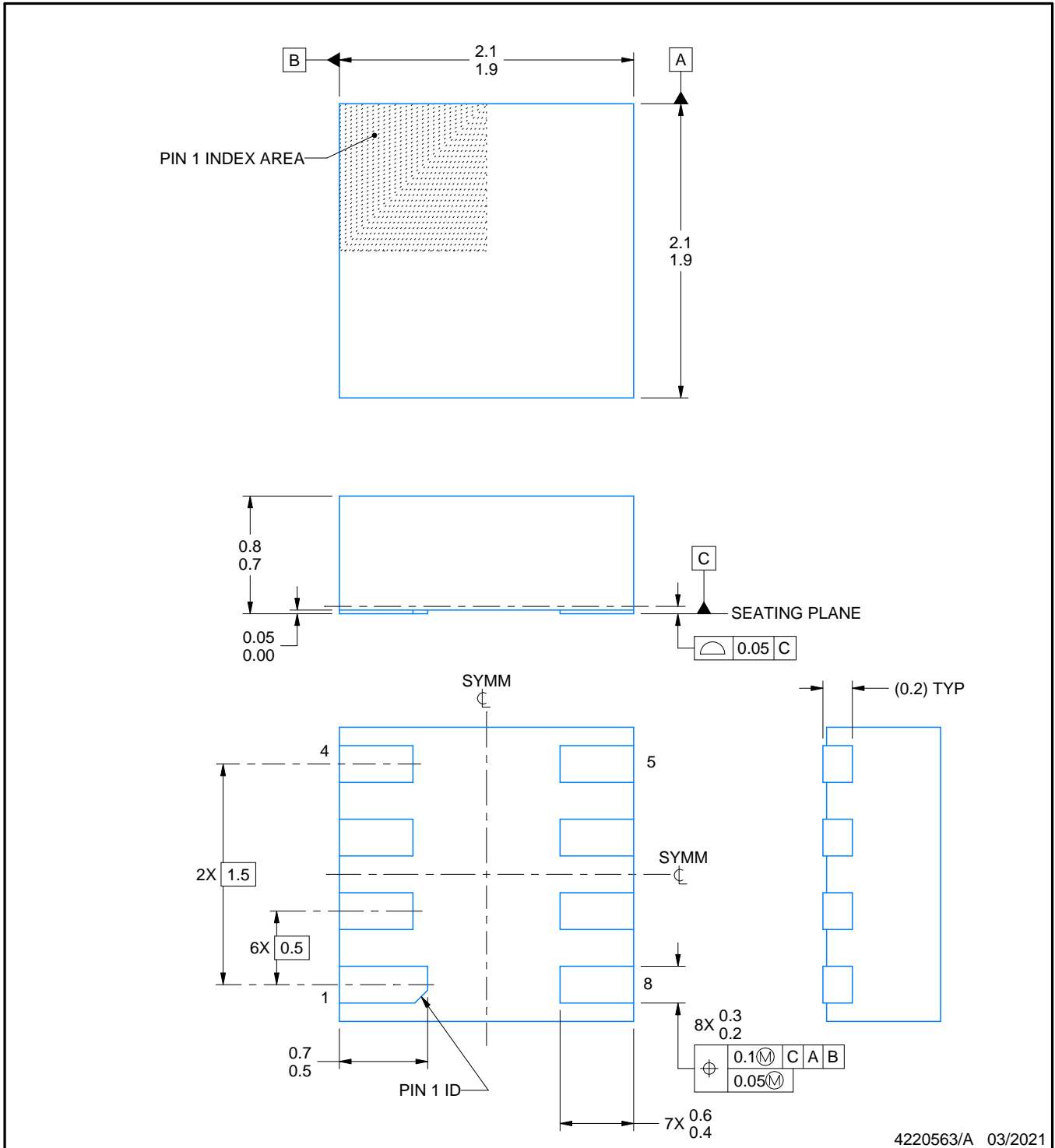

NOTES:

1. All linear dimensions are in millimeters. Any dimensions in parenthesis are for reference only. Dimensioning and tolerancing per ASME Y14.5M.
2. This drawing is subject to change without notice.

EXAMPLE BOARD LAYOUT

DQF0008A

WSON - 0.8 mm max height

PLASTIC SMALL OUTLINE - NO LEAD

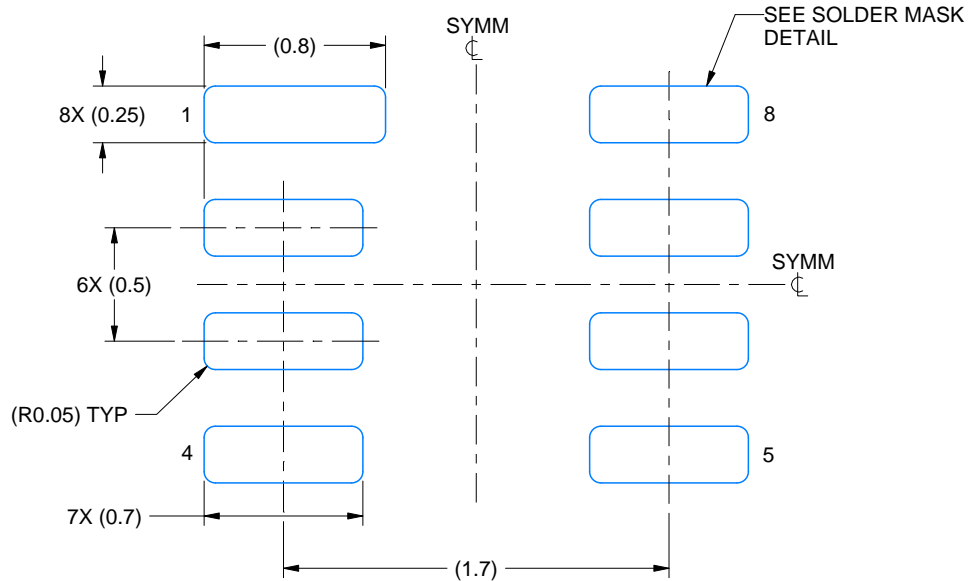

LAND PATTERN EXAMPLE
EXPOSED METAL SHOWN
SCALE: 30X

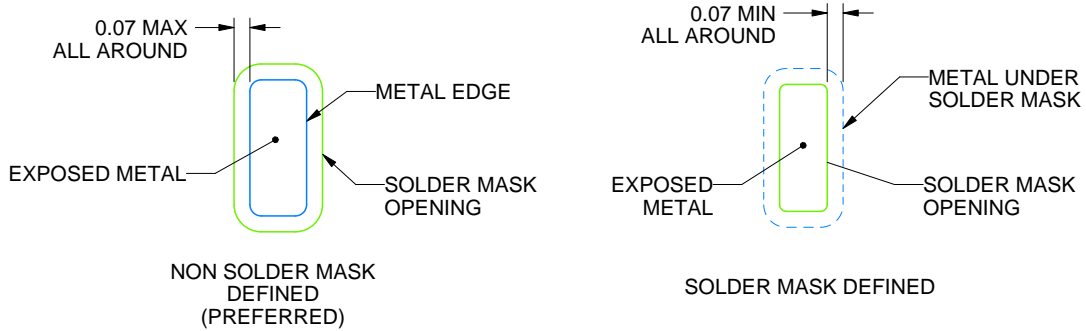

SOLDER MASK DETAILS

4220563/A 03/2021

NOTES: (continued)

- This package is designed to be soldered to a thermal pad on the board. For more information, see Texas Instruments literature number SLUA271 (www.ti.com/lit/slua271).

EXAMPLE STENCIL DESIGN

DQF0008A

WSON - 0.8 mm max height

PLASTIC SMALL OUTLINE - NO LEAD

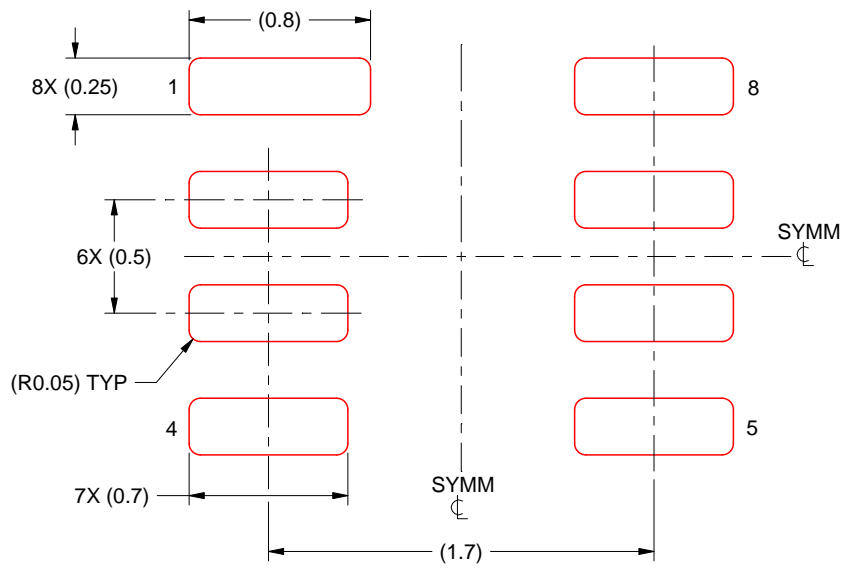

SOLDER PASTE EXAMPLE
BASED ON 0.125 MM THICK STENCIL
SCALE: 30X

4220563/A 03/2021

NOTES: (continued)

4. Laser cutting apertures with trapezoidal walls and rounded corners may offer better paste release. IPC-7525 may have alternate design recommendations.

IMPORTANT NOTICE AND DISCLAIMER

TI PROVIDES TECHNICAL AND RELIABILITY DATA (INCLUDING DATASHEETS), DESIGN RESOURCES (INCLUDING REFERENCE DESIGNS), APPLICATION OR OTHER DESIGN ADVICE, WEB TOOLS, SAFETY INFORMATION, AND OTHER RESOURCES "AS IS" AND WITH ALL FAULTS, AND DISCLAIMS ALL WARRANTIES, EXPRESS AND IMPLIED, INCLUDING WITHOUT LIMITATION ANY IMPLIED WARRANTIES OF MERCHANTABILITY, FITNESS FOR A PARTICULAR PURPOSE OR NON-INFRINGEMENT OF THIRD PARTY INTELLECTUAL PROPERTY RIGHTS.

These resources are intended for skilled developers designing with TI products. You are solely responsible for (1) selecting the appropriate TI products for your application, (2) designing, validating and testing your application, and (3) ensuring your application meets applicable standards, and any other safety, security, or other requirements. These resources are subject to change without notice. TI grants you permission to use these resources only for development of an application that uses the TI products described in the resource. Other reproduction and display of these resources is prohibited. No license is granted to any other TI intellectual property right or to any third party intellectual property right. TI disclaims responsibility for, and you will fully indemnify TI and its representatives against, any claims, damages, costs, losses, and liabilities arising out of your use of these resources.

TI's products are provided subject to TI's Terms of Sale (<https://www.ti.com/legal/termsofsale.html>) or other applicable terms available either on [ti.com](https://www.ti.com) or provided in conjunction with such TI products. TI's provision of these resources does not expand or otherwise alter TI's applicable warranties or warranty disclaimers for TI products.

Mailing Address: Texas Instruments, Post Office Box 655303, Dallas, Texas 75265
Copyright © 2021, Texas Instruments Incorporated