

# LMR36520 SIMPLE SWITCHER<sup>®</sup> 4.2V 至 65V、2A 同步降压转换器

## 1 特性

- 专为可靠耐用的应用设计
  - 高达 70V 的输入瞬态保护
  - 保护功能：热关断、输入欠压锁定、逐周期电流限制和断续短路保护
- 非常适合可扩展的工业电源
  - 与以下器件引脚兼容：
    - LMR36510 (65V、1A)
    - LMR33610/LMR33620/LMR33630/LMR33640 (36V、1A、2A、3A 或 4A)
  - 内部补偿有助于减小解决方案尺寸、降低成本和设计复杂性
  - 频率为 400kHz
- 宽转换范围
  - 输入电压范围：4.2V 至 65V
  - 输出电压范围：1V 至 95% 的  $V_{IN}$
- 在整个负载范围内具有低功率耗散
  - 在 400kHz ( $24V_{IN}$ 、 $5V_{OUT}$ 、1A) 下效率为 90%
  - 在 PFM 模式中提高了轻负载效率
  - 低至 26 $\mu$ A 的工作静态电流
- 具有滤波器和延迟释放功能的电源正常状态输出

## 2 应用

- IP 网络摄像头
- 模拟安防摄像头
- HVAC 阀门和传动器控制
- 交流驱动器和伺服驱动控制模块
- 模拟输入模块和混合 I/O 模块
- 通用宽输入电压电源

## 3 说明

LMR36520 稳压器是一款易于使用的同步降压直流/直流 SIMPLE SWITCHER 转换器。借助集成式高侧和低侧功率 MOSFET，在 4.2V 至 65V 宽输入电压范围内的输出电流可高达 2A。高达 70V 的瞬态电压耐受能力有助于缩小解决方案尺寸和降低成本，以提供过压保护并满足 IEC 61000-4-5 的浪涌抗扰度要求。

LMR36520 采用峰值电流模式控制机制来提供出色的效率和输出电压精度。利用精密使能功能，您可以灵活地直接连接到宽输入电压，或对器件启动和关断进行精确控制。附带内置滤波和延迟功能的电源正常状态标志可提供系统状态的真实指示，免去了使用外部监控器的麻烦。

通过集成和内部补偿，该器件减少了很多外部组件，并提供专为实现简单 PCB 布局而设计的引脚排列方式。该器件的功能集旨在简化各种终端设备的实施。

LMR36520 与 LMR36510 (65V、1A)、LMR33610、LMR33620、LMR33630 和 LMR33640 (36V、1A/2A/3A/4A) 引脚对引脚兼容，完善了 SIMPLE SWITCHER 转换器的最新系列。这提高了宽输入电压转换器在各种常用电压和电流额定值范围内的易用性和可扩展性，无需重新设计电路板布局。因此，不仅降低了总体成本和设计工作量，而且缩短了上市时间。LMR36510 与 LMR36520 (65V、2A)、LMR33610、LMR33620、LMR33630 和 LMR33640 (36V、1A/2A/3A/4A) 引脚对引脚兼容，完善了 SIMPLE SWITCHER 转换器的最新系列。

LMR36520 采用 8 引脚 HSOIC 封装。

### 器件信息(1)

器件型号	封装	封装尺寸 (标称值)
LMR36520	HSOIC (8)	5.00mm x 4.00mm

(1) 如需了解所有可用封装，请参阅数据表末尾的可订购产品附录。

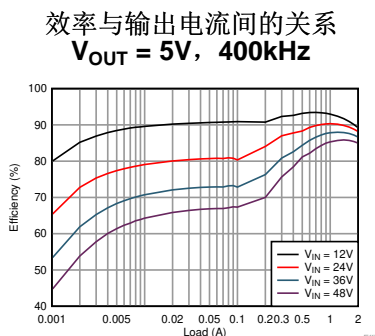

### 简化原理图

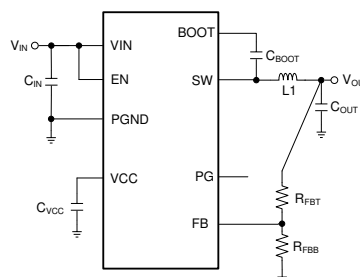

## 目录

<p><b>1 特性</b> ..... 1</p> <p><b>2 应用</b> ..... 1</p> <p><b>3 说明</b> ..... 1</p> <p><b>4 修订历史记录</b> ..... 2</p> <p><b>5 Device Comparison Table</b> ..... 3</p> <p><b>6 Pin Configuration and Functions</b> ..... 4</p> <p><b>7 Specifications</b> ..... 5</p> <p style="padding-left: 20px;">7.1 Absolute Maximum Ratings ..... 5</p> <p style="padding-left: 20px;">7.2 ESD Ratings ..... 5</p> <p style="padding-left: 20px;">7.3 Recommended Operating Conditions ..... 5</p> <p style="padding-left: 20px;">7.4 Thermal Information ..... 6</p> <p style="padding-left: 20px;">7.5 Electrical Characteristics ..... 6</p> <p style="padding-left: 20px;">7.6 Timing Requirements ..... 7</p> <p style="padding-left: 20px;">7.7 Switching Characteristics ..... 7</p> <p style="padding-left: 20px;">7.8 System Characteristics ..... 8</p> <p style="padding-left: 20px;">7.9 Typical Characteristics ..... 9</p> <p><b>8 Detailed Description</b> ..... 10</p> <p style="padding-left: 20px;">8.1 Overview ..... 10</p> <p style="padding-left: 20px;">8.2 Functional Block Diagram ..... 10</p>	<p style="padding-left: 20px;">8.3 Feature Description ..... 10</p> <p style="padding-left: 20px;">8.4 Device Functional Modes ..... 14</p> <p><b>9 Application and Implementation</b> ..... 17</p> <p style="padding-left: 20px;">9.1 Application Information ..... 17</p> <p style="padding-left: 20px;">9.2 Typical Application ..... 17</p> <p style="padding-left: 20px;">9.3 What to Do and What Not to Do ..... 26</p> <p><b>10 Power Supply Recommendations</b> ..... 27</p> <p><b>11 Layout</b> ..... 28</p> <p style="padding-left: 20px;">11.1 Layout Guidelines ..... 28</p> <p style="padding-left: 20px;">11.2 Layout Example ..... 30</p> <p><b>12 器件和文档支持</b> ..... 31</p> <p style="padding-left: 20px;">12.1 器件支持 ..... 31</p> <p style="padding-left: 20px;">12.2 文档支持 ..... 31</p> <p style="padding-left: 20px;">12.3 接收文档更新通知 ..... 31</p> <p style="padding-left: 20px;">12.4 支持资源 ..... 31</p> <p style="padding-left: 20px;">12.5 商标 ..... 31</p> <p style="padding-left: 20px;">12.6 静电放电警告 ..... 31</p> <p style="padding-left: 20px;">12.7 Glossary ..... 31</p> <p><b>13 机械、封装和可订购信息</b> ..... 31</p>
---------------------------------------------------------------------------------------------------------------------------------------------------------------------------------------------------------------------------------------------------------------------------------------------------------------------------------------------------------------------------------------------------------------------------------------------------------------------------------------------------------------------------------------------------------------------------------------------------------------------------------------------------------------------------------------------------------------------------------------------------------------------------------------------------------------------------------------------------------------------------------------------------------------------------------------------------------------------------------------------------------------------------------------------------------------------------------------------------------	------------------------------------------------------------------------------------------------------------------------------------------------------------------------------------------------------------------------------------------------------------------------------------------------------------------------------------------------------------------------------------------------------------------------------------------------------------------------------------------------------------------------------------------------------------------------------------------------------------------------------------------------------------------------------------------------------------------------------------------------------------------------------------------------------------------------------------------------------------------------------------------------------------------------------------------------------------------------------------------------------------------------------------------------------------------------------------------------------------------------------------

## 4 修订历史记录

注：之前版本的页码可能与当前版本有所不同。

Changes from Original (September 2019) to Revision A	Page
<ul style="list-style-type: none"> <li>• 将器件状态从“预告信息”更改为“生产数据” ..... 1</li> </ul>	1

## 5 Device Comparison Table

ORDERABLE PART NUMBER	CURRENT	FPWM	f <sub>sw</sub>	AVAILABILITY
LMR36520ADDAR	2 A	No	400 kHz	Now
LMR36520FADDAR	2 A	Yes	400 kHz	No

## 6 Pin Configuration and Functions

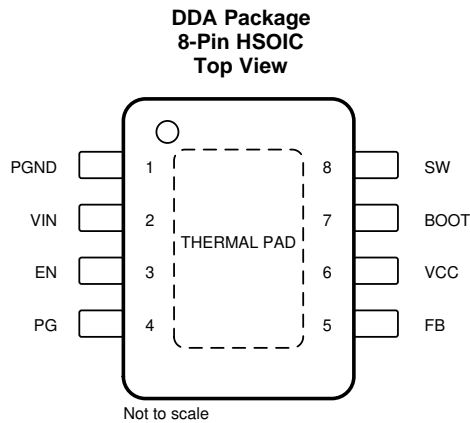

### Pin Functions

PIN		I/O	DESCRIPTION
NAME	NO.		
PGND	1	G	Power and analog ground terminal. Connect to bypass capacitor with short, wide traces. Ground reference for internal references and logic. All electrical parameters are measured with respect to this pin.
VIN	2	P	Input supply to regulator. Connect a high-quality bypass capacitor or capacitors directly to this pin and PGND.
EN	3	A	Enable input to regulator. High = ON, low = OFF. Can be connected directly to VIN; <i>Do not</i> float.
PG	4	A	Open-drain power-good flag output. Connect to suitable voltage supply through a current limiting resistor. High = power OK, low = power bad. Flag pulls low when EN = Low. Can be left open when not used.
FB	5	A	Feedback input to regulator. Connect to tap point of feedback voltage divider. <i>Do not</i> float. <i>Do not</i> ground.
VCC	6	P	Internal 5-V LDO output. Used as supply to internal control circuits. Do not connect to external loads. Can be used as logic supply for power-good flag. Connect a high-quality 1- $\mu$ F capacitor from this pin to PGND.
BOOT	7	P	Bootstrap supply voltage for internal high-side driver. Connect a high-quality 100-nF capacitor from this pin to the SW pin.
SW	8	P	Regulator switch node. Connect to a power inductor.
PAD	THERMAL PAD	Thermal	Major heat dissipation path of the device. A direct thermal connection to a ground plane is required. The PAD is not meant as an electrical interconnect. Electrical characteristics are not ensured.

A = Analog, P = Power, G = Ground

## 7 Specifications

### 7.1 Absolute Maximum Ratings

Over junction temperature range of -40°C to 150°C (unless otherwise noted)<sup>(1)</sup>

		MIN	MAX	UNIT
Input voltage	VIN to PGND	-0.3	70	V
Input voltage	EN to PGND	-0.3	70.3	V
Input voltage	FB to PGND	-0.3	5.5	V
Input voltage	PG to PGND	-0.3	20	V
Output voltage	SW to PGND	-0.3	70.3	V
Output voltage	SW to PGND less than 10-ns transients	-3.5	70	V
Output voltage	CBOOT to SW	-0.3	5.5	V
Output voltage	VCC to PGND	-0.3	5.5	V
Junction Temperature T <sub>J</sub>		-40	150	°C
Storage temperature, T <sub>stg</sub>		-65	150	°C

- (1) Stresses beyond those listed under *Absolute Maximum Ratings* may cause permanent damage to the device. These are stress ratings only, which do not imply functional operation of the device at these or any other conditions beyond those indicated under *Recommended Operating Conditions*. Exposure to absolute-maximum-rated conditions for extended periods may affect device reliability.

### 7.2 ESD Ratings

			VALUE	UNIT
V <sub>(ESD)</sub>	Electrostatic discharge	Human-body model (HBM) <sup>(1)</sup>	±2500	V
		Charged-device model (CDM) <sup>(2)</sup>	±750	

- (1) JEDEC document JEP155 states that 500-V HBM allows safe manufacturing with a standard ESD control process.  
(2) JEDEC document JEP157 states that 250-V CDM allows safe manufacturing with a standard ESD control process.

### 7.3 Recommended Operating Conditions

Over the recommended operating junction temperature range of -40 °C to 125 °C (unless otherwise noted)<sup>(1)</sup>

		MIN	MAX	UNIT
Input voltage	VIN to PGND	4.2	65	V
	EN to PGND <sup>(2)</sup>	0	65	V
	PG to PGND <sup>(2)</sup>	0	18	V
Output voltage	V <sub>OUT</sub>	1	28	V
Output current	I <sub>OUT</sub>	0	2	A

- (1) Recommended operating conditions indicate conditions for which the device is intended to be functional, but do not ensure specific performance limits. For ensured specifications, see Electrical Characteristics.  
(2) The voltage on this pin must not exceed the voltage on the VIN pin by more than 0.3 V.

## 7.4 Thermal Information

THERMAL METRIC <sup>(1)</sup>		LMR36520	
		DDA (HSOIC)	
		8 PINS	
			UNIT
R <sub>θJA</sub>	Junction-to-ambient thermal resistance	42.9	°C/W
R <sub>θJC(top)</sub>	Junction-to-case (top) thermal resistance	54	°C/W
R <sub>θJB</sub>	Junction-to-board thermal resistance	13.6	°C/W
ψ <sub>JT</sub>	Junction-to-top characterization parameter	4.3	°C/W
ψ <sub>JB</sub>	Junction-to-board characterization parameter	13.8	°C/W
R <sub>θJC(bot)</sub>	Junction-to-case (bottom) thermal resistance	4.3	°C/W

- (1) For more information about traditional and new thermal metrics, see the [Semiconductor and IC Package Thermal Metrics](#) application report.

## 7.5 Electrical Characteristics

Limits apply over operating junction temperature (T<sub>J</sub>) range of –40°C to +125°C, unless otherwise stated. Minimum and Maximum limits<sup>(1)</sup> are specified through test, design or statistical correlation. Typical values represent the most likely parametric norm at T<sub>J</sub> = 25°C, and are provided for reference purposes only. Unless otherwise stated, the following conditions apply: V<sub>IN</sub> = 24 V.

PARAMETER		TEST CONDITIONS	MIN	TYP	MAX	UNIT
<b>SUPPLY VOLTAGE (VIN PIN)</b>						
I <sub>Q-nonSW</sub>	Operating quiescent current (non-switching) <sup>(2)</sup>	V <sub>EN</sub> = 3.3 V (PFM variant only)		26	36	μA
I <sub>SD</sub>	Shutdown quiescent current; measured at VIN pin	V <sub>EN</sub> = 0 V		5.3		μA
<b>ENABLE (EN PIN)</b>						
V <sub>EN-VCC-H</sub>	Enable input high level for V <sub>CC</sub> output	V <sub>ENABLE</sub> rising			1.14	V
V <sub>EN-VCC-L</sub>	Enable input low level for V <sub>CC</sub> output	V <sub>ENABLE</sub> falling	0.3			V
V <sub>EN-VOUT-H</sub>	Enable input high level for V <sub>OUT</sub>	V <sub>ENABLE</sub> rising	1.157	1.231	1.3	V
V <sub>EN-VOUT-HYS</sub>	Enable input hysteresis for V <sub>OUT</sub>	Hysteresis below V <sub>ENABLE-H</sub> ; falling		110		mV
I <sub>LKG-EN</sub>	Enable input leakage current	V <sub>EN</sub> = 3.3V		2.7		nA
<b>INTERNAL LDO (VCC PIN)</b>						
V <sub>CC</sub>	Internal V <sub>CC</sub> voltage	6 V ≤ V <sub>IN</sub> ≤ 65 V	4.75	5	5.25	V
V <sub>CC-UVLO-Rising</sub>	Internal V <sub>CC</sub> undervoltage lockout	V <sub>CC</sub> rising	3.6	3.8	4.0	V
V <sub>CC-UVLO-Falling</sub>	Internal V <sub>CC</sub> undervoltage lockout	V <sub>CC</sub> falling	3.1	3.3	3.5	V
<b>VOLTAGE REFERENCE (FB PIN)</b>						
V <sub>FB</sub>	Feedback voltage		0.985	1	1.015	V
I <sub>LKG-FB</sub>	Feedback leakage current	FB = 1 V		2.1		nA
<b>CURRENT LIMITS AND HICCUP</b>						
I <sub>SC</sub>	High-side current limit <sup>(3)</sup>		2.4	3	3.6	A
I <sub>LS-LIMIT</sub>	Low-side current limit <sup>(3)</sup>		1.8	2.3	2.8	A
I <sub>L-ZC</sub>	Zero cross detector threshold	PFM variants only		0.04		A
I <sub>PEAK-MIN</sub>	Minimum inductor peak current <sup>(3)</sup>			0.59		A
I <sub>L-NEG</sub>	Negative current limit <sup>(3)</sup>	FPWM variant only		–1.7		A

- (1) MIN and MAX limits are 100% production tested at 25°C. Limits over the operating temperature range verified through correlation using Statistical Quality Control (SQC) methods. Limits are used to calculate Average Outgoing Quality Level (AOQL).
- (2) This is the current used by the device open loop. It does not represent the total input current of the system when in regulation.
- (3) The current limit values in this table are tested, open loop, in production. They may differ from those found in a closed loop application.

## Electrical Characteristics (continued)

Limits apply over operating junction temperature ( $T_J$ ) range of  $-40^{\circ}\text{C}$  to  $+125^{\circ}\text{C}$ , unless otherwise stated. Minimum and Maximum limits<sup>(1)</sup> are specified through test, design or statistical correlation. Typical values represent the most likely parametric norm at  $T_J = 25^{\circ}\text{C}$ , and are provided for reference purposes only. Unless otherwise stated, the following conditions apply:  $V_{IN} = 24\text{ V}$ .

PARAMETER		TEST CONDITIONS	MIN	TYP	MAX	UNIT
<b>POWER GOOD (PGOOD PIN)</b>						
$V_{PG-HIGH-UP}$	Power-Good upper threshold - rising	% of FB voltage	105%	107%	110%	
$V_{PG-LOW-DN}$	Power-Good lower threshold - falling	% of FB voltage	90%	93%	95%	
$V_{PG-HYS}$	Power-Good hysteresis (rising & falling)	% of FB voltage		1.5%		
$V_{PG-VALID}$	Minimum input voltage for proper Power-Good function				2	V
$R_{PG}$	Power-Good on-resistance	$V_{EN} = 2.5\text{ V}$		80	165	$\Omega$
$R_{PG}$	Power-Good on-resistance	$V_{EN} = 0\text{ V}$		35	90	$\Omega$
<b>MOSFETS</b>						
$R_{DS-ON-HS}$	High-side MOSFET ON-resistance	$I_{OUT} = 0.5\text{ A}$		245	465	m $\Omega$
$R_{DS-ON-LS}$	Low-side MOSFET ON-resistance	$I_{OUT} = 0.5\text{ A}$		165	310	m $\Omega$

## 7.6 Timing Requirements

Limits apply over operating junction temperature ( $T_J$ ) range of  $-40^{\circ}\text{C}$  to  $+125^{\circ}\text{C}$ , unless otherwise stated. Minimum and Maximum limits<sup>(1)</sup> are specified through test, design or statistical correlation. Typical values represent the most likely parametric norm at  $T_J = 25^{\circ}\text{C}$ , and are provided for reference purposes only. Unless otherwise stated, the following conditions apply:  $V_{IN} = 24\text{ V}$ .

		MIN	NOM	MAX	UNIT
$t_{ON-MIN}$	Minimum switch on-time		92		ns
$t_{OFF-MIN}$	Minimum switch off-time		80	102	ns
$t_{ON-MAX}$	Maximum switch on-time		7	12	$\mu\text{s}$
$t_{SS}$	Internal soft-start time	3	4.5	6	ms

(1) MIN and MAX limits are 100% production tested at  $25^{\circ}\text{C}$ . Limits over the operating temperature range verified through correlation using Statistical Quality Control (SQC) methods. Limits are used to calculate Average Outgoing Quality Level (AOQL).

## 7.7 Switching Characteristics

$T_J = -40^{\circ}\text{C}$  to  $125^{\circ}\text{C}$ ,  $V_{IN} = 24\text{ V}$  (unless otherwise noted)

PARAMETER		TEST CONDITIONS	MIN	TYP	MAX	UNIT
<b>OSCILLATOR</b>						
$F_{OSC}$	Internal oscillator frequency	400-kHz variant	340	400	460	kHz

## 7.8 System Characteristics

The following specifications apply to a typical application circuit with nominal component values. Specifications in the typical (TYP) column apply to  $T_J = 25^\circ\text{C}$  only. Specifications in the minimum (MIN) and maximum (MAX) columns apply to the case of typical components over the temperature range of  $T_J = -40^\circ\text{C}$  to  $125^\circ\text{C}$ . *These specifications are not ensured by production testing.*

PARAMETER		TEST CONDITIONS	MIN	TYP	MAX	UNIT
$V_{IN}$	Operating input voltage range		4.2		65	V
$V_{OUT}$	Adjustable output voltage regulation <sup>(1)</sup>	PFM operation	-1.5%		2.5%	
$V_{OUT}$	Adjustable output voltage regulation <sup>(1)</sup>	FPWM operation	-1.5%		1.5%	
$I_{SUPPLY}$	Input supply current when in regulation	$V_{IN} = 24\text{ V}$ , $V_{OUT} = 3.3\text{ V}$ , $I_{OUT} = 0\text{ A}$ , $R_{FBT} = 1\text{ M}\Omega$ , PFM variant		26		$\mu\text{A}$
$D_{MAX}$	Maximum switch duty cycle <sup>(2)</sup>			98%		
$V_{HC}$	FB pin voltage required to trip short-circuit hiccup mode			0.4		V
$t_D$	Switch voltage dead time			2		ns
$T_{SD}$	Thermal shutdown temperature	Shutdown temperature		170		$^\circ\text{C}$
$T_{SD}$	Thermal shutdown temperature	Recovery temperature		158		$^\circ\text{C}$

(1) Deviation in  $V_{OUT}$  from nominal output voltage value at  $V_{IN} = 24\text{ V}$ ,  $I_{OUT} = 0\text{ A}$  to full load

(2) In dropout the switching frequency drops to increase the effective duty cycle. The lowest frequency is clamped at approximately:  $F_{MIN} = 1 / (t_{ON-MAX} + t_{OFF-MIN})$ .  $D_{MAX} = t_{ON-MAX} / (t_{ON-MAX} + t_{OFF-MIN})$ .



### 7.9 Typical Characteristics

Unless otherwise specified the following conditions apply:  $T_A = 25^\circ\text{C}$  and  $V_{IN} = 24\text{ V}$ .

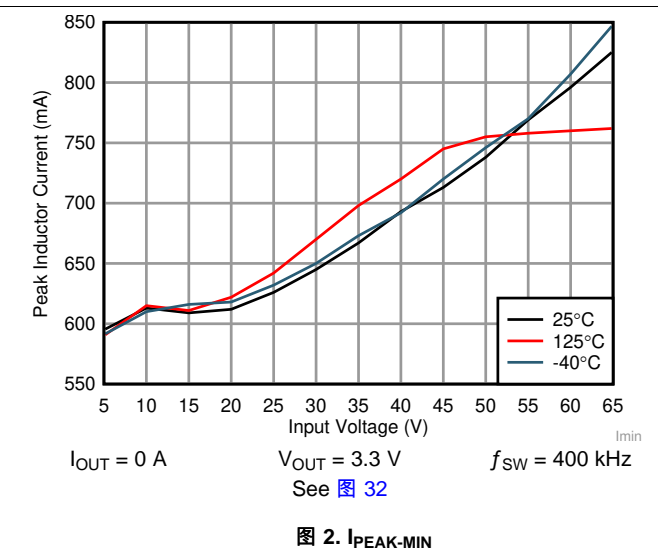
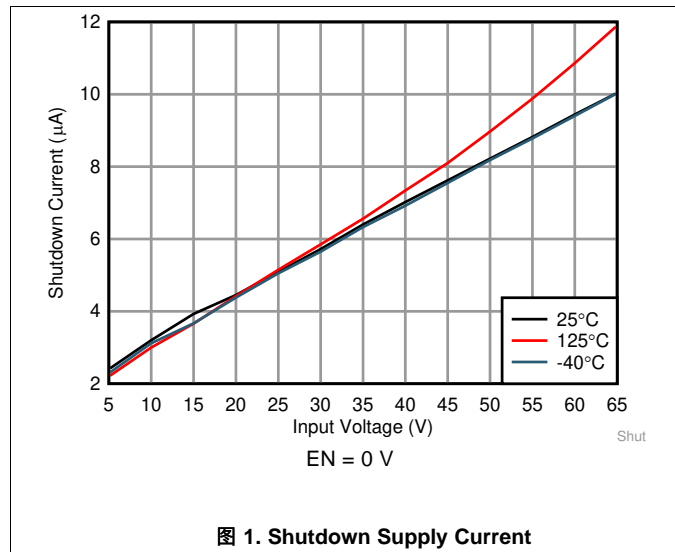

## 8 Detailed Description

### 8.1 Overview

The LMR36520 is a synchronous peak-current mode buck regulator designed for a wide variety of industrial applications. The regulator automatically switches modes between PFM and PWM, depending on load. At heavy loads, the device operates in PWM at a constant switching frequency. At light loads, the mode changes to PFM with diode emulation, allowing DCM. This reduces the input supply current and keeps efficiency high. The device features internal loop compensation, which reduces design time and requires fewer external components than externally compensated regulators.

### 8.2 Functional Block Diagram

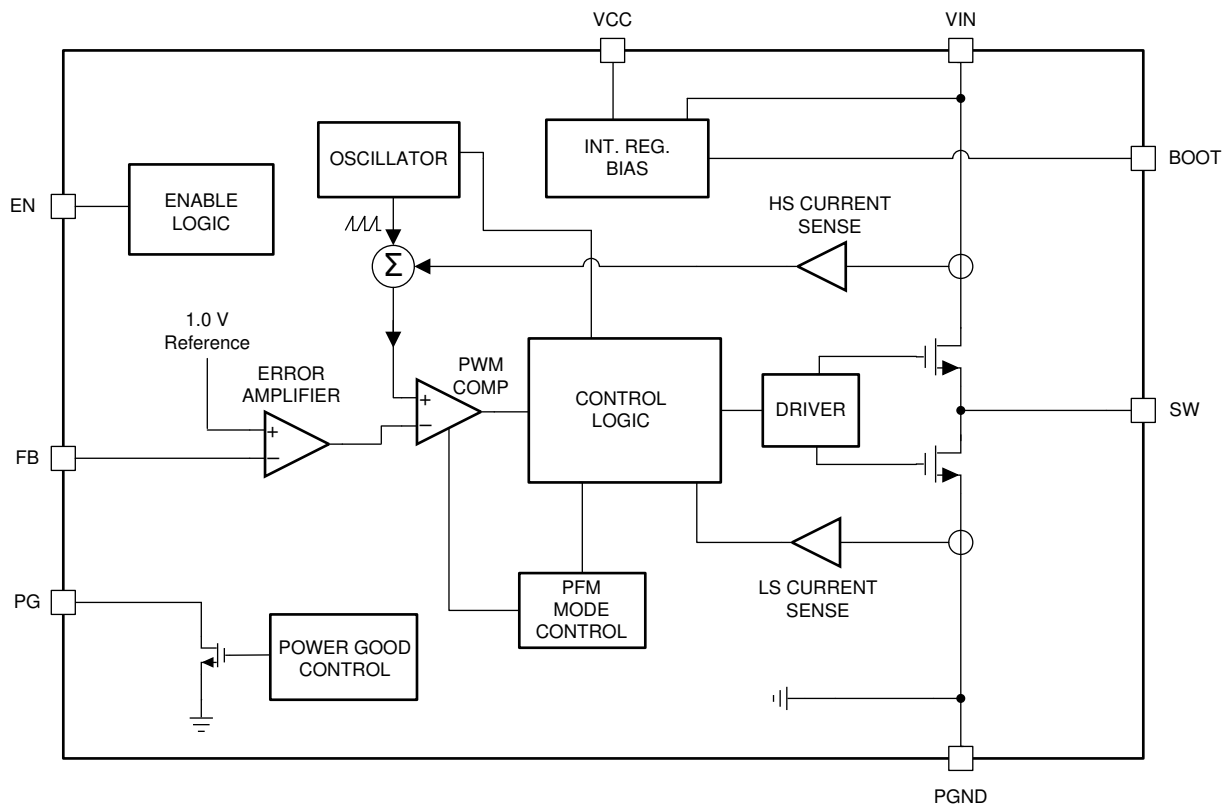

### 8.3 Feature Description

#### 8.3.1 Power-Good Flag Output

The power-good flag function (PG output pin) of the LMR36520 can be used to reset a system microprocessor whenever the output voltage is out of regulation. This open-drain output goes low under fault conditions, such as current limit and thermal shutdown, as well as during normal start-up. A glitch filter prevents false flag operation for short excursions of the output voltage, such as during line and load transients. Output voltage excursions lasting less than  $t_{PG}$  do not trip the power-good flag. Power-good operation can best be understood by referencing [Figure 3](#) and [Figure 4](#). Note that during initial power-up, a delay of about 4 ms (typical) is inserted from the time that EN is asserted to the time that the power-good flag goes high. This delay only occurs during start-up and is not encountered during normal operation of the power-good function.

The power-good output consists of an open-drain NMOS, requiring an external pullup resistor to a suitable logic supply. It can also be pulled up to either VCC or  $V_{OUT}$  through an appropriate resistor, as desired. If this function is not needed, the PG pin must be grounded. When EN is pulled low, the flag output is also forced low. With EN low, power good remains valid as long as the input voltage is  $\geq 2$  V (typical). Limit the current into this pin to  $\leq 4$  mA.

## Feature Description (接下页)



图 3. Static Power-Good Operation



图 4. Power-Good Timing Behavior

### 8.3.2 Enable and Start-up

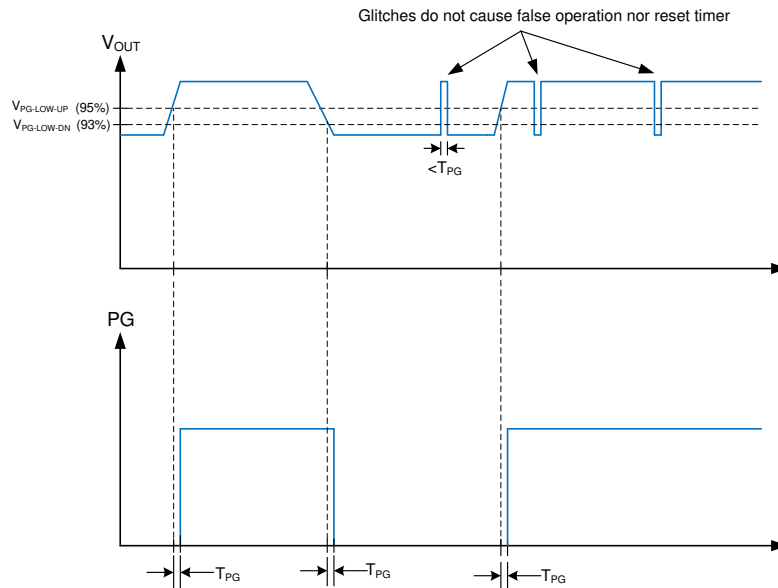
Start-up and shutdown are controlled by the EN input. This input features precision thresholds, allowing the use of an external voltage divider to provide an adjustable input UVLO (see the [External UVLO](#) section). Applying a voltage of  $\geq V_{EN-VCC\_H}$  causes the device to enter standby mode, powering the internal VCC, but not producing an output voltage. Increasing the EN voltage to  $V_{EN-H}$  fully enables the device, allowing it to enter start-up mode and begin the soft-start period. When the EN input is brought below  $V_{EN-H}$  by  $V_{EN-HYS}$ , the regulator stops running and enters standby mode. If the EN voltage decreases below  $V_{EN-VCC-L}$ , the device shuts down. 图 5 shows this behavior. The EN input can be connected directly to VIN if this feature is not needed. This input must not be allowed to float. The values for the various EN thresholds can be found in the [Electrical Characteristics](#) table.

**Feature Description (接下页)**

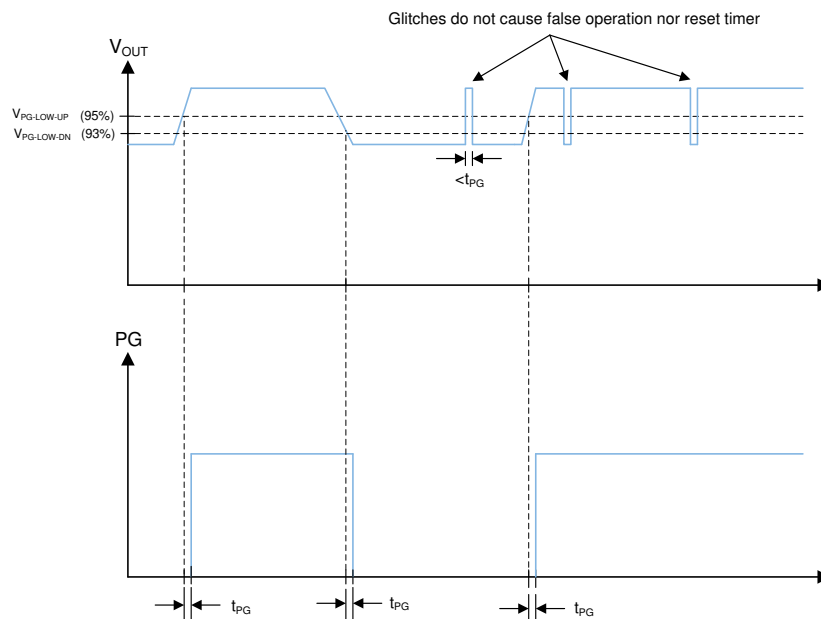
The LMR36520 utilizes a reference-based soft start that prevents output voltage overshoots and large inrush currents as the regulator is starting up.



图 5. Precision Enable Behavior

Feature Description (接下页)

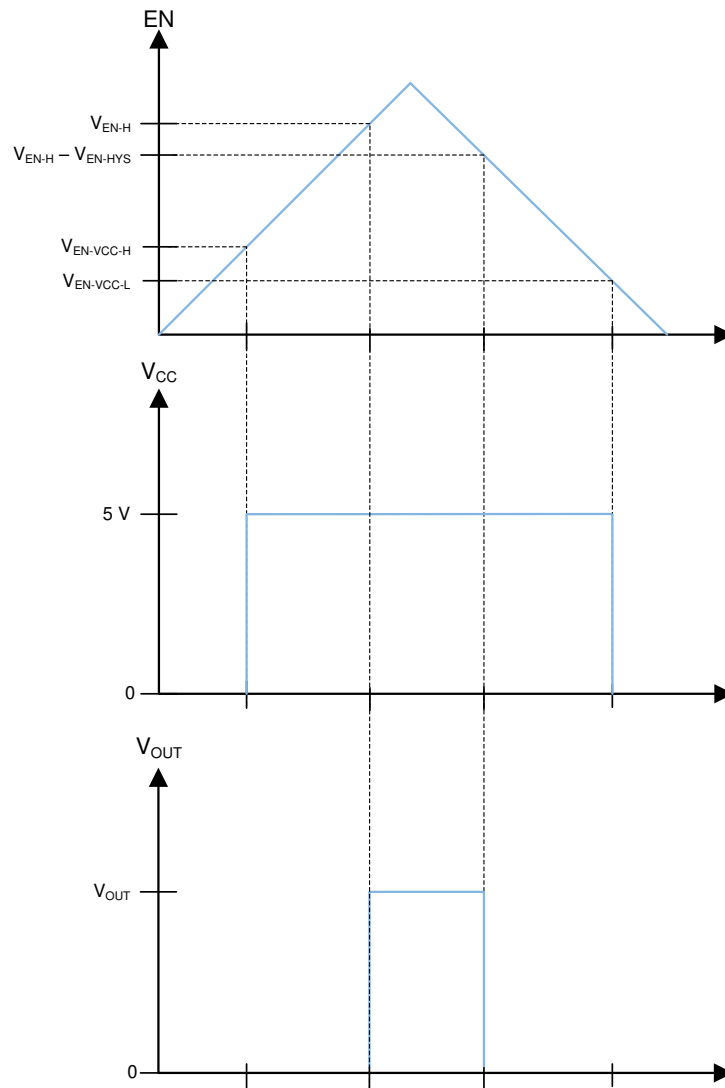

图 6. Typical Start-up Behavior  
 $V_{IN} = 24\text{ V}$ ,  $V_{OUT} = 5\text{ V}$ ,  $I_{OUT} = 2\text{ A}$

8.3.3 Current Limit and Short Circuit

The LMR36520 incorporates valley current limit for normal overloads and for short-circuit protection. In addition, the high-side power MOSFET is protected from excessive current by a peak-current limit circuit. Cycle-by-cycle current limit is used for overloads while hiccup mode is used for short circuits. Finally, a zero current detector is used on the low-side power MOSFET to implement diode emulation at light loads (see the [Glossary](#)).

During overloads, the low-side current limit,  $I_{LIMIT}$ , determines the maximum load current that the LMR36520 can supply. When the low-side switch turns on, the inductor current begins to ramp down. If the current does not fall below  $I_{LIMIT}$  before the next turnon cycle, then that cycle is skipped, and the low-side MOSFET is left on until the current falls below  $I_{LIMIT}$ . This is somewhat different than the more typical peak-current limit and results in [公式 1](#) for the maximum load current.

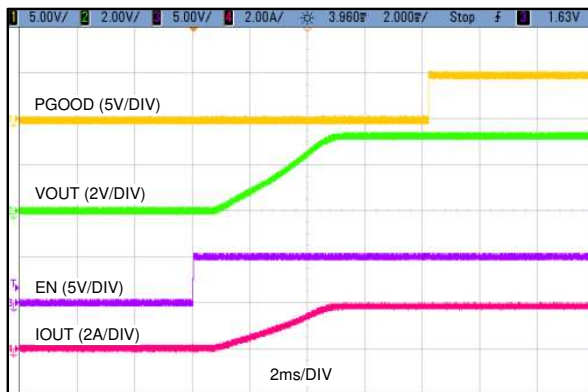
$$I_{OUT}|_{max} = I_{LIMIT} + \frac{(V_{IN} - V_{OUT})}{2 \cdot f_{SW} \cdot L} \cdot \frac{V_{OUT}}{V_{IN}}$$

where

- $f_{SW}$  = switching frequency
- $L$  = inductor value

(1)

If, during current limit, the voltage on the FB input falls below about 0.4 V due to a short circuit, the device enters into hiccup mode. In this mode, the device stops switching for  $t_{HC}$ , or about 94 ms, and then goes through a normal re-start with soft start. If the short-circuit condition remains, the device runs in current limit for about 20 ms (typical) and then shuts down again. This cycle repeats as long as the short-circuit condition persists. This mode of operation reduces the temperature rise of the device during a hard short on the output. Of course, the output current is greatly reduced during hiccup mode. Once the output short is removed and the hiccup delay is passed, the output voltage recovers normally.

The high-side current limit trips when the peak inductor current reaches  $I_{SC}$ . This is a cycle-by-cycle current limit and does not produce any frequency or load current foldback. It is meant to protect the high-side MOSFET from excessive current. Under some conditions, such as high input voltages, this current limit can trip before the low-side protection. Under this condition,  $I_{SC}$  determines the maximum output current. Note that  $I_{SC}$  varies with duty cycle.

## Feature Description (接下页)

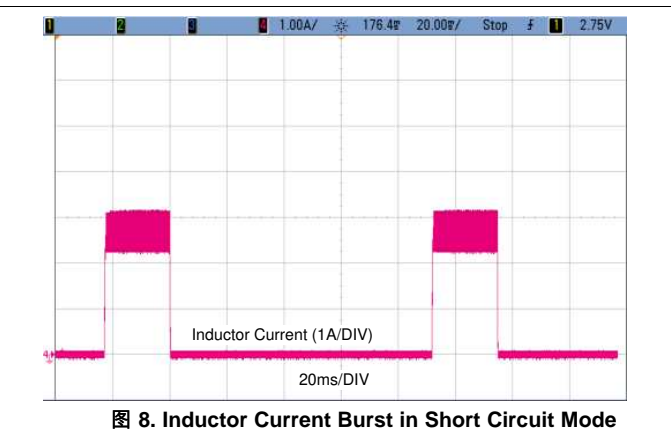
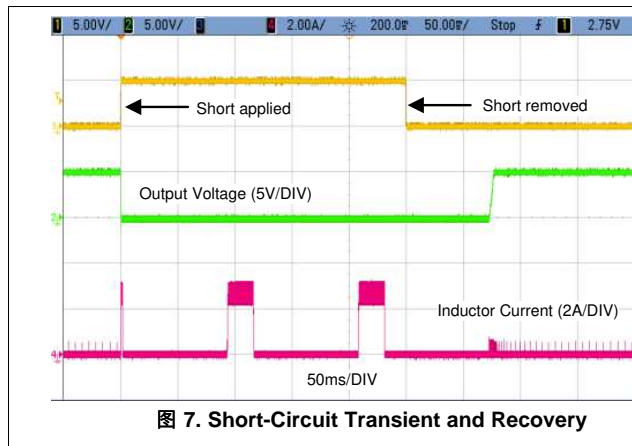

### 8.3.4 Undervoltage Lockout and Thermal Shutdown

The LMR36520 incorporates an undervoltage lockout feature on the output of the internal LDO at the VCC pin. When VCC reaches about 3.7 V, the device is ready to receive an EN signal and start up. When VCC falls below about 3 V, the device shuts down, regardless of EN status. Because the LDO is in dropout during these transitions, the previously mentioned values roughly represent the input voltage levels during the transitions.

Thermal shutdown is provided to protect the regulator from excessive junction temperature. When the junction temperature reaches about 170°C, the device shuts down; re-start occurs when the temperature falls to about 158°C. For safe operation, the device must not be allowed to go into a short circuit condition while in thermal shutdown.

## 8.4 Device Functional Modes

### 8.4.1 Auto Mode

In auto mode, the device moves between PWM and PFM as the load changes. At light loads, the regulator operates in PFM. At higher loads, the mode changes to PWM.

In PWM, the regulator operates as a constant frequency, current mode, full-synchronous converter using PWM to regulate the output voltage. While operating in this mode, the output voltage is regulated by switching at a constant frequency and modulating the duty cycle to control the power to the load. This provides excellent line and load regulation and low output voltage ripple.

In PFM, the high-side MOSFET is turned on in a burst of one or more pulses to provide energy to the load. The duration of the burst depends on how long it takes the inductor current to reach  $I_{PEAK-MIN}$ . The frequency of these bursts is adjusted to regulate the output, while diode emulation is used to maximize efficiency (see the [Glossary](#)). This mode provides high light-load efficiency by reducing the amount of input supply current required to regulate the output voltage at small loads. This trades off very good light-load efficiency for larger output voltage ripple and variable switching frequency. Also, a small increase in output voltage occurs at light loads. The actual switching frequency and output voltage ripple depend on the input voltage, output voltage, and load.

Device Functional Modes (接下页)

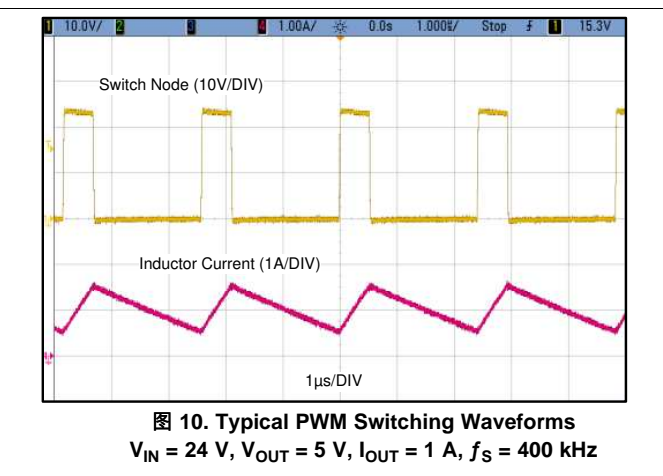
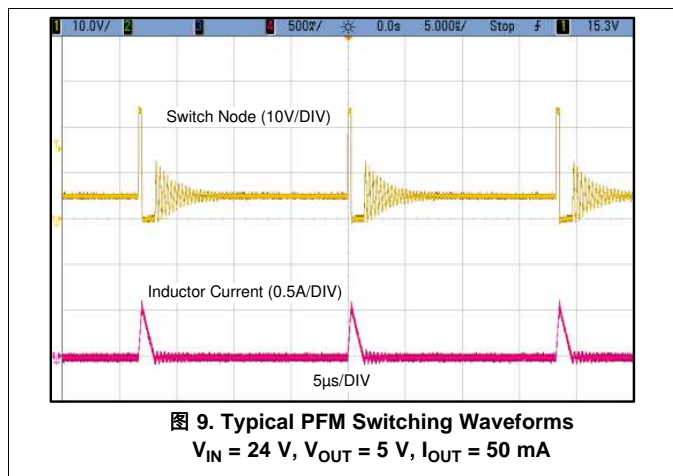

8.4.2 Forced PWM Operation

The following select variant is a factory option made available for cases when constant frequency operation is more important than light load efficiency.

表 1. LMR36520 Device Variants with Fixed Frequency Operation at No Load

ORDERABLE PART NUMBER	OUTPUT CURRENT	FPWM	$f_{sw}$
LMR36520FADDAR	2 A	Yes	400 kHz

In FPWM operation, the diode emulation feature is turned off. This means that the device remains in CCM under light loads. Under conditions where the device must reduce the on-time or off-time below the ensured minimum to maintain regulation, the frequency reduces to maintain the effective duty cycle required for regulation. This occurs for very high and very low input and output voltage ratios. In FPWM mode, a limited reverse current is allowed through the inductor, allowing power to pass from the output of the regulator to the input of the regulator. Note that in FPWM mode, larger currents pass through the inductor, if lightly loaded, than in auto mode. Once loads are heavy enough to necessitate CCM operation, FPWM mode has no measurable effect on regulator operation.

8.4.3 Dropout

The dropout performance of any buck regulator is affected by the  $R_{DS(on)}$  of the power MOSFETs, the DC resistance of the inductor, and the maximum duty cycle that the controller can achieve. As the input voltage is reduced to the output voltage, the off-time of the high-side MOSFET starts to approach the minimum value. Beyond this point, the switching can become erratic and the output voltage falls out of regulation. To avoid this problem, the LMR36520 automatically reduces the switching frequency to increase the effective duty cycle and maintain regulation. In this data sheet, the dropout voltage is defined as the difference between the input and output voltage when the output has dropped by 1% of the nominal value. Under this condition, the switching frequency has dropped to its minimum value of about 140 kHz. Note that the 0.4 V short circuit detection threshold is not activated when in dropout mode.

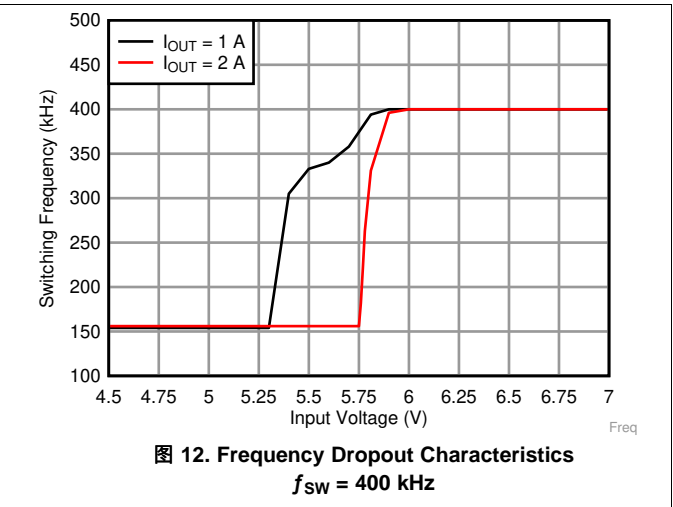
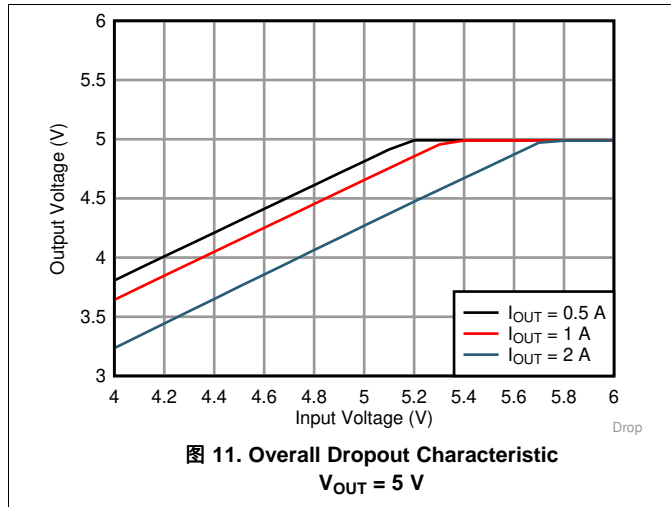

#### 8.4.4 Minimum Switch On-Time

Every switching regulator has a minimum controllable on-time dictated by the inherent delays and blanking times associated with the control circuits. This imposes a minimum switch duty cycle, therefore, a minimum conversion ratio. The constraint is encountered at high input voltages and low output voltages. To help extend the minimum controllable duty cycle, the LMR36520 automatically reduces the switching frequency when the minimum on-time limit is reached. This way, the converter can regulate the lowest programmable output voltage at the maximum input voltage. An estimate for the approximate input voltage, for a given output voltage, before frequency foldback occurs is found in [公式 2](#). As the input voltage is increased, the switch on-time (duty cycle) reduces to regulate the output voltage. When the on-time reaches the limit, the switching frequency drops, while the on-time remains fixed.

$$V_{IN} \leq \frac{V_{OUT}}{t_{ON} \cdot f_{SW}} \quad (2)$$



## 9 Application and Implementation

### 注

Information in the following applications sections is not part of the TI component specification, and TI does not warrant its accuracy or completeness. TI's customers are responsible for determining suitability of components for their purposes. Customers should validate and test their design implementation to confirm system functionality.

### 9.1 Application Information

The LMR36520 step-down DC-to-DC converter is typically used to convert a higher DC voltage to a lower DC voltage with a maximum output current of 2 A. The following design procedure can be used to select components for the LMR36520.

### 注

All of the capacitance values given in the following application information refer to *effective* values; unless otherwise stated. The *effective* value is defined as the actual capacitance under DC bias and temperature, not the rated or nameplate values. Use high-quality, low-ESR, ceramic capacitors with an X7R or better dielectric throughout. All high value ceramic capacitors have a large voltage coefficient in addition to normal tolerances and temperature effects. Under DC bias, the capacitance drops considerably. Large case sizes and higher voltage ratings are better in this regard. To help mitigate these effects, multiple capacitors can be used in parallel to bring the minimum *effective* capacitance up to the required value. This can also ease the RMS current requirements on a single capacitor. A careful study of bias and temperature variation of any capacitor bank must be made in order to ensure that the minimum value of *effective* capacitance is provided.

### 9.2 Typical Application

shows a typical application circuit for the LMR36520. This device is designed to function over a wide range of external components and system parameters. However, the internal compensation is optimized for a certain range of external inductance and output capacitance. As a quick-start guide, 图 13 provides typical component values for a range of the most common output voltages.



图 13. Example Application Circuit

Typical Application (接下页)

表 2. Typical External Component Values

$f_{sw}$ (kHz)	$V_{OUT}$ (V)	L ( $\mu$ H)	NOMINAL $C_{OUT}$ (RATED CAPACITANCE) <sup>(1)</sup>	MINIMUM $C_{OUT}$ (RATED CAPACITANCE) <sup>(2)</sup>	$R_{FBT}$ ( $\Omega$ )	$R_{FBB}$ ( $\Omega$ )	$C_{IN}$	$C_{FF}$
400	3.3	6.8	3 × 22 $\mu$ F	3 × 22 $\mu$ F	100 k	43.2 k	2 × 4.7 $\mu$ F + 220 nF	None
400	5	10	2 × 22 $\mu$ F	2 × 22 $\mu$ F	100 k	24.9 k	2 × 4.7 $\mu$ F + 220 nF	None
400	12	33	4 × 10 $\mu$ F	4 × 10 $\mu$ F	100 k	9.09 k	2 × 4.7 $\mu$ F + 220 nF	None

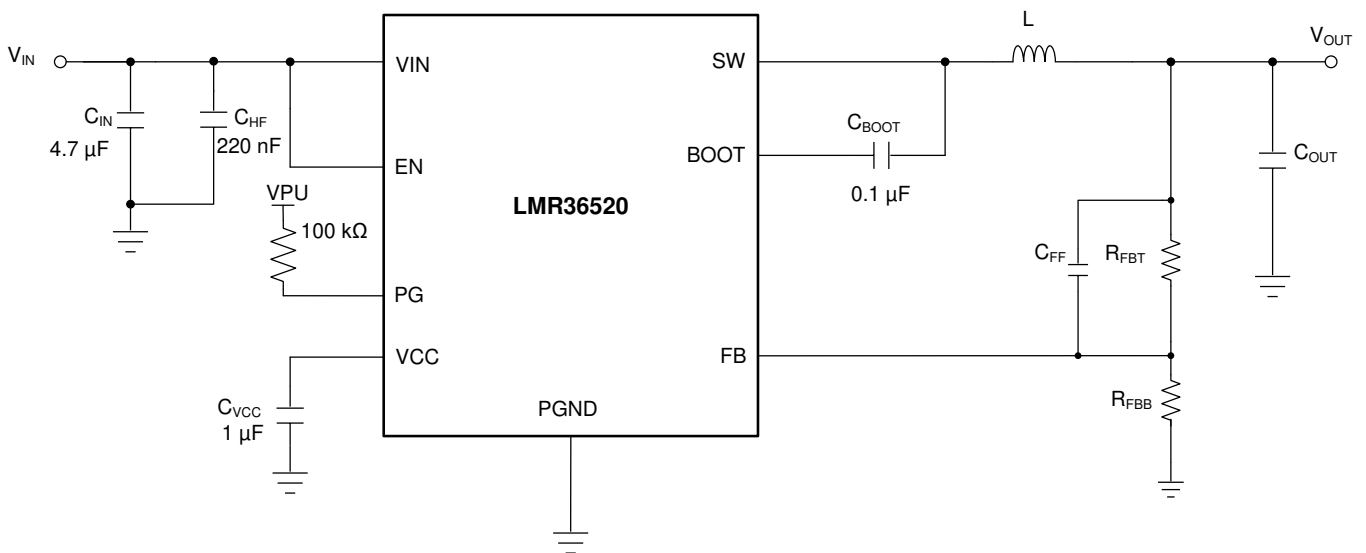
- (1) Optimized for superior load transient performance from 0 to 100% rated load.
- (2) Optimized for size constrained end applications.

9.2.1 Design 1: Low Power 24-V, 2-A Buck Converter

9.2.1.1 Design Requirements

The following are example requirements for a typical 5-V or 3.3-V application. The input voltages are here for illustration purposes only. See the [Specifications](#) for the operating input voltage range.

表 3. Detailed Design Parameters

DESIGN PARAMETER	EXAMPLE VALUE
Input voltage	12 V to 24 V steady state, 4.2 V to 60-V transients
Output voltage	5 V
Maximum output current	0 A to 2 A
Switching frequency	400 kHz
Current consumption at 0-A load	Critical: Need to ensure low current consumption to reduce battery drain
Switching frequency at 0-A load	Not critical: Need fixed frequency operation at high load only

表 4. List of Components for Design 1

$V_{OUT}$	FREQUENCY	$R_{FBB}$	$C_{OUT}$	L	U1
5 V	400 kHz	24.9 k $\Omega$	2 × 22 $\mu$ F	10 $\mu$ H	LMR36520
3.3 V	400 kHz	43.2 k $\Omega$	3 × 22 $\mu$ F	6.8 $\mu$ H	LMR36520

9.2.1.2 Detailed Design Procedure

The following design procedure applies to [图 13](#) 和 [表 3](#).

9.2.1.2.1 Choosing the Switching Frequency

The choice of switching frequency is a compromise between conversion efficiency and overall solution size. The LMR36520 switching frequency is fixed internal to the IC, therefore, a value of 400 kHz is used in this design.

9.2.1.2.2 Setting the Output Voltage

The output voltage of LMR36520 is externally adjustable using a resistor divider network. The range of recommended output voltage is found in the [Recommended Operating Conditions](#). The divider network is comprised of  $R_{FBT}$  and  $R_{FBB}$ , and closes the loop between the output voltage and the converter. The converter regulates the output voltage by holding the voltage on the FB pin equal to the internal reference voltage,  $V_{REF}$ . The resistance of the divider is a compromise between excessive noise pickup and excessive loading of the output. Smaller values of resistance reduce noise sensitivity but also reduce the light-load efficiency. The recommended value for  $R_{FBT}$  is 100 k $\Omega$  with a maximum value of 1 M $\Omega$ . If a 1 M $\Omega$  is selected for  $R_{FBT}$ , then a feedforward capacitor must be used across this resistor to provide adequate loop phase margin (see the  [\$C\_{FF}\$  Selection](#) section). Once  $R_{FBT}$  is selected, use [公式 3](#) to select  $R_{FBB}$ .  $V_{REF}$  is nominally 1 V.

$$R_{FBB} = \frac{R_{FBT}}{\left[ \frac{V_{OUT}}{V_{REF}} - 1 \right]} \tag{3}$$

For this 5-V example, values are:  $R_{FBT} = 100 \text{ k}\Omega$  and  $R_{FBB} = 24.9 \text{ k}\Omega$ .

### 9.2.1.2.3 Inductor Selection

The parameters for selecting the inductor are the inductance and saturation current. The inductance is based on the desired peak-to-peak ripple current and is normally chosen to be in the range of 20% to 40% of the maximum output current. Experience shows that the best value for inductor ripple current is 30% of the maximum load current. Note that when selecting the ripple current for applications with much smaller maximum load than the maximum available from the device, use the maximum device current. [公式 4](#) can be used to determine the value of inductance. The constant K is the percentage of inductor current ripple. This example uses  $K = 0.4$  and with input voltage of 24 V, you can calculate an inductance of  $L = 12.37 \text{ }\mu\text{H}$ . The standard value of 10  $\mu\text{H}$  is selected.

$$L = \frac{(V_{IN} - V_{OUT})}{f_{SW} \cdot K \cdot I_{OUT_{max}}} \cdot \frac{V_{OUT}}{V_{IN}} \quad (4)$$

Ideally, the saturation current rating of the inductor is at least as large as the high-side switch current limit,  $I_{SC}$ . This ensures that the inductor does not saturate even during a short circuit on the output. When the inductor core material saturates, the inductance falls to a very low value, causing the inductor current to rise very rapidly. Although the valley current limit,  $I_{LIMIT}$ , is designed to reduce the risk of current runaway, a saturated inductor can cause the current to rise to high values very rapidly. This can lead to component damage. Do not allow the inductor to saturate. Inductors with a ferrite core material have very *hard* saturation characteristics, but usually have lower core losses than powdered iron cores. Powdered iron cores exhibit a *soft* saturation, allowing some relaxation in the current rating of the inductor. However, they have more core losses at frequencies above about 1 MHz. In any case, the inductor saturation current must not be less than the device low-side current limit,  $I_{LIMIT}$ . In order to avoid subharmonic oscillation, the inductance value must not be less than that given in [公式 5](#):

$$L_{MIN} \geq M \cdot \frac{V_{OUT}}{f_{SW}}$$

where

- $L_{MIN}$  = minimum inductance (H)
- $M = 0.42$
- $f_{sw}$  = switching frequency (Hz)

(5)

### 9.2.1.2.4 Output Capacitor Selection

The value of the output capacitor and the respective ESR determine the output voltage ripple and load transient performance. The output capacitor bank is usually limited by the load transient requirements rather than the output voltage ripple. [公式 6](#) can be used to estimate a lower bound on the total output capacitance, and an upper bound on the ESR that is required to meet a specified load transient.

$$C_{OUT} \geq \frac{\Delta I_{OUT}}{f_{SW} \cdot \Delta V_{OUT} \cdot K} \cdot \left[ (1-D) \cdot (1+K) + \frac{K^2}{12} \cdot (2-D) \right]$$

$$ESR \leq \frac{(2+K) \cdot \Delta V_{OUT}}{2 \cdot \Delta I_{OUT} \left[ 1+K + \frac{K^2}{12} \cdot \left( 1 + \frac{1}{(1-D)} \right) \right]}$$

$$D = \frac{V_{OUT}}{V_{IN}}$$

where

- $\Delta V_{OUT}$  = output voltage transient
  - $\Delta I_{OUT}$  = output current transient
  - $K$  = ripple factor from [Inductor Selection](#)
- (6)

Once the output capacitor and ESR have been calculated, [公式 7](#) can be used to check the output voltage ripple.

$$V_r \cong \Delta I_L \cdot \sqrt{\text{ESR}^2 + \frac{1}{(8 \cdot f_{\text{SW}} \cdot C_{\text{OUT}})^2}}$$

where

- $V_r$  = peak-to-peak output voltage ripple (7)

The output capacitor and ESR can then be adjusted to meet both the load transient and output ripple requirements.

In practice, the output capacitor has the most influence on the transient response and loop-phase margin. Load transient testing and bode plots are the best way to validate any given design and must always be completed before the application goes into production. In addition to the required output capacitance, a small ceramic placed on the output can help reduce high frequency noise. Small case size ceramic capacitors in the range of 1 nF to 100 nF can be very helpful in reducing spikes on the output caused by inductor and board parasitics.

Limit the maximum value of total output capacitance to about 10 times the design value, or 1000  $\mu\text{F}$ , whichever is smaller. Large values of output capacitance can adversely affect the start-up behavior of the regulator as well as the loop stability. If values larger than noted here must be used, then a careful study of start-up at full load and loop stability must be performed.

#### 9.2.1.2.5 Input Capacitor Selection

The ceramic input capacitors provide a low impedance source to the regulator in addition to supplying the ripple current and isolating switching noise from other circuits. A minimum ceramic capacitance of 4.7- $\mu\text{F}$  is required on the input of the LMR36520. This must be rated for at least the maximum input voltage that the application requires; preferably twice the maximum input voltage. This capacitance can be increased to help reduce input voltage ripple and maintain the input voltage during load transients. In addition, a small case size 220-nF ceramic capacitor must be used at the input, as close as possible to the regulator. This provides a high frequency bypass for the control circuits internal to the device. For this example, a 1 x 4.7- $\mu\text{F}$ , 100-V, X7R (or better) ceramic capacitor is chosen. The 220 nF must also be rated at 100-V with an X7R dielectric.

It is often desirable to use an electrolytic capacitor on the input in parallel with the ceramics. This is especially true if long leads/traces are used to connect the input supply to the regulator. The moderate ESR of this capacitor can help damp any ringing on the input supply caused by the long power leads. The use of this additional capacitor also helps with voltage dips caused by input supplies with unusually high impedance.

Most of the input switching current passes through the ceramic input capacitors. The approximate RMS value of this current can be calculated from [公式 8](#) and must be checked against the manufacturer's maximum ratings.

$$I_{\text{RMS}} \cong \frac{I_{\text{OUT}}}{2} \quad (8)$$

#### 9.2.1.2.6 $C_{\text{BOOT}}$

The LMR36520 requires a bootstrap capacitor connected between the BOOT pin and the SW pin. This capacitor stores energy that is used to supply the gate drivers for the power MOSFETs. A high-quality ceramic capacitor of 100 nF and at least 16 V is required.

#### 9.2.1.2.7 VCC

The VCC pin is the output of the internal LDO used to supply the control circuits of the regulator. This output requires a 1- $\mu\text{F}$ , 16-V ceramic capacitor connected from VCC to GND for proper operation. In general, this output must not be loaded with any external circuitry. However, this output can be used to supply the pullup for the power-good function (see the [Power-Good Flag Output](#) section). A value in the range of 10 k $\Omega$  to 100 k $\Omega$  is a good choice in this case. The nominal output voltage on VCC is 5 V.

### 9.2.1.2.8 C<sub>FF</sub> Selection

In some cases, a feedforward capacitor can be used across R<sub>FBT</sub> to improve the load transient response or improve the loop-phase margin. This is especially true when values of R<sub>FBT</sub> > 100 kΩ are used. Large values of R<sub>FBT</sub>, in combination with the parasitic capacitance at the FB pin, can create a small signal pole that interferes with the loop stability. A C<sub>FF</sub> can help mitigate this effect. 公式 9 can be used to estimate the value of C<sub>FF</sub>. The value found with 公式 9 is a starting point; use lower values to determine if any advantage is gained by the using a C<sub>FF</sub> capacitor. The [Optimizing Transient Response of Internally Compensated DC-DC Converters with Feedforward Capacitor Application Report](#) is helpful when experimenting with a feedforward capacitor.

$$C_{FF} < \frac{V_{OUT} \cdot C_{OUT}}{120 \cdot R_{FBT} \cdot \sqrt{\frac{V_{REF}}{V_{OUT}}}} \quad (9)$$

### 9.2.1.2.9 External UVLO

In some cases, an input UVLO level different than that provided internal to the device is needed. This can be accomplished by using the circuit shown in 图 14. The input voltage at which the device turns on is designated V<sub>ON</sub> and the turnoff voltage is V<sub>OFF</sub>. First, a value for R<sub>ENB</sub> is chosen in the range of 10 kΩ to 100 kΩ and then 公式 10 is used to calculate R<sub>ENT</sub> and V<sub>OFF</sub>.



图 14. Setup for External UVLO Application

$$R_{ENT} = \left( \frac{V_{ON}}{V_{EN-H}} - 1 \right) \cdot R_{ENB}$$

$$V_{OFF} = V_{ON} \cdot \left( 1 - \frac{V_{EN-HYS}}{V_{EN}} \right)$$

where

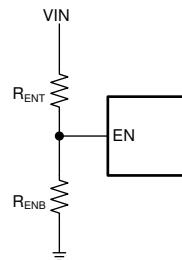
- V<sub>ON</sub> = V<sub>IN</sub> turnon voltage
- V<sub>OFF</sub> = V<sub>IN</sub> turnoff voltage

(10)

### 9.2.1.2.10 Maximum Ambient Temperature

As with any power conversion device, the LMR36520 dissipates internal power while operating. The effect of this power dissipation is to raise the internal temperature of the converter above ambient. The internal die temperature (T<sub>J</sub>) is a function of the ambient temperature, the power loss, and the effective thermal resistance, R<sub>θJA</sub>, of the device and PCB combination. The maximum internal die temperature for the LMR36520 must be limited to 150°C. This establishes a limit on the maximum device power dissipation and, therefore, the load current. 公式 11 shows the relationships between the important parameters. It is easy to see that larger ambient temperatures (T<sub>A</sub>) and larger values of R<sub>θJA</sub> reduce the maximum available output current. The converter efficiency can be estimated using the curves provided in this data sheet. If the desired operating conditions cannot be found in one of the curves, then interpolation can be used to estimate the efficiency. Alternatively, the EVM can be adjusted to match the desired application requirements and the efficiency can be measured directly. The correct value of R<sub>θJA</sub> is more difficult to estimate. As stated in the [Semiconductor and IC Package Thermal Metrics Application Report](#), the values given in [Thermal Information](#) are not valid for design purposes and must not be used to estimate the thermal performance of the application. The values reported in that table were measured under a specific set of conditions that are rarely obtained in an actual application.

$$I_{OUT}|_{MAX} = \frac{(T_J - T_A)}{R_{\theta JA}} \cdot \frac{\eta}{(1 - \eta)} \cdot \frac{1}{V_{OUT}}$$

where

- $\eta$  = efficiency

(11)

The effective  $R_{\theta JA}$  is a critical parameter and depends on many factors such as the following:

- Power dissipation
- Air temperature/flow
- PCB area
- Copper heat-sink area
- Number of thermal vias under the package
- Adjacent component placement

A typical example of  $R_{\theta JA}$  versus copper board area can be found in [图 15](#). Note that the data given in this graph is for illustration purposes only, and the actual performance in any given application depends on all of the factors mentioned above.

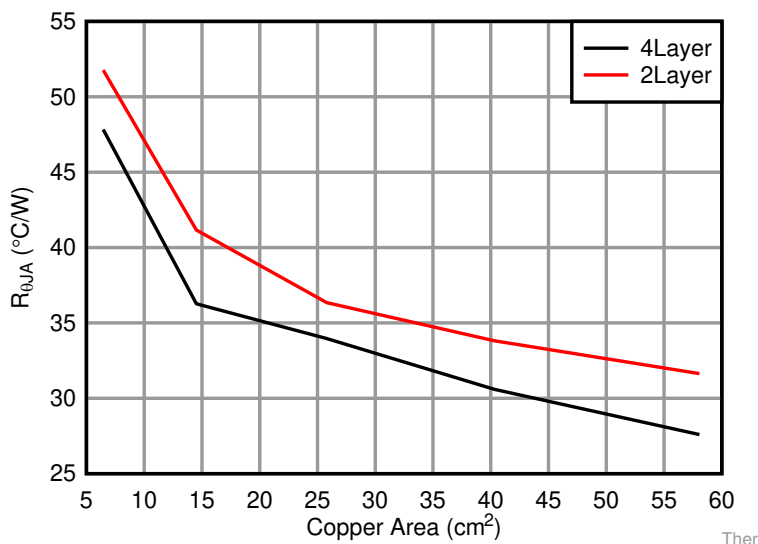

**图 15.  $R_{\theta JA}$  versus Copper Board Area**

Use the following resources as guides to optimal thermal PCB design and estimate  $R_{\theta JA}$  for a given application environment:

- [Thermal Design by Insight not Hindsight Application Report](#)
- [Semiconductor and IC Package Thermal Metrics Application Report](#)
- [Thermal Design Made Simple with LM43603 and LM43602 Application Report](#)
- [Using New Thermal Metrics Application Report](#)

### 9.2.2 Application Curves

Unless otherwise specified, the following conditions apply:  $V_{IN} = 24\text{ V}$ ,  $T_A = 25^\circ\text{C}$ . 图 32 shows the circuit with the appropriate BOM from 表 5.



图 16. Efficiency



图 17. Load Regulation

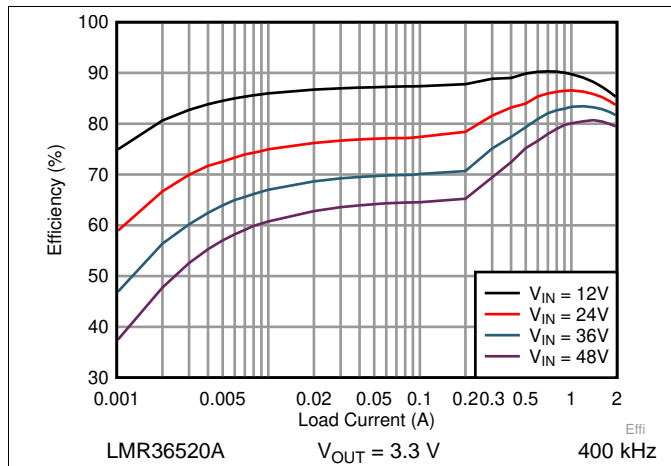

图 18. Efficiency

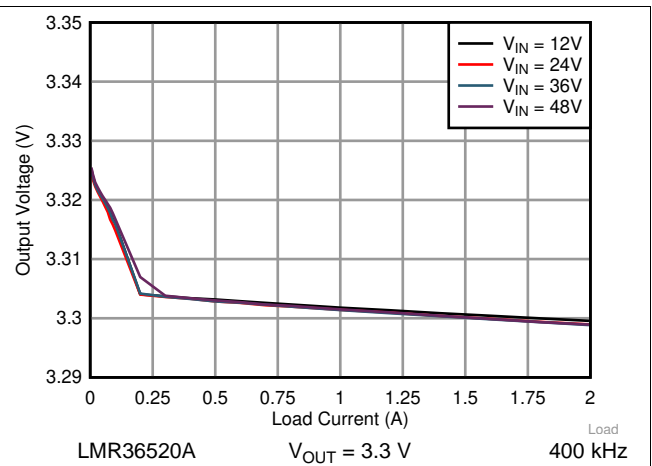

图 19. Load Regulation

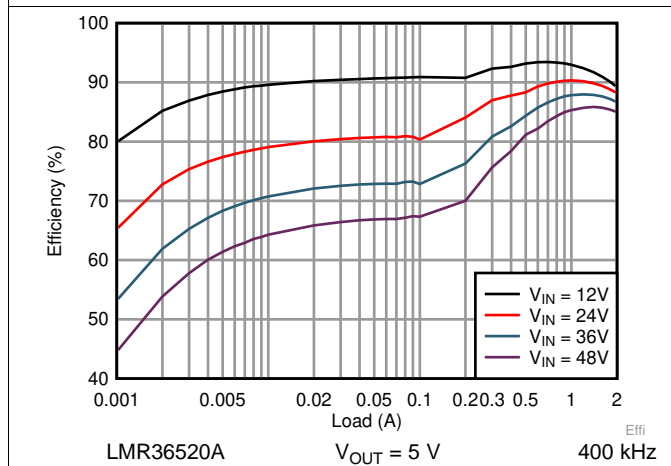

图 20. Efficiency

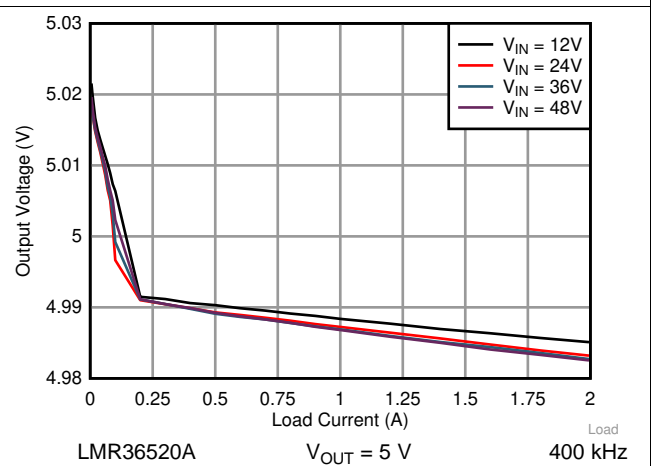

图 21. Load Regulation

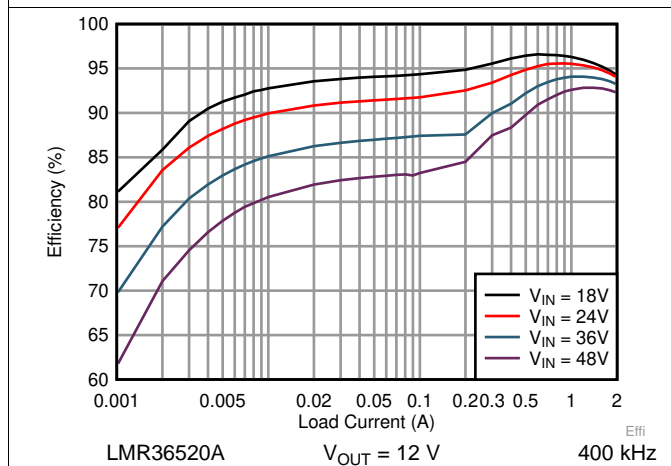

图 22. Dropout Characteristic

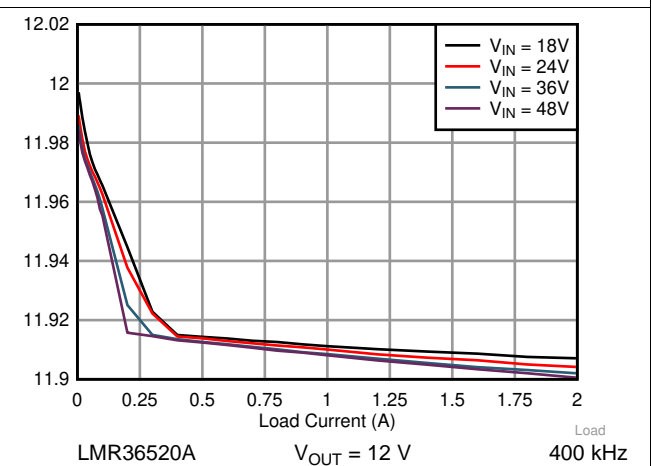

图 23. Dropout Characteristic

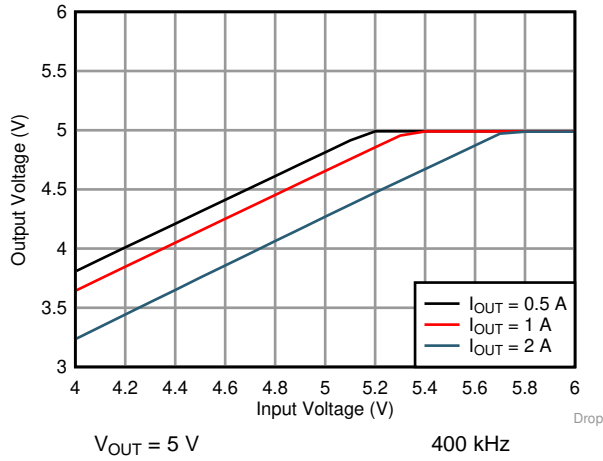

图 24. Input Supply Current

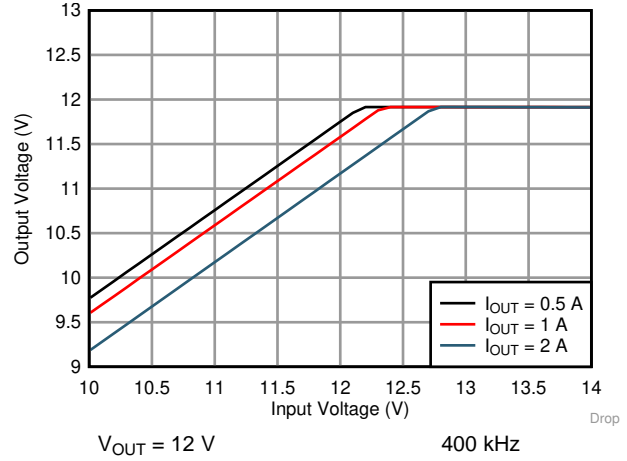

图 25. Input Supply Current versus Load Current

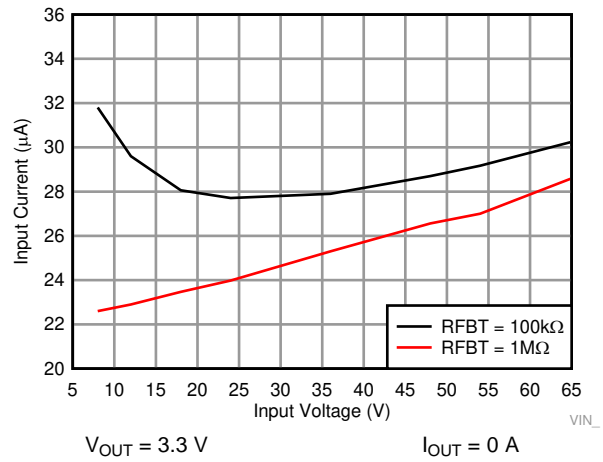

图 26. Enable Start-Up Waveform

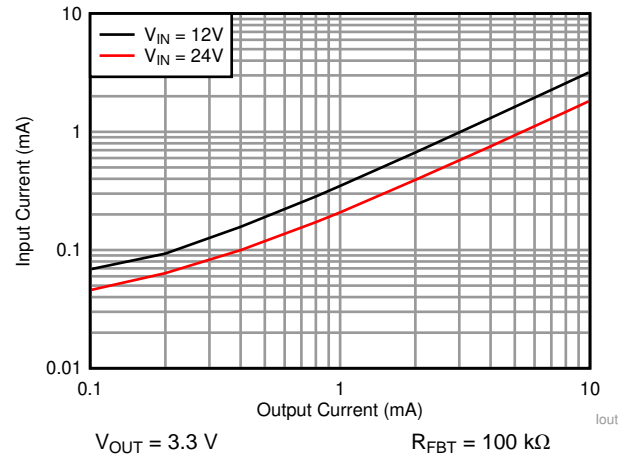

图 27. Enable Shutdown Waveform



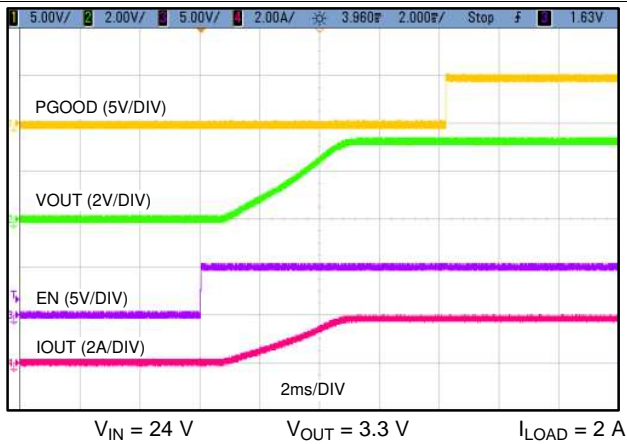

$V_{OUT} = 3.3\text{ V}$        $400\text{ kHz}$        $I_{LOAD} = 0.5\text{ A} - 2\text{ A}$   
Slew Rate =  $1\text{ A}/\mu\text{s}$

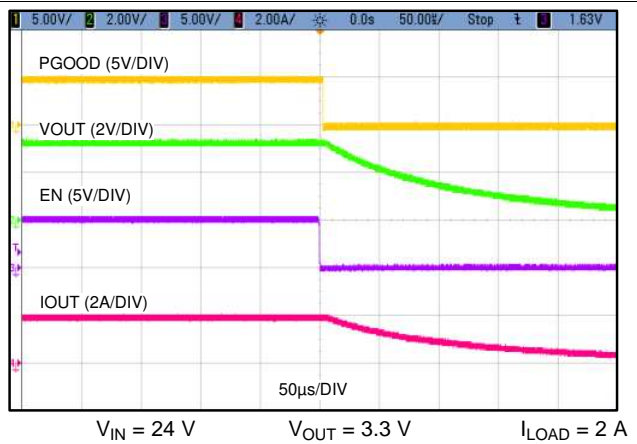
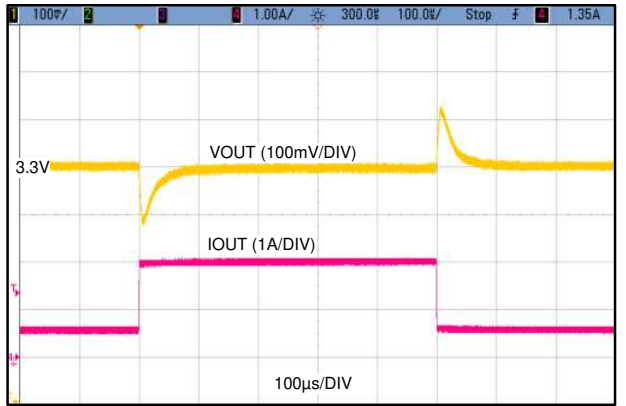
图 28. Load Transient

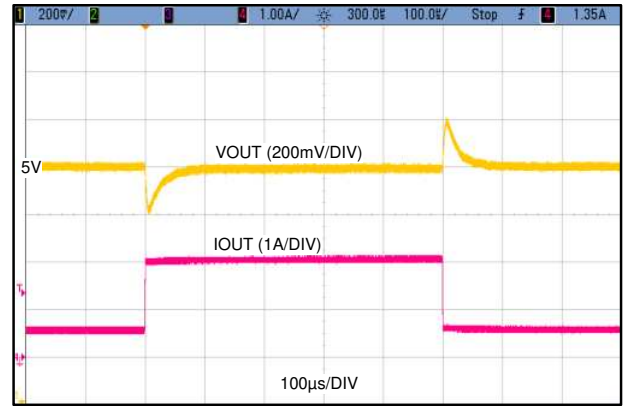

$V_{OUT} = 5\text{ V}$        $400\text{ kHz}$        $I_{LOAD} = 0.5\text{ A} - 2\text{ A}$   
Slew Rate =  $1\text{ A}/\mu\text{s}$

图 29. Load Transient

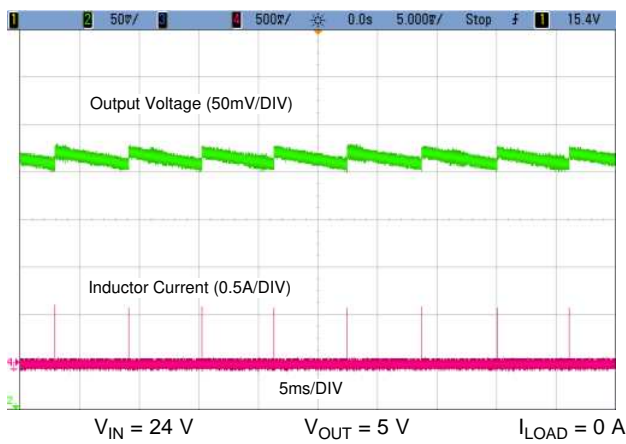

$V_{IN} = 24\text{ V}$        $V_{OUT} = 5\text{ V}$        $I_{LOAD} = 0\text{ A}$

图 30. Output Ripple at No load

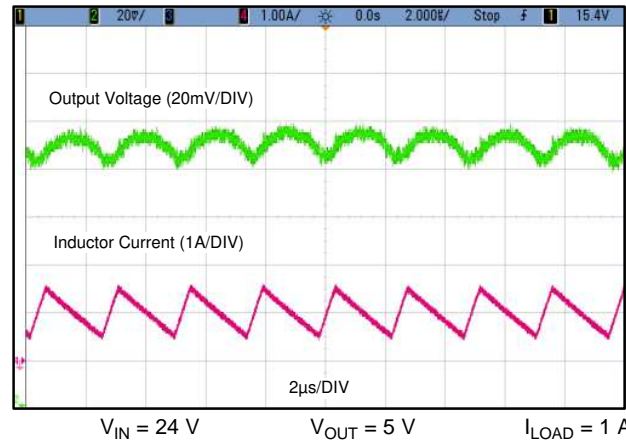

$V_{IN} = 24\text{ V}$        $V_{OUT} = 5\text{ V}$        $I_{LOAD} = 1\text{ A}$

图 31. Output Ripple at 1 A



图 32. Circuit for Typical Application Curves

表 5. BOM for Typical Application Curves

V <sub>OUT</sub>	FREQUENCY	L	C <sub>OUT</sub>	R <sub>FBT</sub>	R <sub>FBB</sub>	C <sub>FF</sub>	IC
3.3 V	400 kHz	6.8 μH, 29.45 mΩ	3 x 22 μF, 25V	46.4 kΩ	20.0 kΩ	None	LMR36520A
5 V	400 kHz	10 μH, 29.82 mΩ	2 x 22 μF, 25V	34.0 kΩ + 46.4 kΩ	20.0 kΩ	None	LMR36520A
12 V	400 kHz	33 μH, 57 mΩ	3 x 22 μF, 25V	100 kΩ	9.09 kΩ	None	LMR36520A

### 9.3 What to Do and What Not to Do

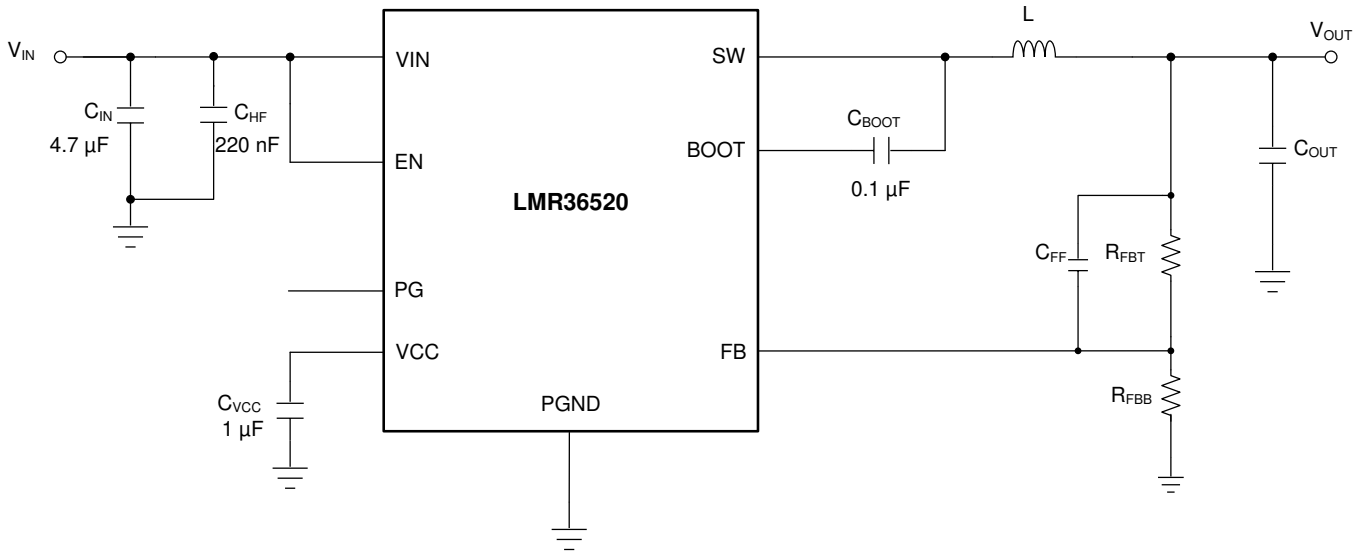
- Do not allow the EN input to float.
- Do not allow the output voltage to exceed the input voltage, nor go below ground.
- Do not use the thermal data given in the [Thermal Information](#) table to design your application.

## 10 Power Supply Recommendations

The characteristics of the input supply must be compatible with the [Specifications](#) found in this data sheet. In addition, the input supply must be capable of delivering the required input current to the loaded regulator. The average input current can be estimated with [公式 12](#).

$$I_{IN} = \frac{V_{OUT} \cdot I_{OUT}}{V_{IN} \cdot \eta}$$

where

- $\eta$  is the efficiency (12)

If the regulator is connected to the input supply through long wires or PCB traces, special care is required to achieve good performance. The parasitic inductance and resistance of the input cables can have an adverse effect on the operation of the regulator. The parasitic inductance, in combination with the low-ESR, ceramic input capacitors, can form an underdamped resonant circuit, resulting in overvoltage transients at the input to the regulator. The parasitic resistance can cause the voltage at the VIN pin to dip whenever a load transient is applied to the output. If the application is operating close to the minimum input voltage, this dip can cause the regulator to momentarily shutdown and reset. The best way to solve these kind of issues is to reduce the distance from the input supply to the regulator and use an aluminum or tantalum input capacitor in parallel with the ceramics. The moderate ESR of these types of capacitors help damp the input resonant circuit and reduce any overshoots. A value in the range of 20  $\mu$ F to 100  $\mu$ F is usually sufficient to provide input damping and help hold the input voltage steady during large load transients.

Sometimes, for other system considerations, an input filter is used in front of the regulator. This can lead to instability, as well as some of the effects mentioned above, unless it is designed carefully. The [AN-2162 Simple Success With Conducted EMI From DC/DC Converters User's Guide](#) provides helpful suggestions when designing an input filter for any switching regulator.

In some cases, a transient voltage suppressor (TVS) is used on the input of regulators. One class of this device has a *snap-back* characteristic (thyristor type). The use of a device with this type of characteristic is not recommended. When the TVS fires, the clamping voltage falls to a very low value. If this voltage is less than the output voltage of the regulator, the output capacitors discharge through the device and back into the input. This uncontrolled current flow can damage the device.

## 11 Layout

### 11.1 Layout Guidelines

The PCB layout of any DC/DC converter is critical to the optimal performance of the design. Poor PCB layout can disrupt the operation of an otherwise good schematic design. Even if the converter regulates correctly, bad PCB layout can mean the difference between a robust design and one that cannot be mass produced. Furthermore, to a great extent, the EMI performance of the regulator is dependent on the PCB layout. In a buck converter, the most critical PCB feature is the loop formed by the input capacitors and power ground, as shown in [Figure 33](#). This loop carries large transient currents that can cause large transient voltages when reacting with the trace inductance. These unwanted transient voltages disrupt the proper operation of the converter. Because of this, the traces in this loop must be wide and short, and the loop area as small as possible to reduce the parasitic inductance. [Figure 34](#) shows a recommended layout for the critical components of the LMR36520.

1. *Place the input capacitors as close as possible to the VIN and GND terminals.* VIN and GND pins are adjacent, simplifying the input capacitor placement.
2. *Place the bypass capacitor for VCC close to the VCC pin.* This capacitor must be placed close to the device and routed with short, wide traces to the VCC and GND pins.
3. *Use wide traces for the C<sub>BOOT</sub> capacitor.* Place C<sub>BOOT</sub> close to the device with short, wide traces to the BOOT and SW pins. Route the SW pin to the N/C pin and used it to connect the BOOT capacitor to SW.
4. *Place the feedback divider as close as possible to the FB pin of the device.* Place R<sub>FBB</sub>, R<sub>FBT</sub>, and C<sub>FF</sub>, if used, physically close to the device. The connections to FB and GND must be short and close to those pins on the device. The connection to V<sub>OUT</sub> can be somewhat longer. However, this latter trace must not be routed near any noise source (such as the SW node) that can capacitively couple into the feedback path of the regulator.
5. *Use at least one ground plane in one of the middle layers.* This plane acts as a noise shield and also act as a heat dissipation path.
6. *Provide wide paths for VIN, VOUT, and GND.* Making these paths as wide and direct as possible reduces any voltage drops on the input or output paths of the converter and maximizes efficiency.
7. *Provide enough PCB area for proper heat-sinking.* As stated in the [Maximum Ambient Temperature](#) section, enough copper area must be used to ensure a low R<sub>θJA</sub>, commensurate with the maximum load current and ambient temperature. The top and bottom PCB layers must be made with two ounce copper; and no less than one ounce. If the PCB design uses multiple copper layers (recommended), these thermal vias can also be connected to the inner layer heat-spreading ground planes.
8. *Keep the switch area small.* Keep the copper area connecting the SW pin to the inductor as short and wide as possible. At the same time, the total area of this node must be minimized to help reduce radiated EMI.

See the following PCB layout resources for additional important guidelines:

- [Layout Guidelines for Switching Power Supplies Application Report](#)
- [Simple Switcher PCB Layout Guidelines Application Report](#)
- [Constructing Your Power Supply- Layout Considerations Seminar](#)
- [Low Radiated EMI Layout Made Simple with LM4360x and LM4600x Application Report](#)

## Layout Guidelines (接下页)



图 33. Current Loops with Fast Edges

### 11.1.1 Ground and Thermal Considerations

As previously mentioned, TI recommends using one of the middle layers as a solid ground plane. A ground plane provides shielding for sensitive circuits and traces as well as a quiet reference potential for the control circuitry. Connect the PGND pin to the ground planes using vias next to the bypass capacitors. The PGND pin is connected directly to the source of the low-side MOSFET switch and is also connected directly to the grounds of the input and output capacitors. The PGND net contains noise at the switching frequency and can bounce due to load variations. The PGND trace, as well as the  $V_{IN}$  and  $SW$  traces, must be constrained to one side of the ground planes. The other side of the ground plane contains much less noise; use it for sensitive routes.

Use as much copper as possible for the system ground plane, on the top and bottom layers for the best heat dissipation. Use a four-layer board with the copper thickness for the four layers, starting from the top as: 2 oz / 1 oz / 1 oz / 2 oz. A four-layer board with enough copper thickness, and proper layout, provides low current conduction impedance, proper shielding, and lower thermal resistance.

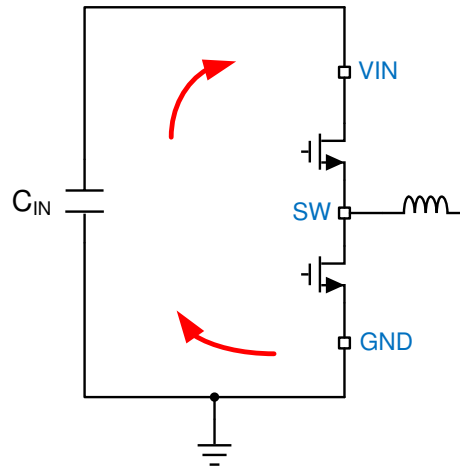
### 11.2 Layout Example



图 34. Example Layout

## 12 器件和文档支持

### 12.1 器件支持

#### 12.1.1 开发支持

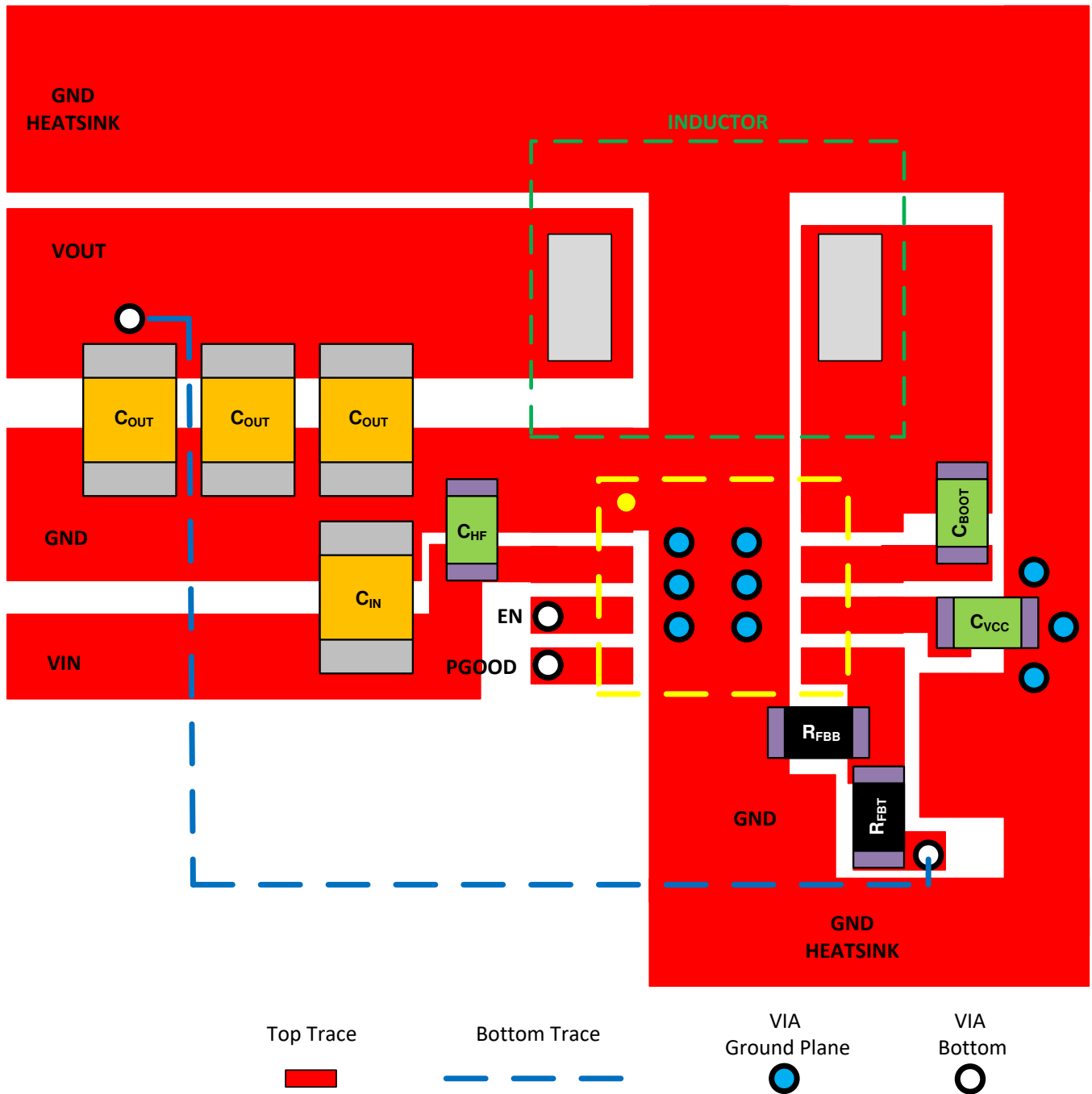
- [《直流/直流转换器封装和引脚排列设计如何提高汽车 EMI 性能》](#) 博客文章
- [降压转换器简介 特性: UVLO、启用、软启动和电源正常状态](#) 培训视频
- [降压转换器简介: 了解模式转换](#) 培训视频
- [降压转换器简介: 最小导通时间和最小关闭时间运行](#) 培训视频
- [降压转换器简介: 了解静态电流规格](#) 培训视频
- [直流/直流转换器热性能与小解决方案尺寸之间的折衷](#) 培训视频
- [利用 HotRod 封装降低 EMI 并减小解决方案尺寸](#) 培训视频

### 12.2 文档支持

#### 12.2.1 相关文档

请参阅如下相关文档:

- 德州仪器 (TI), [《设计高性能、低 EMI 的汽车电源》](#) 应用报告
- 德州仪器 (TI), [《Simple Switcher PCB 布局指南》](#) 应用报告
- 德州仪器 (TI), [《构建电源之布局注意事项》](#) 研讨会
- 德州仪器 (TI), [《使用 LM4360x 与 LM4600x 简化低辐射 EMI 布局》](#) 应用报告
- 德州仪器 (TI), [《半导体和 IC 封装热指标》](#) 应用报告
- 德州仪器 (TI), [《通过 LM43603 和 LM43602 简化热设计》](#) 应用报告

### 12.3 接收文档更新通知

要接收文档更新通知, 请导航至 [ti.com.cn](http://ti.com.cn) 上的器件产品文件夹。单击右上角的通知我进行注册, 即可每周接收产品信息更改摘要。有关更改的详细信息, 请查看任何已修订文档中包含的修订历史记录。

### 12.4 支持资源

TI E2E™ support forums are an engineer's go-to source for fast, verified answers and design help — straight from the experts. Search existing answers or ask your own question to get the quick design help you need.

Linked content is provided "AS IS" by the respective contributors. They do not constitute TI specifications and do not necessarily reflect TI's views; see TI's [Terms of Use](#).

### 12.5 商标

E2E is a trademark of Texas Instruments.

SIMPLE SWITCHER is a registered trademark of Texas Instruments.

All other trademarks are the property of their respective owners.

### 12.6 静电放电警告



这些装置包含有限的内置 ESD 保护。存储或装卸时, 应将导线一起截短或将装置放置于导电泡棉中, 以防止 MOS 门极遭受静电损伤。

### 12.7 Glossary

[SLYZ022](#) — TI Glossary.

This glossary lists and explains terms, acronyms, and definitions.

## 13 机械、封装和可订购信息

以下页面包含机械、封装和可订购信息。这些信息是指定器件的最新可用数据。数据如有变更, 恕不另行通知, 且不会对此文档进行修订。如需获取此数据表的浏览器版本, 请查阅左侧的导航栏。

## 重要声明和免责声明

TI 均以“原样”提供技术性数据（包括数据表）、设计资源（包括参考设计）、应用或其他设计建议、网络工具、安全信息和其他资源，不保证其中不含任何瑕疵，且不做任何明示或暗示的担保，包括但不限于对适销性、适合某特定用途或不侵犯任何第三方知识产权的暗示担保。

所述资源可供专业开发人员应用TI 产品进行设计使用。您将对以下行为独自承担全部责任：(1) 针对您的应用选择合适的TI 产品；(2) 设计、验证并测试您的应用；(3) 确保您的应用满足相应标准以及任何其他安全、安保或其他要求。所述资源如有变更，恕不另行通知。TI 对您使用所述资源的授权仅限于开发资源所涉及TI 产品的相关应用。除此之外不得复制或展示所述资源，也不提供其它TI 或任何第三方的知识产权授权许可。如因使用所述资源而产生任何索赔、赔偿、成本、损失及债务等，TI 对此概不负责，并且您须赔偿由此对TI 及其代表造成的损害。

TI 所提供产品均受TI 的销售条款 (<http://www.ti.com.cn/zh-cn/legal/termsofsale.html>) 以及ti.com.cn上或随附TI产品提供的其他可适用条款的约束。TI提供所述资源并不扩展或以其他方式更改TI 针对TI 产品所发布的可适用的担保范围或担保免责声明。

邮寄地址：上海市浦东新区世纪大道 1568 号中建大厦 32 楼，邮政编码：200122  
Copyright © 2020 德州仪器半导体技术（上海）有限公司



**PACKAGING INFORMATION**

Orderable Device	Status (1)	Package Type	Package Drawing	Pins	Package Qty	Eco Plan (2)	Lead finish/ Ball material (6)	MSL Peak Temp (3)	Op Temp (°C)	Device Marking (4/5)	Samples
LMR36520ADDAR	ACTIVE	SO PowerPAD	DDA	8	2500	RoHS & Green	NIPDAUAG	Level-2-260C-1 YEAR	-40 to 125	36520A	<a href="#">Samples</a>
LMR36520FADDAR	ACTIVE	SO PowerPAD	DDA	8	2500	RoHS & Green	NIPDAUAG	Level-2-260C-1 YEAR	-40 to 125	36520F	<a href="#">Samples</a>

(1) The marketing status values are defined as follows:

**ACTIVE:** Product device recommended for new designs.

**LIFEBUY:** TI has announced that the device will be discontinued, and a lifetime-buy period is in effect.

**NRND:** Not recommended for new designs. Device is in production to support existing customers, but TI does not recommend using this part in a new design.

**PREVIEW:** Device has been announced but is not in production. Samples may or may not be available.

**OBSELETE:** TI has discontinued the production of the device.

(2) **RoHS:** TI defines "RoHS" to mean semiconductor products that are compliant with the current EU RoHS requirements for all 10 RoHS substances, including the requirement that RoHS substance do not exceed 0.1% by weight in homogeneous materials. Where designed to be soldered at high temperatures, "RoHS" products are suitable for use in specified lead-free processes. TI may reference these types of products as "Pb-Free".

**RoHS Exempt:** TI defines "RoHS Exempt" to mean products that contain lead but are compliant with EU RoHS pursuant to a specific EU RoHS exemption.

**Green:** TI defines "Green" to mean the content of Chlorine (Cl) and Bromine (Br) based flame retardants meet JS709B low halogen requirements of <=1000ppm threshold. Antimony trioxide based flame retardants must also meet the <=1000ppm threshold requirement.

(3) MSL, Peak Temp. - The Moisture Sensitivity Level rating according to the JEDEC industry standard classifications, and peak solder temperature.

(4) There may be additional marking, which relates to the logo, the lot trace code information, or the environmental category on the device.

(5) Multiple Device Markings will be inside parentheses. Only one Device Marking contained in parentheses and separated by a "~" will appear on a device. If a line is indented then it is a continuation of the previous line and the two combined represent the entire Device Marking for that device.

(6) Lead finish/Ball material - Orderable Devices may have multiple material finish options. Finish options are separated by a vertical ruled line. Lead finish/Ball material values may wrap to two lines if the finish value exceeds the maximum column width.

**Important Information and Disclaimer:**The information provided on this page represents TI's knowledge and belief as of the date that it is provided. TI bases its knowledge and belief on information provided by third parties, and makes no representation or warranty as to the accuracy of such information. Efforts are underway to better integrate information from third parties. TI has taken and continues to take reasonable steps to provide representative and accurate information but may not have conducted destructive testing or chemical analysis on incoming materials and chemicals. TI and TI suppliers consider certain information to be proprietary, and thus CAS numbers and other limited information may not be available for release.

In no event shall TI's liability arising out of such information exceed the total purchase price of the TI part(s) at issue in this document sold by TI to Customer on an annual basis.



**TAPE AND REEL INFORMATION**

**QUADRANT ASSIGNMENTS FOR PIN 1 ORIENTATION IN TAPE**

\*All dimensions are nominal

Device	Package Type	Package Drawing	Pins	SPQ	Reel Diameter (mm)	Reel Width W1 (mm)	A0 (mm)	B0 (mm)	K0 (mm)	P1 (mm)	W (mm)	Pin1 Quadrant
LMR36520ADDAR	SO Power PAD	DDA	8	2500	330.0	12.8	6.4	5.2	2.1	8.0	12.0	Q1
LMR36520FADDAR	SO Power PAD	DDA	8	2500	330.0	12.8	6.4	5.2	2.1	8.0	12.0	Q1

**TAPE AND REEL BOX DIMENSIONS**

\*All dimensions are nominal

Device	Package Type	Package Drawing	Pins	SPQ	Length (mm)	Width (mm)	Height (mm)
LMR36520ADDAR	SO PowerPAD	DDA	8	2500	366.0	364.0	50.0
LMR36520FADDAR	SO PowerPAD	DDA	8	2500	366.0	364.0	50.0

DDA (R-PDSO-G8)

PowerPAD™ PLASTIC SMALL-OUTLINE



4202561/F 12/11

- NOTES:
- A. All linear dimensions are in millimeters. Dimensioning and tolerancing per ASME Y14.5-1994.
  - B. This drawing is subject to change without notice.
  - C. Body dimensions do not include mold flash or protrusion not to exceed 0,15.
  - D. This package is designed to be soldered to a thermal pad on the board. Refer to Technical Brief, PowerPad Thermally Enhanced Package, Texas Instruments Literature No. SLMA002 for information regarding recommended board layout. This document is available at [www.ti.com](http://www.ti.com) <<http://www.ti.com>>.
  - E. See the additional figure in the Product Data Sheet for details regarding the exposed thermal pad features and dimensions.
  - F. This package complies to JEDEC MS-012 variation BA

PowerPAD is a trademark of Texas Instruments.

DDA (R-PDSO-G8)

PowerPAD™ PLASTIC SMALL OUTLINE

## THERMAL INFORMATION

This PowerPAD™ package incorporates an exposed thermal pad that is designed to be attached to a printed circuit board (PCB). The thermal pad must be soldered directly to the PCB. After soldering, the PCB can be used as a heatsink. In addition, through the use of thermal vias, the thermal pad can be attached directly to the appropriate copper plane shown in the electrical schematic for the device, or alternatively, can be attached to a special heatsink structure designed into the PCB. This design optimizes the heat transfer from the integrated circuit (IC).

For additional information on the PowerPAD package and how to take advantage of its heat dissipating abilities, refer to Technical Brief, PowerPAD Thermally Enhanced Package, Texas Instruments Literature No. SLMA002 and Application Brief, PowerPAD Made Easy, Texas Instruments Literature No. SLMA004. Both documents are available at [www.ti.com](http://www.ti.com).

The exposed thermal pad dimensions for this package are shown in the following illustration.



Exposed Thermal Pad Dimensions

4206322-6/L 05/12

NOTE: A. All linear dimensions are in millimeters

PowerPAD is a trademark of Texas Instruments



- NOTES:
- A. All linear dimensions are in millimeters.
  - B. This drawing is subject to change without notice.
  - C. Publication IPC-7351 is recommended for alternate designs.
  - D. This package is designed to be soldered to a thermal pad on the board. Refer to Technical Brief, PowerPad Thermally Enhanced Package, Texas Instruments Literature No. SLMA002, SLMA004, and also the Product Data Sheets for specific thermal information, via requirements, and recommended board layout. These documents are available at [www.ti.com](http://www.ti.com) <<http://www.ti.com>>. Publication IPC-7351 is recommended for alternate designs.
  - E. Laser cutting apertures with trapezoidal walls and also rounding corners will offer better paste release. Customers should contact their board assembly site for stencil design recommendations. Example stencil design based on a 50% volumetric metal load solder paste. Refer to IPC-7525 for other stencil recommendations.
  - F. Customers should contact their board fabrication site for solder mask tolerances between and around signal pads.

PowerPAD is a trademark of Texas Instruments.

## 重要声明和免责声明

TI 均以“原样”提供技术性及其可靠性数据（包括数据表）、设计资源（包括参考设计）、应用或其他设计建议、网络工具、安全信息和其他资源，不保证其中不含任何瑕疵，且不做任何明示或暗示的担保，包括但不限于对适销性、适合某特定用途或不侵犯任何第三方知识产权的暗示担保。

所述资源可供专业开发人员应用TI 产品进行设计使用。您将对以下行为独自承担全部责任：(1) 针对您的应用选择合适的TI 产品；(2) 设计、验证并测试您的应用；(3) 确保您的应用满足相应标准以及任何其他安全、安保或其他要求。所述资源如有变更，恕不另行通知。TI 对您使用所述资源的授权仅限于开发资源所涉及TI 产品的相关应用。除此之外不得复制或展示所述资源，也不提供其它TI 或任何第三方的知识产权授权许可。如因使用所述资源而产生任何索赔、赔偿、成本、损失及债务等，TI 对此概不负责，并且您须赔偿由此对TI 及其代表造成的损害。

TI 所提供产品均受TI 的销售条款 (<http://www.ti.com.cn/zh-cn/legal/termsofsale.html>) 以及 [ti.com.cn](http://www.ti.com.cn) 上或随附TI 产品提供的其他可适用条款的约束。TI 提供所述资源并不扩展或以其他方式更改TI 针对TI 产品所发布的可适用的担保范围或担保免责声明。

邮寄地址：上海市浦东新区世纪大道 1568 号中建大厦 32 楼，邮政编码：200122  
Copyright © 2020 德州仪器半导体技术（上海）有限公司