

LP5990 Micropower 200mA CMOS Low Dropout Voltage Regulator

Check for Samples: [LP5990](#)

FEATURES

- Operation from 2.2V to 5.5V Input
- $\pm 1\%$ Accuracy Over Temp Range
- Output Voltage from 0.8V to 3.6V in 50mV Increments
- 30 μA Quiescent Current (Enabled)
- 10nA Quiescent Current (Disabled)
- 160mV Dropout at 200mA Load
- 60 μV_{RMS} Output Voltage Noise
- 60 μs Start-Up Time
- 500 μs Shut-Down Time
- PSRR 55 dB at 10 kHz
- Stable with 0402 1.0 μF Ceramic Capacitors
- Logic Controlled Enable
- Thermal-Overload and Short-Circuit Protection

APPLICATIONS

- Cellular Phones
- Hand-Held Information Appliances

PACKAGE

- 4-Bump DSBGA, 0.4 mm Pitch 866 μm x 917 μm (Lead Free)

TYPICAL APPLICATION CIRCUIT

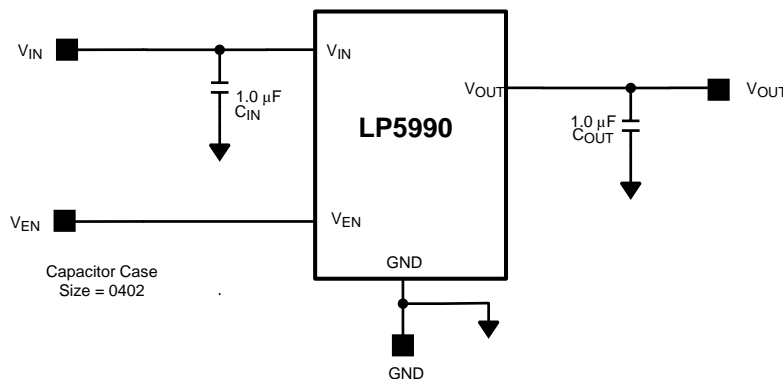

DESCRIPTION

The LP5990 regulator is designed to meet the requirements of portable, battery-powered systems providing an accurate output voltage, low noise and low quiescent current.

The LP5990 will provide a 1.8V output from a low input voltage of 2.2V and can provide 200mA to an external load.

When switched into shutdown mode via a logic signal at the enable pin, the power consumption is reduced to virtually

zero.

Fast shut-down is achieved by the push pull architecture.

The LP5990 is designed to be stable with space saving 0402 ceramic capacitors as small as 1 μF , this gives an overall solution size of < 2.5mm².

Performance is specified for a -40°C to 125°C junction temperature range.

The device is available in DSBGA Package (0.4mm pitch) and is available with 1.2V, 1.3V, 1.8V, 2.8V, 3.0V, 3.3V and 3.6V outputs. Lower voltage options down to 0.8V are available on request. For all other output voltage options please contact your local TI sales office.



Please be aware that an important notice concerning availability, standard warranty, and use in critical applications of Texas Instruments semiconductor products and disclaimers thereto appears at the end of this data sheet.

All trademarks are the property of their respective owners.

CONNECTION DIAGRAMS

**Figure 1. 4-Bump Thin DSBGA Package, 0.4mm pitch
Package Number YFQ0004CEA**

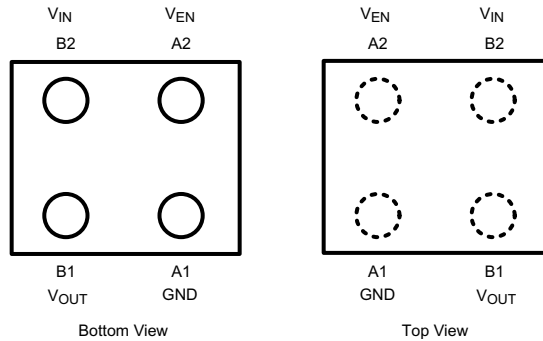

The actual physical placement of the package marking will vary from part to part.

PIN DESCRIPTIONS

Pin No.	Symbol	Name and Function
DSBGA		
A2	V _{EN}	Enable input; disables the regulator when ≤ 0.35V. Enables the regulator when ≥ 1.0V.
A1	GND	Common ground.
B1	V _{OUT}	Output voltage. A 1.0 μF Low ESR capacitor should be connected to this Pin. Connect this output to the load circuit.
B2	V _{IN}	Input voltage supply. A 1.0 μF capacitor should be connected at this input.



These devices have limited built-in ESD protection. The leads should be shorted together or the device placed in conductive foam during storage or handling to prevent electrostatic damage to the MOS gates.

ABSOLUTE MAXIMUM RATINGS (1)(2)(3)

V _{IN} Pin: Input Voltage	-0.3 to 6.0V	
V _{OUT} Pin: Output Voltage	-0.3 to (V _{IN} + 0.3V) to 6.0V (max)	
V _{EN} Pin: Enable Input Voltage	-0.3 to 6.0V (max)	
Continuous Power Dissipation (4)	Internally Limited	
Junction Temperature (T _{JMAX})	150°C	
Storage Temperature Range	-65 to 150°C	
Maximum Lead Temperature (Soldering, 10 sec.)	260°C	
ESD Rating (5)	Human Body Model	2 kV
	Machine Model	200V

- (1) Absolute Maximum Ratings indicate limits beyond which damage to the component may occur. Operating Ratings are conditions under which operation of the device is specified. Operating Ratings do not imply specified performance limits. For specified performance limits and associated test conditions, see the Electrical Characteristics tables.
- (2) All voltages are with respect to the potential at the GND pin.
- (3) If Military/Aerospace specified devices are required, please contact the Texas Instruments Sales Office/ Distributors for availability and specifications.
- (4) Internal thermal shutdown circuitry protects the device from permanent damage.
- (5) The Human body model is a 100 pF capacitor discharged through a 1.5 kΩ resistor into each pin. The machine model is a 200 pF capacitor discharged directly into each pin. MIL-STD-883 3015.7

OPERATING RATINGS ^{(1), (2)}

V_{IN} : Input Voltage Range	2.2V to 5.5V
V_{EN} : Enable Voltage Range	0 to 5.5V (max)
Recommended Load Current ⁽³⁾	0 to 200 mA
Junction Temperature Range (T_J)	-40°C to +125°C
Ambient Temperature Range (T_A) ⁽³⁾	-40°C to +85°C

- (1) Absolute Maximum Ratings indicate limits beyond which damage to the component may occur. Operating Ratings are conditions under which operation of the device is specified. Operating Ratings do not imply specified performance limits. For specified performance limits and associated test conditions, see the Electrical Characteristics tables.
- (2) All voltages are with respect to the potential at the GND pin.
- (3) In applications where high power dissipation and/or poor package thermal resistance is present, the maximum ambient temperature may have to be derated. Maximum ambient temperature (T_{A-MAX}) is dependent on the maximum operating junction temperature ($T_{J-MAX-OP} = 125^\circ\text{C}$), the maximum power dissipation of the device in the application (P_{D-MAX}), and the junction-to ambient thermal resistance of the part/package in the application (θ_{JA}), as given by the following equation: $T_{A-MAX} = T_{J-MAX-OP} - (\theta_{JA} \times P_{D-MAX})$. See [applications](#) section.

THERMAL PROPERTIES

Junction to Ambient Thermal Resistance θ_{JA} ⁽¹⁾	JEDEC Board (DSBGA) ⁽²⁾	100.6°C/W
	4L Cellphone Board (DSBGA)	174.8°C/W

- (1) Junction-to-ambient thermal resistance is highly application and board-layout dependent. In applications where high maximum power dissipation exists, special care must be paid to thermal dissipation issues in board design.
- (2) Detailed description of the board can be found in JESD51-7

ELECTRICAL CHARACTERISTICS

Limits in standard typeface are for $T_A = 25^\circ\text{C}$. Limits in **boldface** type apply over the full operating junction temperature range (-40°C $\leq T_J \leq +125^\circ\text{C}$). Unless otherwise noted, specifications apply to the LP5990 Typical Application Circuit (pg. 1) with: $V_{IN} = V_{OUT(NOM)} + 1.0\text{V}$, or 2.2V, whichever is higher. $V_{EN} = 1.0\text{V}$, $C_{IN} = C_{OUT} = 1.0 \mu\text{F}$, $I_{OUT} = 1.0 \text{mA}$. ^{(1), (2)}

Symbol	Parameter	Conditions	Min	Typ	Max	Units
V_{IN}	Input Voltage		2.2		5.5	V
ΔV_{OUT}	Output Voltage Tolerance	$V_{IN} = (V_{OUT(NOM)} + 1.0\text{V})$ to 5.5V	-1		1	%
	Line Regulation	$V_{IN} = (V_{OUT(NOM)} + 1.0\text{V})$ to 5.5V, $I_{OUT} = 1 \text{mA}$		1		mV
	Load Regulation	$I_{OUT} = 1 \text{mA}$ to 200 mA		5	15	mV
I_{LOAD}	Load Current	See ⁽³⁾	0			mA
	Maximum Output Current		200			
I_Q	Quiescent Current ⁽⁴⁾	$V_{EN} = 1.0\text{V}$, $I_{OUT} = 0 \text{mA}$		30	75	μA
		$V_{EN} = 1.0\text{V}$, $I_{OUT} = 200 \text{mA}$		35		
		$V_{EN} = <0.35\text{V}$ (Disabled)		0.01		
V_{DO}	Dropout Voltage ⁽⁵⁾	$I_{OUT} = 200 \text{mA}$		160	250	mV
I_{SC}	Short Circuit Current Limit	See ⁽⁶⁾		600		mA
PSRR	Power Supply Rejection Ratio ⁽⁷⁾	$f = 10 \text{kHz}$, $I_{OUT} = 200 \text{mA}$		55		dB
e_n	Output Noise Voltage ⁽⁷⁾	BW = 10 Hz to 100 kHz, $V_{IN} = 4.2\text{V}$, $I_{OUT} = 1 \text{mA}$	$V_{OUT} = 1.8\text{V}$		60	μV_{RMS}
			$V_{OUT} = 2.8\text{V}$		85	
$T_{SHUTDOWN}$	Thermal Shutdown	Temperature		160		°C
		Hysteresis		20		
Enable Input Thresholds						
V_{IL}	Low Input Threshold (V_{EN})	$V_{IN} = 2.2\text{V}$ to 5.5V			0.35	V

- (1) All voltages are with respect to the potential at the GND pin.
- (2) Min and Max limits are specified by design, test, or statistical analysis. Typical numbers are not specified, but do represent the most likely norm.
- (3) The device maintains a stable, regulated output voltage without a load current.
- (4) Quiescent current is defined here as the difference in current between the input voltage source and the load at V_{OUT} .
- (5) Dropout voltage is the voltage difference between the input and the output at which the output voltage drops to 100 mV below its nominal value. This parameter only applies to output voltages above 2.8V.
- (6) Short Circuit Current is measured with V_{OUT} pulled to 0V.
- (7) This specification is ensured by design.

ELECTRICAL CHARACTERISTICS (continued)

Limits in standard typeface are for $T_A = 25^\circ\text{C}$. Limits in **boldface** type apply over the full operating junction temperature range ($-40^\circ\text{C} \leq T_J \leq +125^\circ\text{C}$). Unless otherwise noted, specifications apply to the LP5990 Typical Application Circuit (pg. 1) with: $V_{IN} = V_{OUT(NOM)} + 1.0\text{V}$, or 2.2V , whichever is higher. $V_{EN} = 1.0\text{V}$, $C_{IN} = C_{OUT} = 1.0\ \mu\text{F}$, $I_{OUT} = 1.0\ \text{mA}$. ^{(1), (2)}

Symbol	Parameter	Conditions	Min	Typ	Max	Units
V_{IH}	High Input Threshold (V_{EN})	$V_{IN} = 2.2\text{V to } 5.5\text{V}$	1.0			V
I_{EN}	Input Current at V_{EN} Pin ⁽⁸⁾	$V_{EN} = 5.5\text{V}$ and $V_{IN} = 5.5\text{V}$		2	5	μA
		$V_{EN} = 0.0\text{V}$ and $V_{IN} = 5.5\text{V}$		0.001		
Transient Characteristics						
ΔV_{OUT}	Line Transient ⁽⁷⁾	$T_{rise} = T_{fall} = 30\ \mu\text{s}$. $\Delta V_{IN} = 600\ \text{mV}$		4		mV
	Load Transient ⁽⁷⁾	$I_{OUT} = 1\ \text{mA to } 200\ \text{mA}$ in $1\ \mu\text{s}$		-50		mV
		$I_{OUT} = 200\ \text{mA to } 1\ \text{mA}$ in $1\ \mu\text{s}$			50	
T_{ON}	Turn on Time	To 98% of $V_{OUT(NOM)}$		60		μs
T_{OFF}	Turn off Time from Enable	100mV of $V_{OUT(NOM)}$ $I_{OUT} = 0\ \text{mA}$		500		μs

(8) There is a $3\ \text{M}\Omega$ resistor between V_{EN} and ground on the device.

OUTPUT & INPUT CAPACITOR, RECOMMENDED SPECIFICATIONS ⁽¹⁾

Symbol	Parameter	Conditions	Min	Nom	Max	Units
C_{IN}	Input Capacitance	Capacitance for stability	0.3	1.0		μF
C_{OUT}	Output Capacitance		0.3	1.0	10	
ESR	Output/Input Capacitance		5		500	m Ω

(1) The minimum capacitance should be greater than $0.3\ \mu\text{F}$ over the full range of operating conditions. The capacitor tolerance should be 30% or better over the full temperature range. The full range of operating conditions for the capacitor in the application should be considered during device selection to ensure this minimum capacitance specification is met. X7R capacitors are recommended however capacitor types X5R, Y5V and Z5U may be used with consideration of the application and conditions.

TYPICAL PERFORMANCE CHARACTERISTICS

Unless otherwise specified, $C_{IN} = C_{OUT} = 1.0\mu F$, $V_{IN} = V_{OUT(NOM)} + 1.0V$, $V_{EN} = 1.0V$, $I_{OUT} = 1mA$, $T_A = 25^\circ C$.

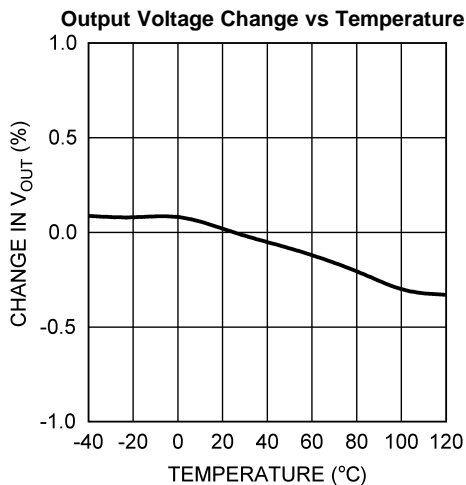

Figure 2.

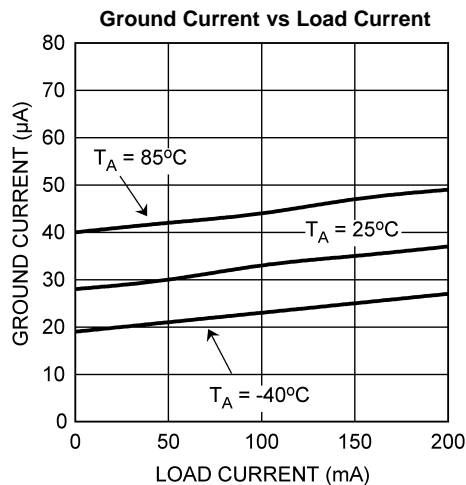

Figure 3.

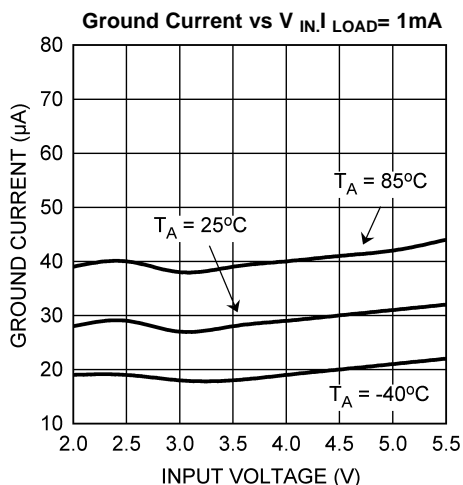

Figure 4.

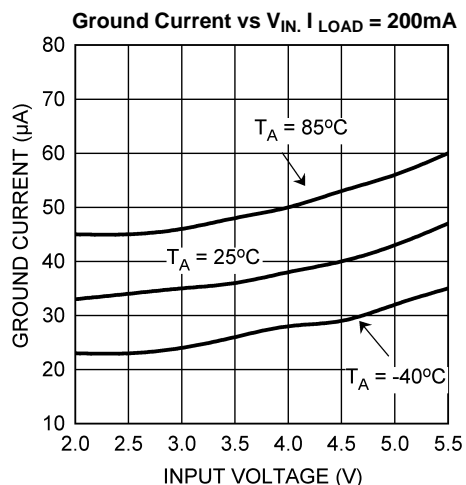

Figure 5.

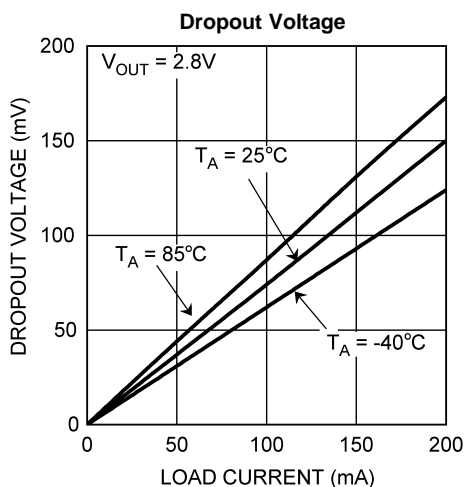

Figure 6.

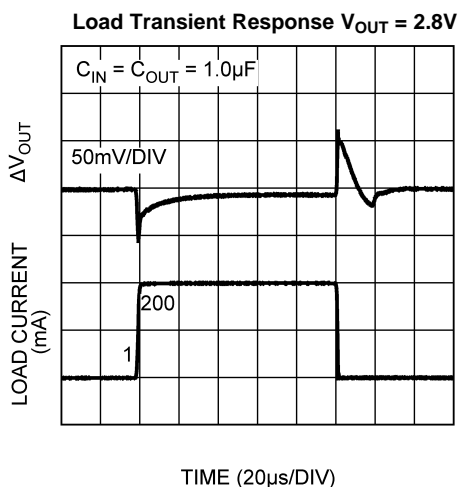

Figure 7.

TYPICAL PERFORMANCE CHARACTERISTICS (continued)

Unless otherwise specified, $C_{IN} = C_{OUT} = 1.0\mu F$, $V_{IN} = V_{OUT(NOM)} + 1.0V$, $V_{EN} = 1.0V$, $I_{OUT} = 1mA$, $T_A = 25^\circ C$.

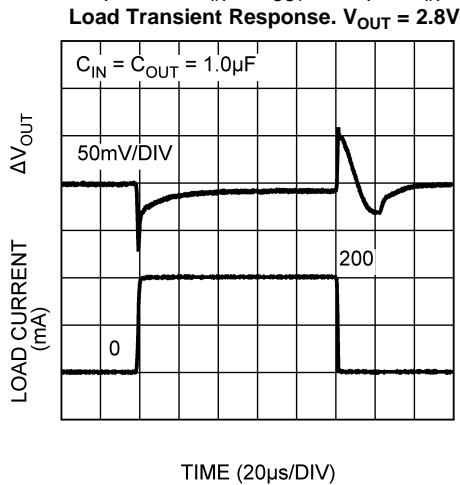

Figure 8.

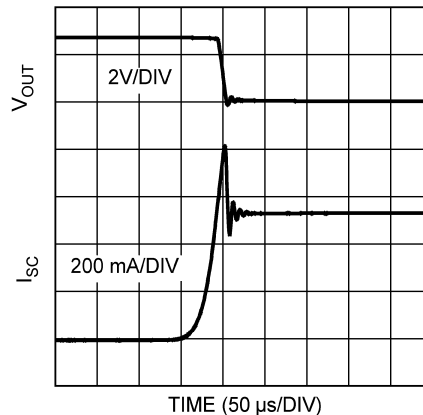

Figure 9.

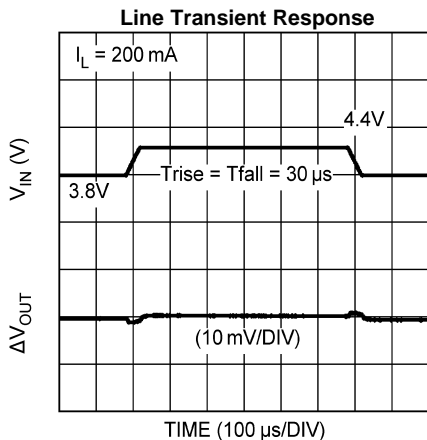

Figure 10.

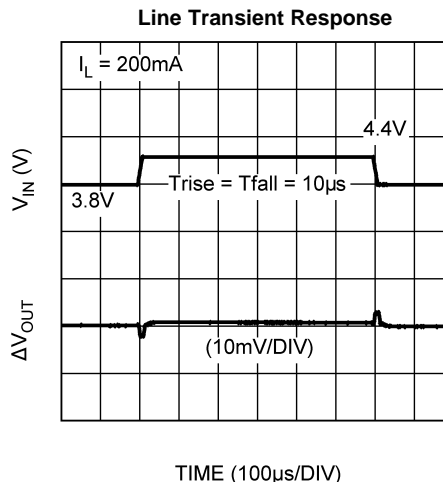

Figure 11.

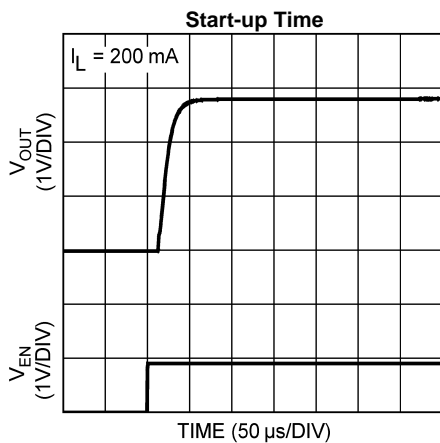

Figure 12.

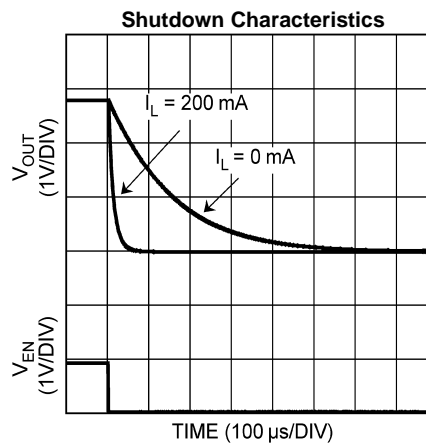

Figure 13.

TYPICAL PERFORMANCE CHARACTERISTICS (continued)

Unless otherwise specified, $C_{IN} = C_{OUT} = 1.0\mu F$, $V_{IN} = V_{OUT(NOM)} + 1.0V$, $V_{EN} = 1.0V$, $I_{OUT} = 1mA$, $T_A = 25^\circ C$.

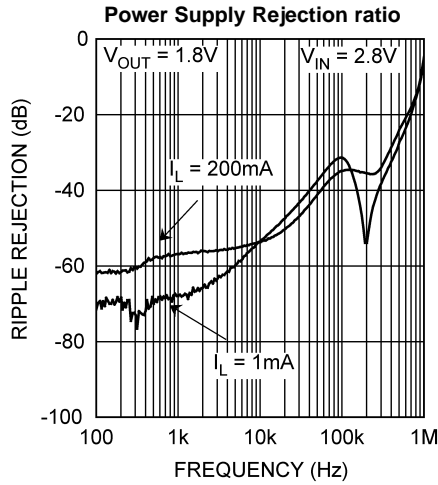

Figure 14.

Figure 15.

APPLICATION HINTS

POWER DISSIPATION AND DEVICE OPERATION

The permissible power dissipation for any package is a measure of the capability of the device to pass heat from the power source, the junctions of the IC, to the ultimate heat sink, the ambient environment. Thus the power dissipation is dependent on the ambient temperature and the thermal resistance across the various interfaces between the die and ambient air. As stated in Note 3 of the [Operating Ratings](#) table, the allowable power dissipation for the device in a given package can be calculated using the equation:

$$P_D = \frac{(T_{JMAX} - T_A)}{\theta_{JA}}$$

The actual power dissipation across the device can be represented by the following equation:

$$P_D = (V_{IN} - V_{OUT}) \times I_{OUT}$$

This establishes the relationship between the power dissipation allowed due to thermal consideration, the voltage drop across the device, and the continuous current capability of the device. These two equations should be used to determine the optimum operating conditions for the device in the application.

EXTERNAL CAPACITORS

Like any low-dropout regulator, the LP5990 requires external capacitors for regulator stability. The LP5990 is specifically designed for portable applications requiring minimum board space and smallest components. These capacitors must be correctly selected for good performance.

INPUT CAPACITOR

An input capacitor is required for stability. The input capacitor should be at least equal to or greater than the output capacitor. It is recommended that a 1.0 μ F capacitor be connected between the LP5990 input pin and ground.

This capacitor must be located a distance of not more than 1 cm from the input pin and returned to a clean analogue ground. Any good quality ceramic, tantalum, or film capacitor may be used at the input.

Important: To ensure stable operation it is essential that good PCB practices are employed to minimize ground impedance and keep input inductance low. If these conditions cannot be met, or if long leads are to be used to connect the battery or other power source to the LP5990, then it is recommended to increase the input capacitor to at least 2.2 μ F. Also, tantalum capacitors can suffer catastrophic failures due to surge current when connected to a low-impedance source of power (like a battery or a very large capacitor). If a tantalum capacitor is used at the input, it must be ensured by the manufacturer to have a surge current rating sufficient for the application. There are no requirements for the ESR (Equivalent Series Resistance) on the input capacitor, but tolerance and temperature coefficient must be considered when selecting the capacitor to ensure the capacitance will remain 0.3 μ F over the entire operating temperature range.

OUTPUT CAPACITOR

The LP5990 is designed specifically to work with very small ceramic output capacitors. A ceramic capacitor (dielectric types X5R or X7R) 1.0 μ F, and with ESR between 5 m Ω to 500 m Ω , is suitable in the LP5990 application circuit.

Other ceramic capacitors such as Y5V and Z5U are less suitable owing to their inferior temperature characteristics. (See section in [Capacitor Characteristics](#)).

For this device the output capacitor should be connected between the V_{OUT} pin and a good ground connection and should be mounted within 1 cm of the device.

It may also be possible to use tantalum or film capacitors at the device output, V_{OUT} , but these are not as attractive for reasons of size and cost (see the section [Capacitor Characteristics](#)).

The output capacitor must meet the requirement for the minimum value of capacitance (0.3 μ F) and have an ESR value that is within the range 5 m Ω to 500 m Ω for stability.

CAPACITOR CHARACTERISTICS

The LP5990 is designed to work with ceramic capacitors on the input and output to take advantage of the benefits they offer. For capacitance values in the range of 1.0 μF to 4.7 μF , ceramic capacitors are the smallest, least expensive and have the lowest ESR values, thus making them best for eliminating high frequency noise. The ESR of a typical 1.0 μF ceramic capacitor is in the range of 20 m Ω to 40 m Ω , which easily meets the ESR requirement for stability for the LP5990

For both input and output capacitors careful interpretation of the capacitor specification is required to ensure correct device operation. The capacitor value can change greatly depending on the conditions of operation and capacitor type.

In particular the output capacitor selection should take account of all the capacitor parameters to ensure that the specification is met within the application. Capacitance value can vary with DC bias conditions as well as temperature and frequency of operation. Capacitor values will also show some decrease over time due to aging. The capacitor parameters are also dependant on particular case size with smaller sizes giving poorer performance figures in general. As an example [Figure 16](#) shows a typical graph showing a comparison of capacitor case sizes in a Capacitance versus DC Bias plot. As shown in the graph, as a result of the DC Bias condition, the capacitance value may drop below the minimum capacitance value given in the recommended capacitor table (0.3 μF in this case). Note that the graph shows the capacitance out of spec for the 0402 case size capacitor at higher bias voltages. It is therefore recommend that the capacitor manufacturer's specifications for the nominal value capacitor are consulted for all conditions as some capacitors may not be suited in the application.

The temperature performance of ceramic capacitors varies by type and manufacturer. Most large value ceramic capacitors ($\geq 2.2 \mu\text{F}$) are manufactured with Z5U or Y5V temperature characteristics, which results in the capacitance dropping by more than 50% as the temperature goes from 25°C to 85°C.

A better choice for temperature coefficient in a ceramic capacitor is X7R. This type of capacitor is the most stable and holds the capacitance within $\pm 15\%$ over the temperature range. Tantalum capacitors are less desirable than ceramic for use as output capacitors because they are more expensive when comparing equivalent capacitance and voltage ratings in the 0.47 μF to 4.7 μF range.

Another important consideration is that tantalum capacitors have higher ESR values than equivalent size ceramics. This means that while it may be possible to find a tantalum capacitor with an ESR value within the stable range, it would have to be larger in capacitance (which means bigger and more costly) than a ceramic capacitor with the same ESR value. It should also be noted that the ESR of a typical tantalum will increase about 2:1 as the temperature goes from 25°C down to -40°C, so some guard band must be allowed.

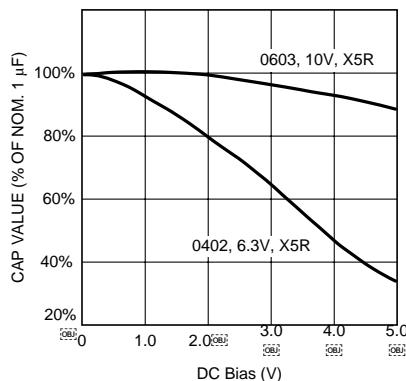

Figure 16.

NO-LOAD STABILITY

The LP5990 will remain stable and in regulation with no external load.

ENABLE CONTROL

The LP5990 may be switched ON or OFF by a logic input at the ENABLE pin, V_{EN} . A high voltage at this pin will turn the device on. When the enable pin is low, the regulator output is off and the device typically consumes 3 nA. If the application does not require the shutdown feature, the V_{EN} pin should be tied to V_{IN} to keep the regulator output permanently on.

The signal source used to drive the V_{EN} input must be able to swing above and below the specified turn-on/off voltage thresholds listed in the [Electrical Characteristics](#) section under V_{IL} and V_{IH} .

DSBGA MOUNTING

The DSBGA package requires specific mounting techniques, which are detailed in TI Application Note AN-1112 ([SNVA009](#)).

For best results during assembly, alignment ordinals on the PC board may be used to facilitate placement of the DSBGA device.

DSBGA LIGHT SENSITIVITY

Exposing the DSBGA device to direct light may cause incorrect operation of the device. Light sources such as halogen lamps can affect electrical performance if they are situated in proximity to the device.

Light with wavelengths in the red and infra-red part of the spectrum have the most detrimental effect thus the fluorescent lighting used inside most buildings has very little effect on performance.

PACKAGING INFORMATION

Orderable Device	Status (1)	Package Type	Package Drawing	Pins	Package Qty	Eco Plan (2)	Lead finish/ Ball material (6)	MSL Peak Temp (3)	Op Temp (°C)	Device Marking (4/5)	Samples
LP5990TM-1.2/NOPB	ACTIVE	DSBGA	YFQ	4	250	RoHS & Green	SNAGCU	Level-1-260C-UNLIM	-40 to 125		Samples
LP5990TM-1.8/NOPB	ACTIVE	DSBGA	YFQ	4	250	RoHS & Green	SNAGCU	Level-1-260C-UNLIM	-40 to 125		Samples
LP5990TM-2.8/NOPB	ACTIVE	DSBGA	YFQ	4	250	RoHS & Green	SNAGCU	Level-1-260C-UNLIM	-40 to 125		Samples
LP5990TM-3.0/NOPB	ACTIVE	DSBGA	YFQ	4	250	RoHS & Green	SNAGCU	Level-1-260C-UNLIM	-40 to 125		Samples
LP5990TM-3.6/NOPB	ACTIVE	DSBGA	YFQ	4	250	RoHS & Green	SNAGCU	Level-1-260C-UNLIM	-40 to 125		Samples
LP5990TMX-1.2/NOPB	ACTIVE	DSBGA	YFQ	4	3000	RoHS & Green	SNAGCU	Level-1-260C-UNLIM	-40 to 125		Samples
LP5990TMX-1.8/NOPB	ACTIVE	DSBGA	YFQ	4	3000	RoHS & Green	SNAGCU	Level-1-260C-UNLIM	-40 to 125		Samples
LP5990TMX-2.8/NOPB	ACTIVE	DSBGA	YFQ	4	3000	RoHS & Green	SNAGCU	Level-1-260C-UNLIM	-40 to 125		Samples
LP5990TMX-3.3/NOPB	ACTIVE	DSBGA	YFQ	4	3000	RoHS & Green	SNAGCU	Level-1-260C-UNLIM	-40 to 125		Samples
LP5990TMX-3.6/NOPB	ACTIVE	DSBGA	YFQ	4	3000	RoHS & Green	SNAGCU	Level-1-260C-UNLIM	-40 to 125		Samples

(1) The marketing status values are defined as follows:

ACTIVE: Product device recommended for new designs.

LIFEBUY: TI has announced that the device will be discontinued, and a lifetime-buy period is in effect.

NRND: Not recommended for new designs. Device is in production to support existing customers, but TI does not recommend using this part in a new design.

PREVIEW: Device has been announced but is not in production. Samples may or may not be available.

OBSELETE: TI has discontinued the production of the device.

(2) **RoHS:** TI defines "RoHS" to mean semiconductor products that are compliant with the current EU RoHS requirements for all 10 RoHS substances, including the requirement that RoHS substance do not exceed 0.1% by weight in homogeneous materials. Where designed to be soldered at high temperatures, "RoHS" products are suitable for use in specified lead-free processes. TI may reference these types of products as "Pb-Free".

RoHS Exempt: TI defines "RoHS Exempt" to mean products that contain lead but are compliant with EU RoHS pursuant to a specific EU RoHS exemption.

Green: TI defines "Green" to mean the content of Chlorine (Cl) and Bromine (Br) based flame retardants meet JS709B low halogen requirements of <=1000ppm threshold. Antimony trioxide based flame retardants must also meet the <=1000ppm threshold requirement.

(3) MSL, Peak Temp. - The Moisture Sensitivity Level rating according to the JEDEC industry standard classifications, and peak solder temperature.

(4) There may be additional marking, which relates to the logo, the lot trace code information, or the environmental category on the device.

⁽⁵⁾ Multiple Device Markings will be inside parentheses. Only one Device Marking contained in parentheses and separated by a "~" will appear on a device. If a line is indented then it is a continuation of the previous line and the two combined represent the entire Device Marking for that device.

⁽⁶⁾ Lead finish/Ball material - Orderable Devices may have multiple material finish options. Finish options are separated by a vertical ruled line. Lead finish/Ball material values may wrap to two lines if the finish value exceeds the maximum column width.

Important Information and Disclaimer:The information provided on this page represents TI's knowledge and belief as of the date that it is provided. TI bases its knowledge and belief on information provided by third parties, and makes no representation or warranty as to the accuracy of such information. Efforts are underway to better integrate information from third parties. TI has taken and continues to take reasonable steps to provide representative and accurate information but may not have conducted destructive testing or chemical analysis on incoming materials and chemicals. TI and TI suppliers consider certain information to be proprietary, and thus CAS numbers and other limited information may not be available for release.

In no event shall TI's liability arising out of such information exceed the total purchase price of the TI part(s) at issue in this document sold by TI to Customer on an annual basis.

TAPE AND REEL INFORMATION

QUADRANT ASSIGNMENTS FOR PIN 1 ORIENTATION IN TAPE

*All dimensions are nominal

Device	Package Type	Package Drawing	Pins	SPQ	Reel Diameter (mm)	Reel Width W1 (mm)	A0 (mm)	B0 (mm)	K0 (mm)	P1 (mm)	W (mm)	Pin1 Quadrant
LP5990TM-1.2/NOPB	DSBGA	YFQ	4	250	178.0	8.4	0.92	0.99	0.7	4.0	8.0	Q1
LP5990TM-1.8/NOPB	DSBGA	YFQ	4	250	178.0	8.4	0.92	0.99	0.7	4.0	8.0	Q1
LP5990TM-2.8/NOPB	DSBGA	YFQ	4	250	178.0	8.4	0.92	0.99	0.7	4.0	8.0	Q1
LP5990TM-3.0/NOPB	DSBGA	YFQ	4	250	178.0	8.4	0.92	0.99	0.7	4.0	8.0	Q1
LP5990TM-3.6/NOPB	DSBGA	YFQ	4	250	178.0	8.4	0.92	0.99	0.7	4.0	8.0	Q1
LP5990TMX-1.2/NOPB	DSBGA	YFQ	4	3000	178.0	8.4	0.92	0.99	0.7	4.0	8.0	Q1
LP5990TMX-1.8/NOPB	DSBGA	YFQ	4	3000	178.0	8.4	0.92	0.99	0.7	4.0	8.0	Q1
LP5990TMX-2.8/NOPB	DSBGA	YFQ	4	3000	178.0	8.4	0.92	0.99	0.7	4.0	8.0	Q1
LP5990TMX-3.3/NOPB	DSBGA	YFQ	4	3000	178.0	8.4	0.92	0.99	0.7	4.0	8.0	Q1
LP5990TMX-3.6/NOPB	DSBGA	YFQ	4	3000	178.0	8.4	0.92	0.99	0.7	4.0	8.0	Q1

TAPE AND REEL BOX DIMENSIONS

*All dimensions are nominal

Device	Package Type	Package Drawing	Pins	SPQ	Length (mm)	Width (mm)	Height (mm)
LP5990TM-1.2/NOPB	DSBGA	YFQ	4	250	208.0	191.0	35.0
LP5990TM-1.8/NOPB	DSBGA	YFQ	4	250	208.0	191.0	35.0
LP5990TM-2.8/NOPB	DSBGA	YFQ	4	250	208.0	191.0	35.0
LP5990TM-3.0/NOPB	DSBGA	YFQ	4	250	208.0	191.0	35.0
LP5990TM-3.6/NOPB	DSBGA	YFQ	4	250	208.0	191.0	35.0
LP5990TMX-1.2/NOPB	DSBGA	YFQ	4	3000	208.0	191.0	35.0
LP5990TMX-1.8/NOPB	DSBGA	YFQ	4	3000	208.0	191.0	35.0
LP5990TMX-2.8/NOPB	DSBGA	YFQ	4	3000	208.0	191.0	35.0
LP5990TMX-3.3/NOPB	DSBGA	YFQ	4	3000	208.0	191.0	35.0
LP5990TMX-3.6/NOPB	DSBGA	YFQ	4	3000	208.0	191.0	35.0

YFQ0004

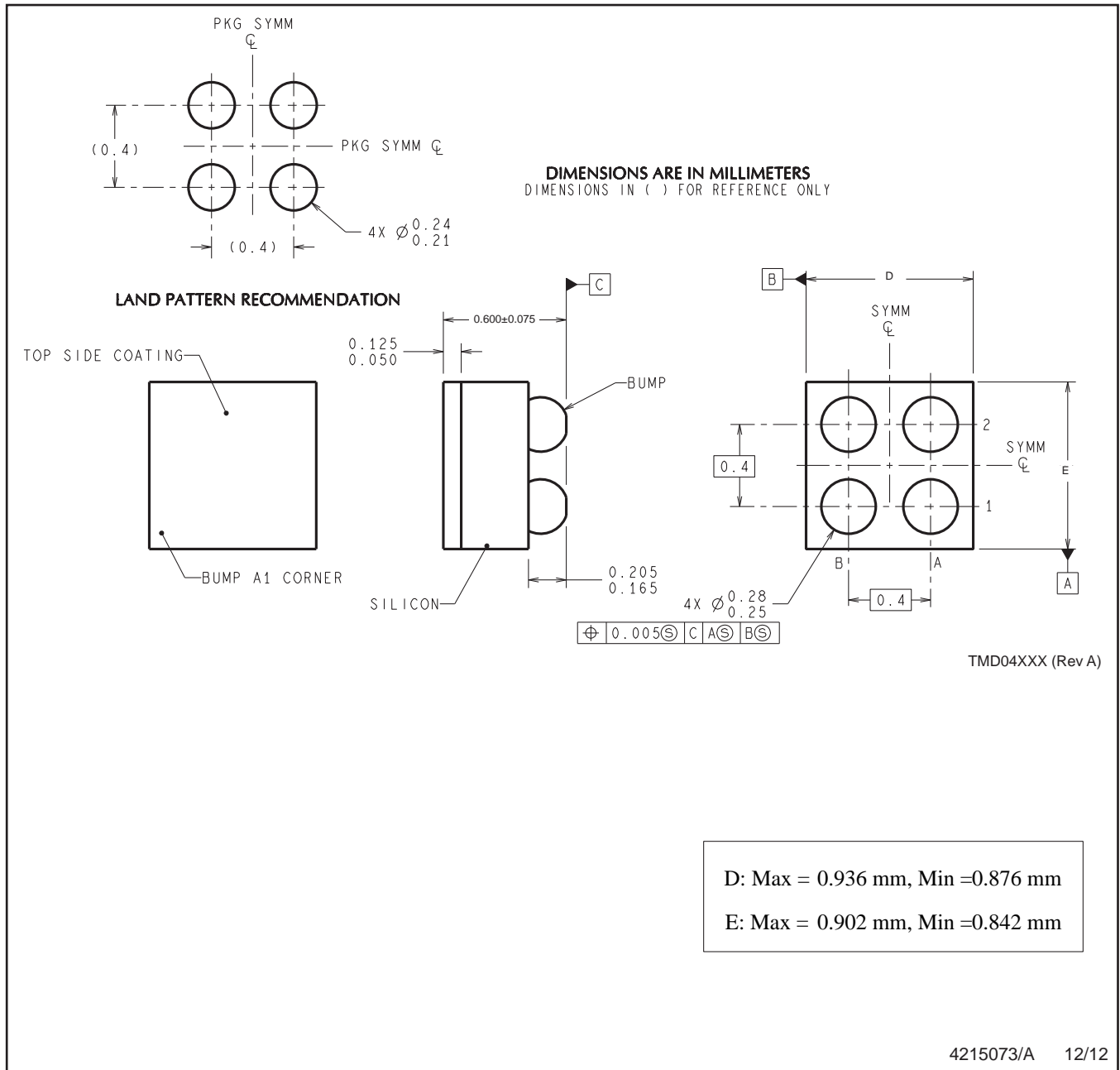

NOTES: A. All linear dimensions are in millimeters. Dimensioning and tolerancing per ASME Y14.5M-1994.
 B. This drawing is subject to change without notice.

IMPORTANT NOTICE AND DISCLAIMER

TI PROVIDES TECHNICAL AND RELIABILITY DATA (INCLUDING DATA SHEETS), DESIGN RESOURCES (INCLUDING REFERENCE DESIGNS), APPLICATION OR OTHER DESIGN ADVICE, WEB TOOLS, SAFETY INFORMATION, AND OTHER RESOURCES "AS IS" AND WITH ALL FAULTS, AND DISCLAIMS ALL WARRANTIES, EXPRESS AND IMPLIED, INCLUDING WITHOUT LIMITATION ANY IMPLIED WARRANTIES OF MERCHANTABILITY, FITNESS FOR A PARTICULAR PURPOSE OR NON-INFRINGEMENT OF THIRD PARTY INTELLECTUAL PROPERTY RIGHTS.

These resources are intended for skilled developers designing with TI products. You are solely responsible for (1) selecting the appropriate TI products for your application, (2) designing, validating and testing your application, and (3) ensuring your application meets applicable standards, and any other safety, security, regulatory or other requirements.

These resources are subject to change without notice. TI grants you permission to use these resources only for development of an application that uses the TI products described in the resource. Other reproduction and display of these resources is prohibited. No license is granted to any other TI intellectual property right or to any third party intellectual property right. TI disclaims responsibility for, and you will fully indemnify TI and its representatives against, any claims, damages, costs, losses, and liabilities arising out of your use of these resources.

TI's products are provided subject to [TI's Terms of Sale](#) or other applicable terms available either on ti.com or provided in conjunction with such TI products. TI's provision of these resources does not expand or otherwise alter TI's applicable warranties or warranty disclaimers for TI products.

TI objects to and rejects any additional or different terms you may have proposed.

Mailing Address: Texas Instruments, Post Office Box 655303, Dallas, Texas 75265
Copyright © 2022, Texas Instruments Incorporated