



## 9-W STEREO CLASS-D AUDIO POWER AMPLIFIER WITH DC VOLUME CONTROL

### FEATURES

- 9-W/Ch Into an 8-Ω Load From 12-V Supply
- Efficient, Class-D Operation Eliminates Heatsinks and Reduces Power Supply Requirements
- 32-Step DC Volume Control From -40 dB to 36 dB
- Line Outputs For External Headphone Amplifier With Volume Control
- Regulated 5-V Supply Output for Powering TPA6110A2
- Space-Saving, Thermally-Enhanced PowerPAD™ Packaging
- Thermal and Short-Circuit Protection

### DESCRIPTION

The TPA3002D2 is a 9-W (per channel) efficient, Class-D audio amplifier for driving bridged-tied stereo speakers. The TPA3002D2 can drive stereo speakers as low as 8 Ω. The high efficiency of the TPA3002D2 eliminates the need for external heatsinks when playing music.

Stereo speaker volume is controlled with a dc voltage applied to the volume control terminal offering a range of gain from -40 dB to 36 dB. Line outputs, for driving external headphone amplifier inputs, are also dc voltage controlled with a range of gain from -56 dB to 20 dB.

An integrated 5-V regulated supply is provided for powering an external headphone amplifier.

### APPLICATIONS

- LCD Monitors and TVs
- Powered Speakers

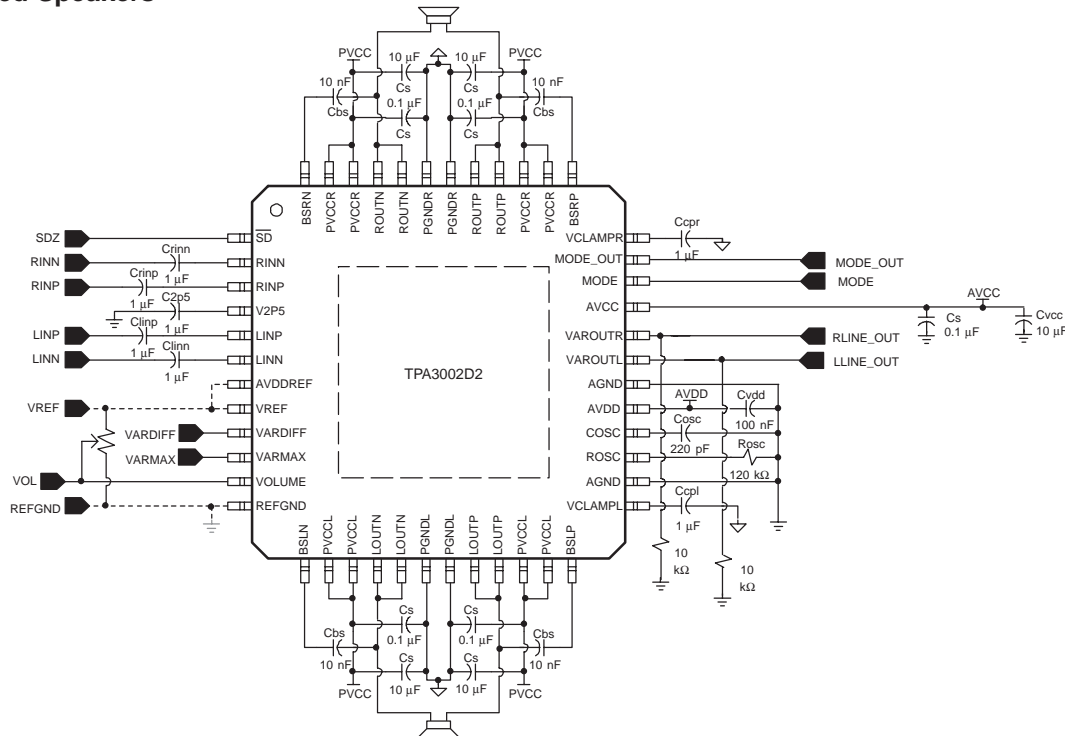

Please be aware that an important notice concerning availability, standard warranty, and use in critical applications of Texas Instruments semiconductor products and disclaimers thereto appears at the end of this data sheet.

PowerPAD is a trademark of Texas Instruments.

# TPA3002D2

SLOS402C – DECEMBER 2002 – REVISED JANUARY 2004



These devices have limited built-in ESD protection. The leads should be shorted together or the device placed in conductive foam during storage or handling to prevent electrostatic damage to the MOS gates.

## AVAILABLE OPTIONS

T <sub>A</sub>	PACKAGED DEVICE
-40°C to 85°C	TPA3002D2PHP

(1) The PHP package is available taped and reeled. To order a taped and reeled part, add the suffix R to the part number (e.g., TPA3002D2PHPR).

## PIN ASSIGNMENTS

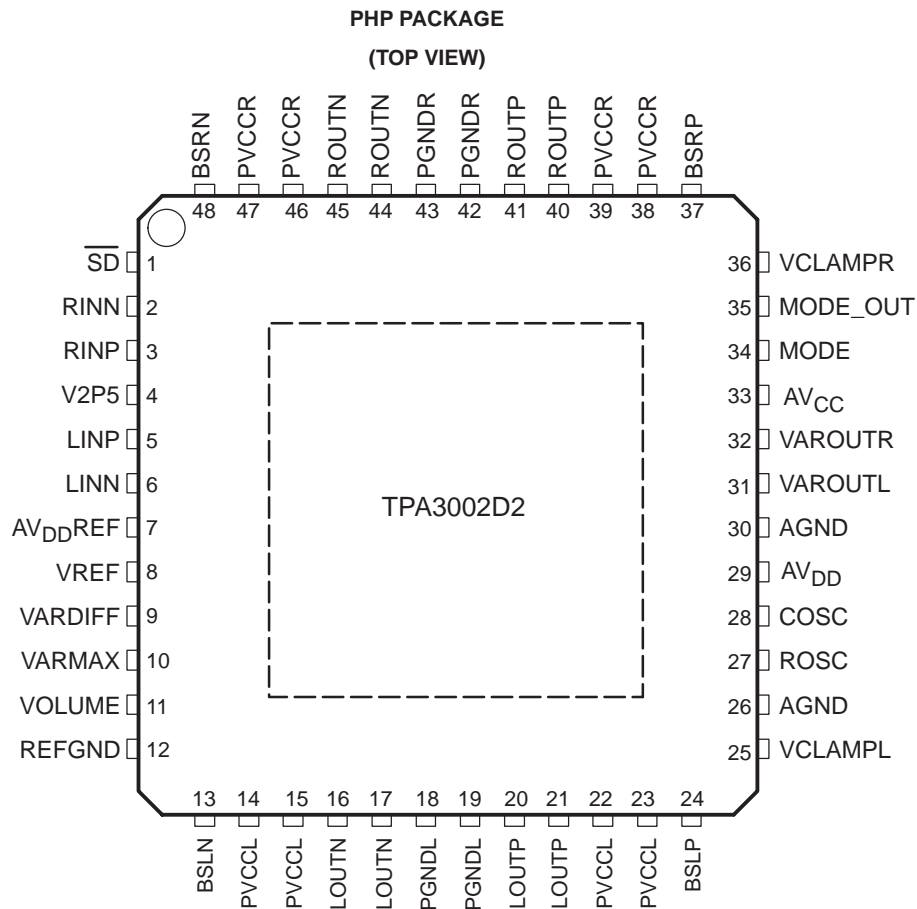

**FUNCTIONAL BLOCK DIAGRAM**

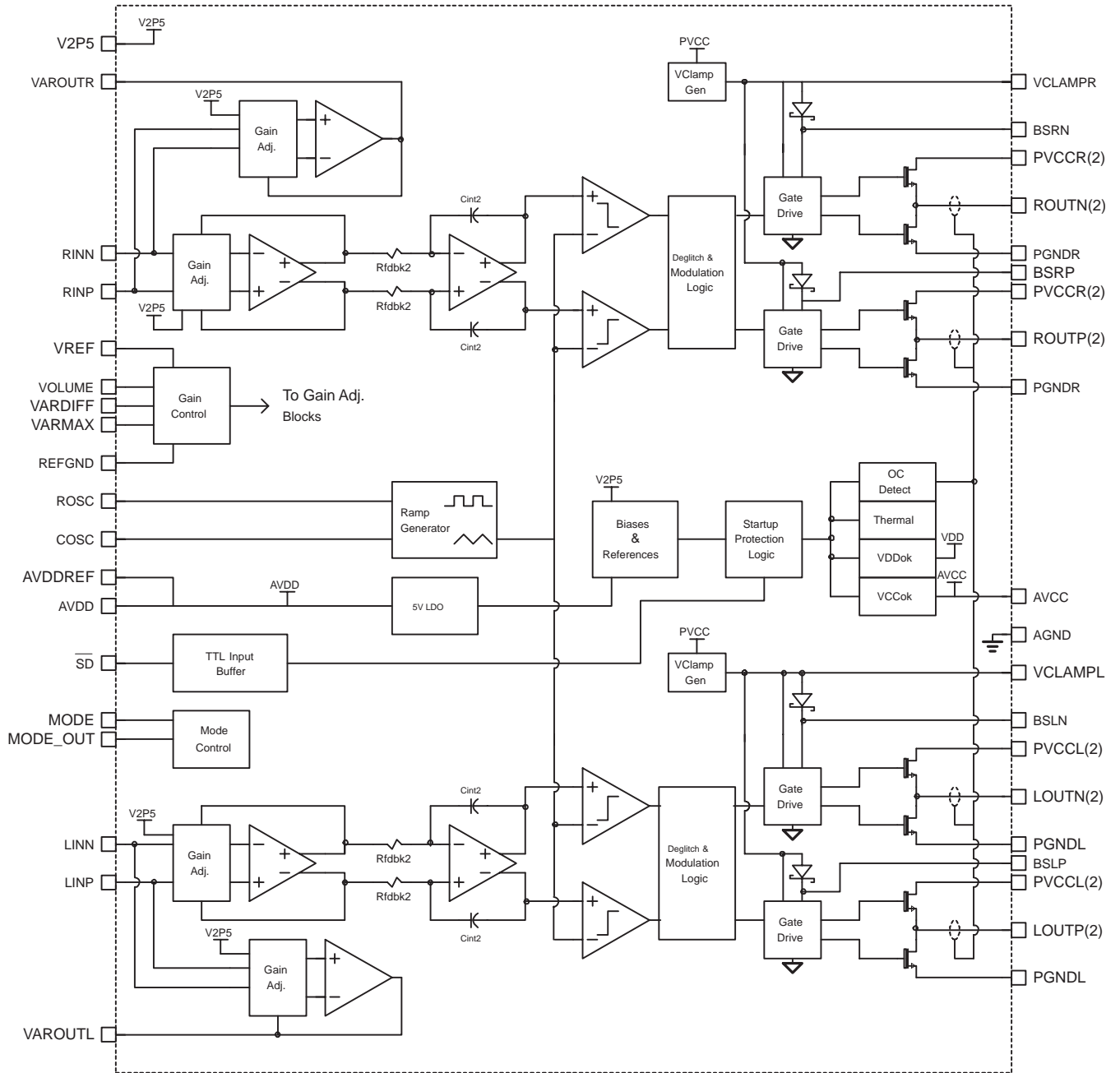

**Terminal Functions**

TERMINAL NO.	NAME	I/O	DESCRIPTION
AGND	26, 30	–	Analog ground for digital/analog cells in core
AVCC	33	–	High-voltage analog power supply (8.5 V to 14 V)
AVDD	29	O	5-V Regulated output capable of 100-mA output
AVDDREF	7	O	5-V Reference output—provided for connection to adjacent VREF terminal.
BSLN	13	I/O	Bootstrap I/O for left channel, negative high-side FET
BSLP	24	I/O	Bootstrap I/O for left channel, positive high-side FET
BSRN	48	I/O	Bootstrap I/O for right channel, negative high-side FET
BSRP	37	I/O	Bootstrap I/O for right channel, positive high-side FET
COSC	28	I/O	I/O for charge/discharging currents onto capacitor for ramp generator triangle wave biased at V2P5
LINN	6	I	Negative differential audio input for left channel
LINP	5	I	Positive differential audio input for left channel
LOUTN	16, 17	O	Class-D 1/2-H-bridge negative output for left channel
LOUTP	20, 21	O	Class-D 1/2-H-bridge positive output for left channel
MODE	34	I	Input for MODE control. A logic high on this pin places the amplifier in the variable output mode and the Class-D outputs are disabled. A logic low on this pin places the amplifier in the Class-D mode and Class-D stereo outputs are enabled. Variable outputs (VAROUTL and VAROUTR) are still enabled in Class-D mode to be used as line-level outputs for external amplifiers.
MODE_OUT	35	O	Output for control of the variable output amplifiers. When the MODE pin (34) is a logic high, the MODE_OUT pin is driven low. When the MODE pin (34) is a logic low, the MODE_OUT pin is driven high. This pin is intended for MUTE control of an external headphone amplifier. Leave unconnected when not used for headphone amplifier control.
PGNDL	18, 19	–	Power ground for left channel H-bridge
PGNDR	42, 43	–	Power ground for right channel H-bridge
PVCCL	14, 15	–	Power supply for left channel H-bridge (tied to pins 22 and 23 internally), not connected to PVCCR or AVCC.
PVCCL	22, 23	–	Power supply for left channel H-bridge (tied to pins 14 and 15 internally), not connected to PVCCR or AVCC.
PVCCR	38,39	–	Power supply for right channel H-bridge (tied to pins 46 and 47 internally), not connected to PVCCL or AVCC.
PVCCR	46, 47	–	Power supply for right channel H-bridge (tied to pins 38 and 39 internally), not connected to PVCCL or AVCC.
REFGND	12	–	Ground for gain control circuitry. Connect to AGND. If using a DAC to control the volume, connect the DAC ground to this terminal.
RINP	3	I	Positive differential audio input for right channel
RINN	2	I	Negative differential audio input for right channel
ROSC	27	I/O	Current setting resistor for ramp generator. Nominally equal to $1/8 \cdot V_{CC}$
ROUTN	44, 45	O	Class-D 1/2-H-bridge negative output for right channel
ROUTP	40, 41	O	Class-D 1/2-H-bridge positive output for right channel
SD	1	I	Shutdown signal for IC (low = shutdown, high = operational). TTL logic levels with compliance to $V_{CC}$ .
VARDIFF	9	I	DC voltage to set the difference in gain between the Class-D and VAROUT outputs. Connect to GND or AVDDREF if VAROUT outputs are unconnected.
VARMAX	10	I	DC voltage that sets the maximum gain for the VAROUT outputs. Connect to GND or AVDDREF if VAROUT outputs are unconnected.
VAROUTL	31	O	Variable output for left channel audio. Line level output for driving external HP amplifier.
VAROUTR	32	O	Variable output for right channel audio. Line level output for driving external HP amplifier.
VCLAMPL	25	–	Internally generated voltage supply for left channel bootstrap capacitors.
VCLAMPR	36	–	Internally generated voltage supply for right channel bootstrap capacitors.
VOLUME	11	I	DC voltage that sets the gain of the Class-D and VAROUT outputs.
VREF	8	I	Analog reference for gain control section.
V2P5	4	O	2.5-V Reference for analog cells, as well as reference for unused audio input when using single-ended inputs.
—	Thermal Pad	–	Connect to AGND and PGND—should be center point for both grounds.

**ABSOLUTE MAXIMUM RATINGS**

over operating free-air temperature range unless otherwise noted<sup>(1)</sup>

		UNIT
Supply voltage range:	AVCC, PVCC	-0.3 V to 15 V
Input voltage range, V <sub>I</sub>	MODE, VREF, VARDIFF, VARMAX, VOLUME	0 V to 5.5 V
	SD	-0.3 V to V <sub>CC</sub> + 0.3 V
	RINN, RINP, LINN, LINP	-0.3 V to 7 V
Supply current	AVDD	120 mA
	AVDDREF	10 mA
Output current,	VAROURL, VAROURL	20 mA
Continuous total power dissipation		See Dissipation Rating Table
Operating free-air temperature range, T <sub>A</sub>		-40°C to 85°C
Operating junction temperature range, T		-40°C to 150°C
Storage temperature range, T <sub>stg</sub>		-65°C to 150°C
Lead temperature 1,6 mm (1/16 inch) from case for 10 seconds		260°C

(1) Stresses beyond those listed under "absolute maximum ratings" may cause permanent damage to the device. These are stress ratings only, and functional operation of the device at these or any other conditions beyond those indicated under "recommended operating conditions" is not implied. Exposure to absolute-maximum-rated conditions for extended periods may affect device reliability.

**PACKAGE DISSIPATION RATINGS**

PACKAGE	T <sub>A</sub> ≤ 25°C	DERATING FACTOR	T <sub>A</sub> = 70°C	T <sub>A</sub> = 85°C
PHP	4.3 W	34.7 mW/°C <sup>(1)</sup>	2.7 W	2.2 W

(1) The PowerPAD must be soldered to a thermal land on the printed circuit board. Please refer to the *PowerPAD Thermally Enhanced Package* application note (SLMA002).

**RECOMMENDED OPERATING CONDITIONS**

		MIN	MAX	UNIT
Supply voltage, V <sub>CC</sub>	PVCC, AVCC	8.5	14	V
Volume reference voltage	VREF	3.0	5.5	V
Volume control pins, input voltage	VARDIFF, VARMAX, VOLUME		5.5	V
High-level input voltage, V <sub>IH</sub>	$\overline{\text{SD}}$	2		V
	MODE	3.5		
Low-level input voltage, V <sub>IL</sub>	$\overline{\text{SD}}$		0.8	V
	MODE		2	
High-level output voltage, V <sub>OH</sub>	MODE_OUT, I <sub>OH</sub> = 1 mA	AVDD-100mV		V
Low-level output voltage, V <sub>OL</sub>	MODE_OUT, I <sub>OL</sub> = -1 mA	AGND+100mV		V
High-level input current, I <sub>IH</sub>	MODE, V <sub>I</sub> = 5 V, V <sub>CC</sub> = 14 V		1	uA
	$\overline{\text{SD}}$ , V <sub>I</sub> = 14 V, V <sub>CC</sub> = 14 V		30	
Low-level input current, I <sub>IL</sub>	MODE, V <sub>I</sub> = 0 V, V <sub>CC</sub> = 14 V		1	uA
	$\overline{\text{SD}}$ , V <sub>I</sub> = 0 V, V <sub>CC</sub> = 14 V		1	
Oscillator frequency, f <sub>OSC</sub>		225	275	kHz
Operating free-air temperature, T <sub>A</sub>		-40	85	°C

# TPA3002D2

SLOS402C – DECEMBER 2002 – REVISED JANUARY 2004

## DC ELECTRICAL CHARACTERISTICS

 $T_A = 25^\circ\text{C}$ ,  $V_{CC} = 12\text{ V}$ ,  $R_L = 8\ \Omega$  (unless otherwise noted)

PARAMETER		TEST CONDITIONS	MIN	TYP	MAX	UNIT
$ V_{OS} $	Class-D Output offset voltage (measured differentially)	INN and INP connected together, Gain = 36 dB		10	65	mV
V2P5 (terminal 4)	2.5-V Bias voltage	No load	0.45x AVDD	0.5x AVDD	0.55x AVDD	V
AVDD	5-V Regulated output	$I_O = 0$ to 100 mA, $\overline{SD} = 2\text{ V}$ , $V_{CC} = 8\text{ V}$ to 14 V	4.5	5.0	5.5	V
PSRR	Class-D power supply rejection ratio	$V_{CC} = 11.5\text{ V}$ to 12.5 V		-80		dB
$I_{CC}(\text{class-D})$	Class-D mode quiescent current	MODE = 2 V, $\overline{SD} = 2\text{ V}$		16	28.5	mA
$I_{CC}(\text{varout})$	Variable output mode quiescent current	MODE = 3.5 V, $\overline{SD} = 2\text{ V}$		7	9	mA
$I_{CC}(\text{class-D} - \text{max power})$	Class-D mode RMS current at max power	$R_L = 8\ \Omega$ , $P_O = 9\text{ W}$		2		A
$I_{CC}(\text{SD})$	Supply current in shutdown mode	$\overline{SD} = 0.8\text{ V}$		1	10	uA
$r_{ds(on)}$	Drain-source on-state resistance	$V_{CC} = 12\text{ V}$ , $I_O = 1\text{ A}$ , $T_J = 25^\circ\text{C}$	High side	300		m $\Omega$
			Low side	250		
			Total	550	590	

## AC ELECTRICAL CHARACTERISTICS FOR CLASS-D OUTPUTS

 $T_A = 25^\circ\text{C}$ ,  $V_{CC} = 12\text{ V}$ ,  $R_L = 8\ \Omega$  (unless otherwise noted)

PARAMETER		TEST CONDITIONS	MIN	TYP	MAX	UNITS
$k_{SVR}$	Supply ripple rejection ratio	$V_{CC} = 11.5\text{ V}$ to 12.5 V from 10 Hz to 1 kHz, Gain = 36 dB		-67		dB
$P_O$	Continuous output power	THD+N = 1%, $f = 1\text{ kHz}$ , $R_L = 8\ \Omega$		7.5		W
		THD+N = 10%, $f = 1\text{ kHz}$ , $R_L = 8\ \Omega$		9		W
$V_n$	Output integrated noise floor	20 Hz to 22 kHz, No filter, Gain = 0.5 dB		79		$\mu\text{V}$
				-82		dBV
		20 Hz to 22 kHz, A-weighted filter, Gain = 13.2 dB		100		$\mu\text{V}$
				-80		dBV
	Crosstalk, Class-D–Left → Class-D–Right	Gain = 13.2 dB, $P_O = 1\text{ W}$ , $R_L = 8\ \Omega$		-77		dB
	Crosstalk, Class-D → VAROUT	Maximum output at THD < 0.5%, Gain = 36 dB		-63		dB
SNR	Signal-to-noise ratio	Maximum output at THD+N < 0.5%, $f = 1\text{ kHz}$ , Gain = 36 dB		96		dB
	Thermal trip point			150		$^\circ\text{C}$
	Thermal hysteresis			20		$^\circ\text{C}$

## CHARACTERISTICS FOR VAROUT OUTPUTS

PARAMETER		TEST CONDITIONS	MIN	TYP	MAX	UNITS
$ V_{OS} $	Output offset voltage	Measured between V2P5 and VAROUT, Gain = 20 dB, $R_L = 10\text{ k}\Omega$		10		mV
THD+N	Total harmonic distortion + noise	$A_V = 7.3\text{ dB}$ , $f = 1\text{ kHz}$ , $P_O = 6\text{ mW}$ , $R_L = 32\ \Omega$		0.025%		
		$A_V = 7.3\text{ dB}$ , $f = 1\text{ kHz}$ , $R_L = 2\text{ k}\Omega$ , $V_O = 1\text{ V}_{\text{rms}}$		0.002%		
PSRR	DC power supply rejection ratio	Gain = 20 dB		-74		dB
$k_{SVR}$	Supply ripple rejection ratio	Gain = 20 dB, $f = 1\text{ kHz}$		-95		dB
	Crosstalk, VAROUTL → VAROUTR	Maximum output at THD < 0.5%, Gain = 20 dB		-60		dB
	Crosstalk, VAROUT → Class-D	Maximum output at THD < 0.5%, Gain = 20 dB		-74		dB
$V_n$	Output integrated noise floor	20 Hz to 22 kHz, Gain = 20 dB		75		$\mu\text{V}$
		20 Hz to 22 kHz, Gain = -0.3 dB		15		

**Table 1. DC Volume Control for Class-D Outputs**

VOLTAGE ON THE VOLUME PIN AS A PERCENTAGE OF VREF (INCREASING VOLUME OR FIXED GAIN)	VOLTAGE ON THE VOLUME PIN AS A PERCENTAGE OF VREF (DECREASING VOLUME)	GAIN OF CLASS-D AMPLIFIER
%	%	dB
0 – 4.5	0 – 2.9	-75 <sup>(1)</sup>
4.5 – 6.7	2.9 – 5.1	-40.0
6.7 – 8.91	5.1 – 7.2	-37.5
8.9 – 11.1	7.2 – 9.4	-35.0
11.1 – 13.3	9.4 – 11.6	-32.4
13.3 – 15.5	11.6 – 13.8	-29.9
15.5 – 17.7	13.8 – 16.0	-27.4
17.7 – 19.9	16.0 – 18.2	-24.8
19.9 – 22.1	18.2 – 20.4	-22.3
22.1 – 24.3	20.4 – 22.6	-19.8
24.3 – 26.5	22.6 – 24.8	-17.2
26.5 – 28.7	24.8 – 27.0	-14.7
28.7 – 30.9	27.0 – 29.1	-12.2
30.9 – 33.1	29.1 – 31.3	-9.6
33.1 – 35.3	31.3 – 33.5	-7.1
35.3 – 37.5	33.5 – 35.7	-4.6
37.5 – 39.7	35.7 – 37.9	-2.0
39.7 – 41.9	37.9 – 40.1	0.5 <sup>†</sup>
41.9 – 44.1	40.1 – 42.3	3.1
44.1 – 46.4	42.3 – 44.5	5.6
46.4 – 48.6	44.5 – 46.7	8.1
48.6 – 50.8	46.7 – 48.9	10.7
50.8 – 53.0	48.9 – 51.0	13.2
53.0 – 55.2	51.0 – 53.2	15.7
55.2 – 57.4	53.2 – 55.4	18.3
57.4 – 59.6	55.4 – 57.6	20.8
59.6 – 61.8	57.6 – 59.8	23.3
61.8 – 64.0	59.8 – 62.0	25.9
64.0 – 66.2	62.0 – 64.2	28.4
66.2 – 68.4	64.2 – 66.4	30.9
68.4 – 70.6	66.4 – 68.6	33.5
> 70.6	>68.6	36.0 <sup>(1)</sup>

<sup>(1)</sup> Tested in production. Remaining steps are specified by design.

**Table 2. DC Volume Control for VAROUT Outputs**

VAROUT_VOLUME (V) – FROM FIGURE 35 – AS A PERCENTAGE OF VREF (INCREASING VOLUME OR FIXED GAIN)	VAROUT_VOLUME (V) – FROM FIGURE 35 – AS A PERCENTAGE OF VREF (DECREASING VOLUME)	GAIN OF VAROUT AMPLIFIER
%	%	dB
0 – 4.5	0 – 2.9	-66 <sup>(1)</sup>
4.5 – 6.7	2.9 – 5.1	-56.0
6.7 – 8.91	5.1 – 7.2	-53.5
8.9 – 11.1	7.2 – 9.4	-50.9
11.1 – 13.3	9.4 – 11.6	-48.4
13.3 – 15.5	11.6 – 13.8	-45.9
15.5 – 17.7	13.8 – 16.0	-43.3
17.7 – 19.9	16.0 – 18.2	-40.8
19.9 – 22.1	18.2 – 20.4	-38.3
22.1 – 24.3	20.4 – 22.6	-35.7
24.3 – 26.5	22.6 – 24.8	-33.2
26.5 – 28.7	24.8 – 27.0	-30.7
28.7 – 30.9	27.0 – 29.1	-28.1
30.9 – 33.1	29.1 – 31.3	-25.6
33.1 – 35.3	31.3 – 33.5	-23.1
35.3 – 37.5	33.5 – 35.7	-20.5
37.5 – 39.7	35.7 – 37.9	-18.0
39.7 – 41.9	37.9 – 40.1	-15.5
41.9 – 44.1	40.1 – 42.3	-13.0 <sup>(1)</sup>
44.1 – 46.4	42.3 – 44.5	-10.4
46.4 – 48.6	44.5 – 46.7	-7.9
48.6 – 50.8	46.7 – 48.9	-5.3
50.8 – 53.0	48.9 – 51.0	-2.8
53.0 – 55.2	51.0 – 53.2	-0.3
55.2 – 57.4	53.2 – 55.4	2.3
57.4 – 59.6	55.4 – 57.6	4.8
59.6 – 61.8	57.6 – 59.8	7.3
61.8 – 64.0	59.8 – 62.0	9.9
64.0 – 66.2	62.0 – 64.2	12.4
66.2 – 68.4	64.2 – 66.4	14.9
68.4 – 70.6	66.4 – 68.6	17.5
> 70.6	>68.6	20.0 <sup>(1)</sup>

<sup>(1)</sup> Tested in production. Remaining steps are specified by design.



**TYPICAL CHARACTERISTICS**

**TABLE OF GRAPHS**

			<b>FIGURE</b>
	Class-D Efficiency	vs Output power	1
P <sub>O</sub>	Class-D Output power	vs Load resistance	2
		vs Supply voltage	3
I <sub>CC</sub>	Class-D Supply current	vs Supply voltage	4
		vs Output Power	5
I <sub>O(sd)</sub>	Shutdown supply current	vs Supply voltage	6
	Class-D Input resistance	vs Gain	7
THD+N	Class-D Total harmonic distortion + noise	vs Frequency	8, 9
		vs Output power	10, 11
k <sub>SVR</sub>	Class-D Supply ripple rejection ratio	vs Frequency	12
	Class-D Closed loop response		13
	Class-D Intermodulation performance		14
	Class-D Input offset voltage	vs Common-mode input voltage	15
	Class-D Crosstalk	vs Frequency	16
	Class-D Mute attenuation	vs Frequency	17
	Class-D Shutdown attenuation		18
	Class-D Common-mode rejection ratio	vs Frequency	19
	VAROUT Input resistance	vs Gain	20
	VAROUT Noise	vs Frequency	21
	VAROUT Closed Loop Response		22
	VAROUT Common-mode rejection ratio	vs Frequency	23
	VAROUT Crosstalk	vs Frequency	24
THD+N	VAROUT Total harmonic distortion + noise	vs Output power	25
		vs Output voltage	26
		vs Frequency	27
k <sub>SVR</sub>	VAROUT Supply ripple rejection ratio	vs Frequency	28

TPA3002D2

SLOS402C – DECEMBER 2002 – REVISED JANUARY 2004

EFFICIENCY  
VS  
OUTPUT POWER

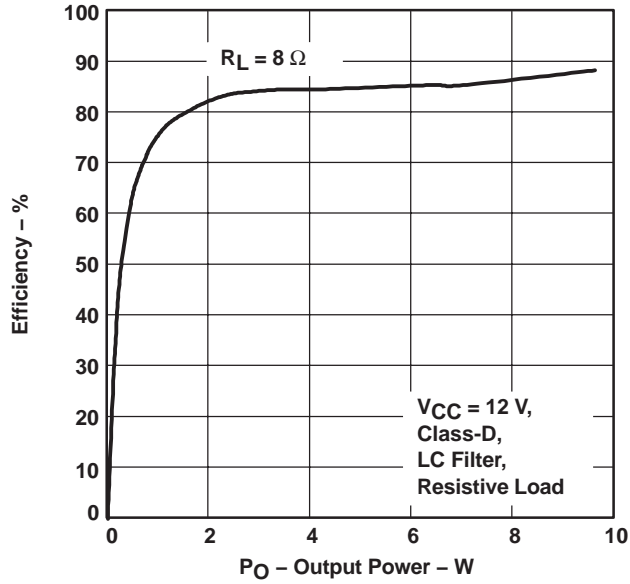

Figure 1

OUTPUT POWER  
VS  
LOAD RESISTANCE

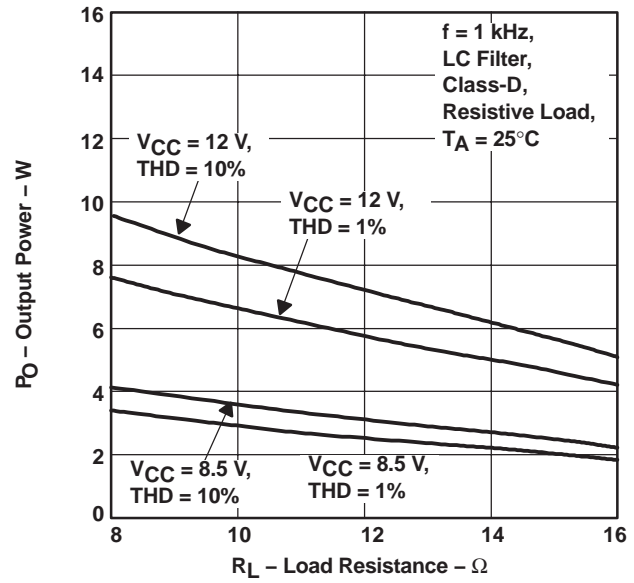

Figure 2

OUTPUT POWER  
VS  
SUPPLY VOLTAGE

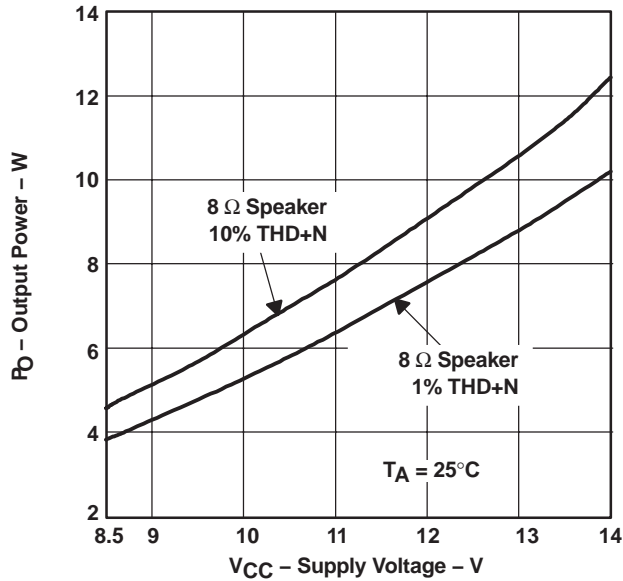

Figure 3

SUPPLY CURRENT  
VS  
SUPPLY VOLTAGE

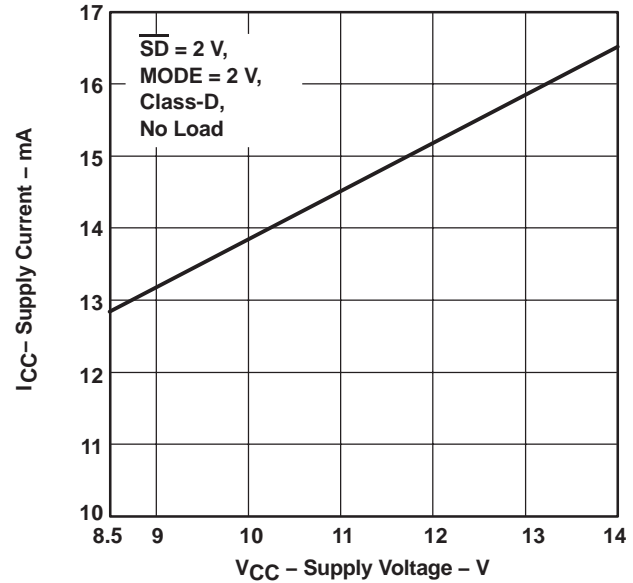

Figure 4

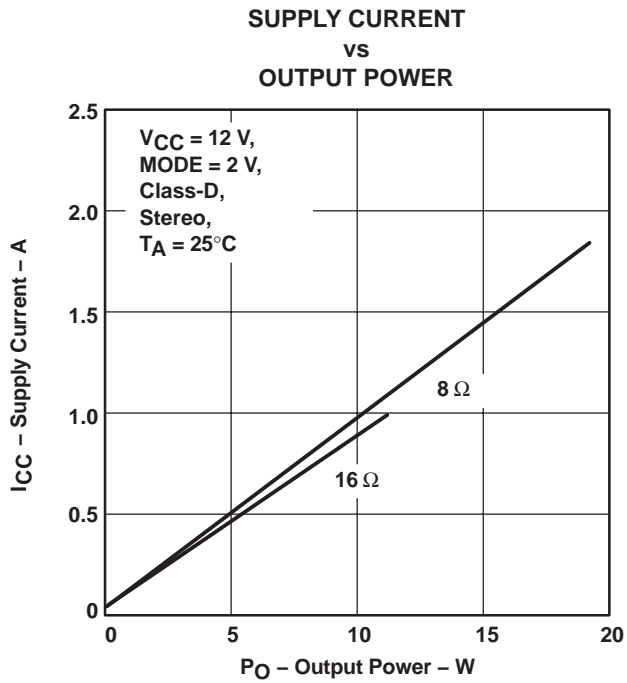

Figure 5

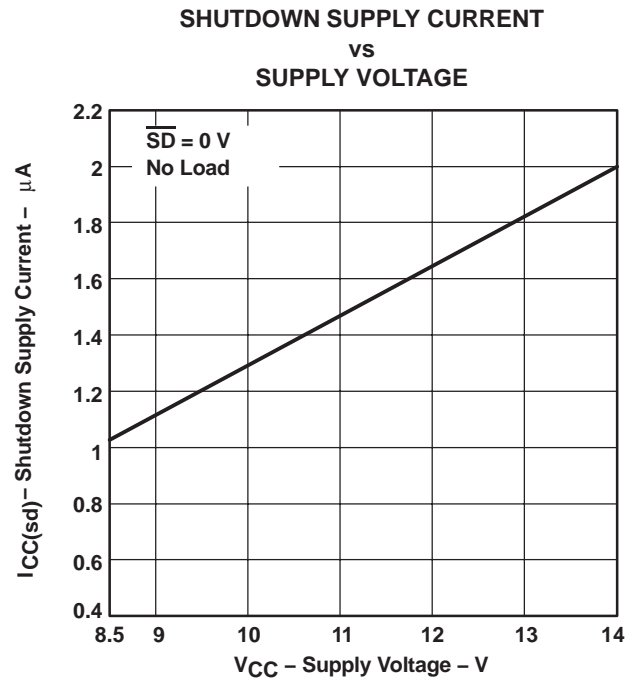

Figure 6

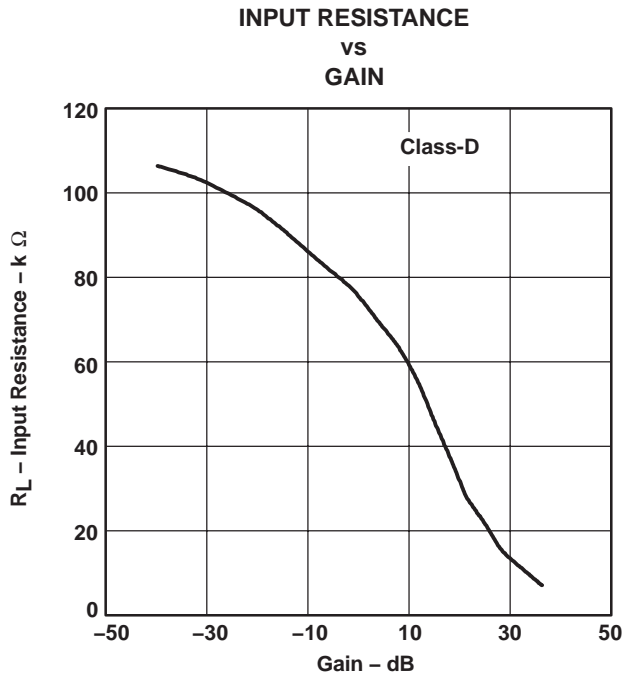

Figure 7

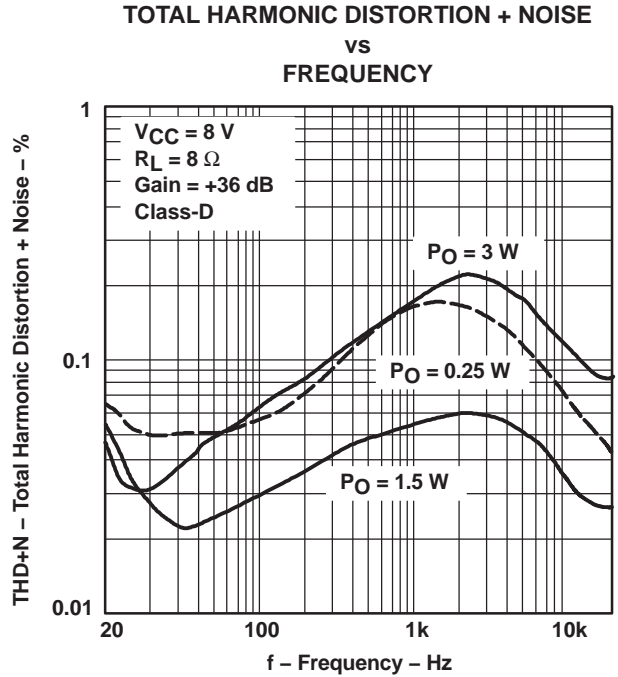

Figure 8

TOTAL HARMONIC DISTORTION + NOISE  
vs  
FREQUENCY

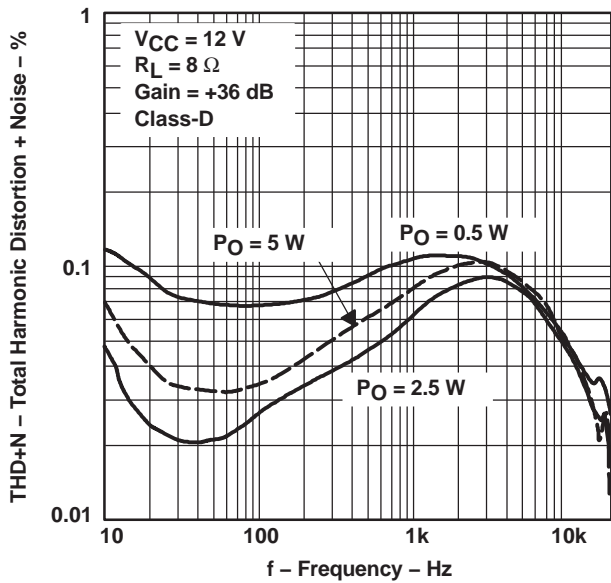

Figure 9

TOTAL HARMONIC DISTORTION + NOISE  
vs  
OUTPUT POWER

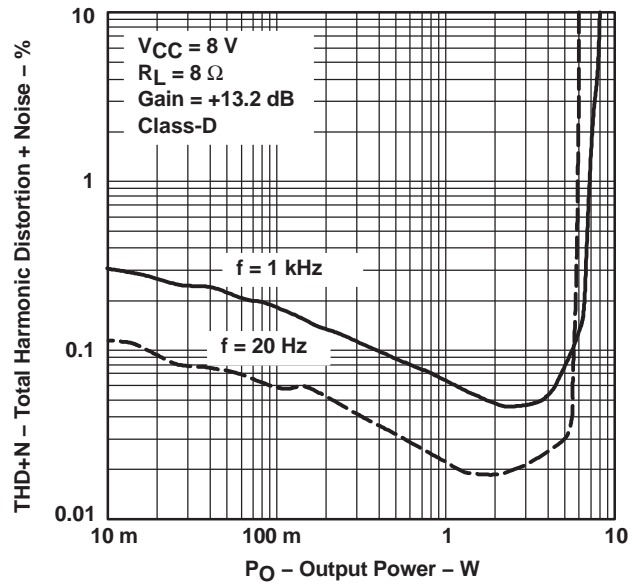

Figure 10

TOTAL HARMONIC DISTORTION + NOISE  
vs  
OUTPUT POWER

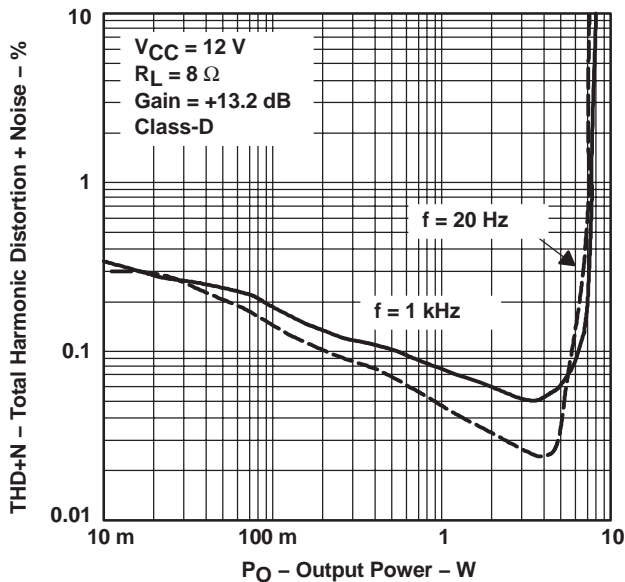

Figure 11

SUPPLY RIPPLE REJECTION RATIO  
vs  
FREQUENCY

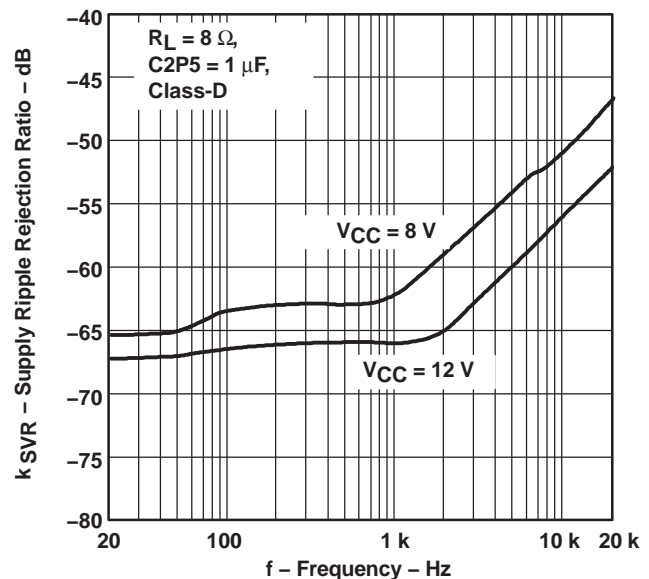

Figure 12

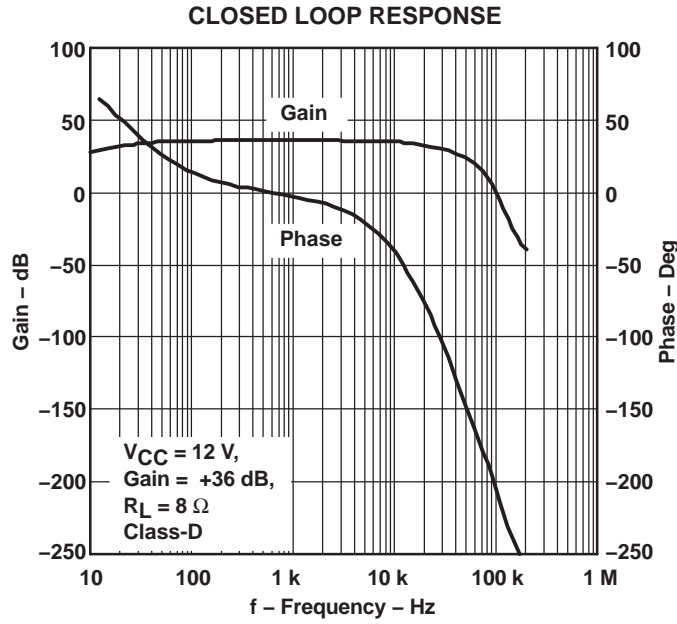

Figure 13

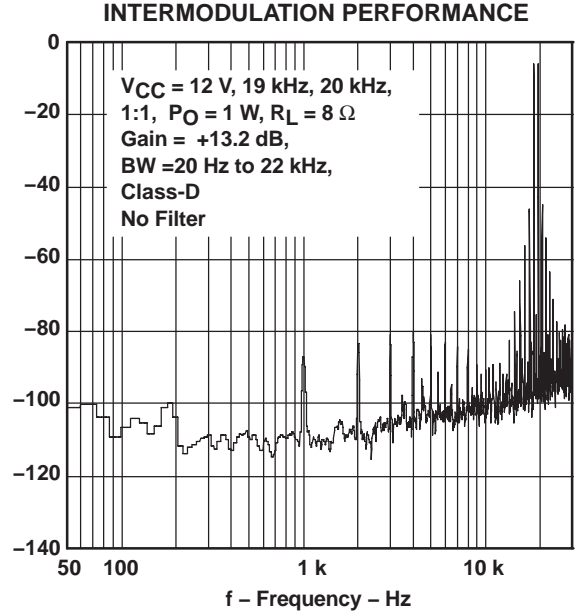

Figure 14

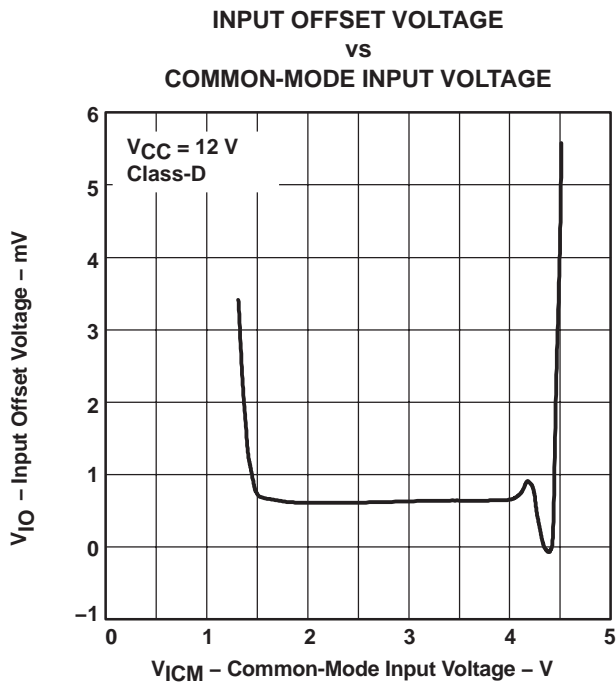

Figure 15

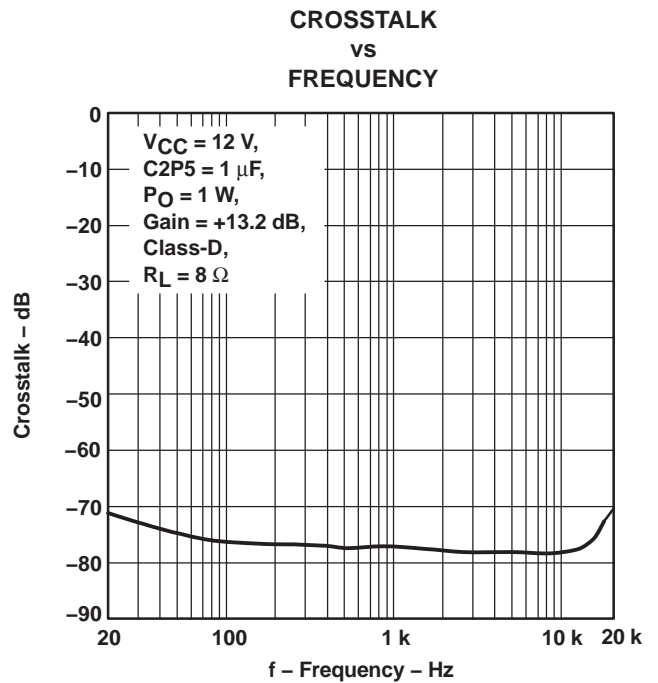

Figure 16

TPA3002D2

SLOS402C – DECEMBER 2002 – REVISED JANUARY 2004

MUTE ATTENUATION  
VS  
FREQUENCY

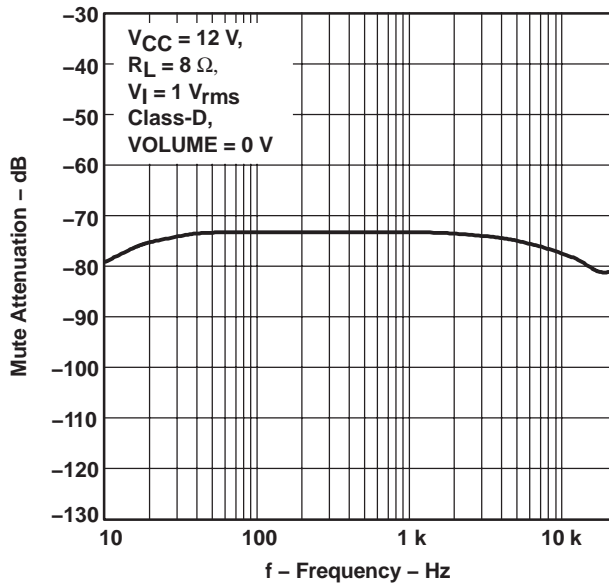

Figure 17

SHUTDOWN ATTENUATION  
VS  
FREQUENCY

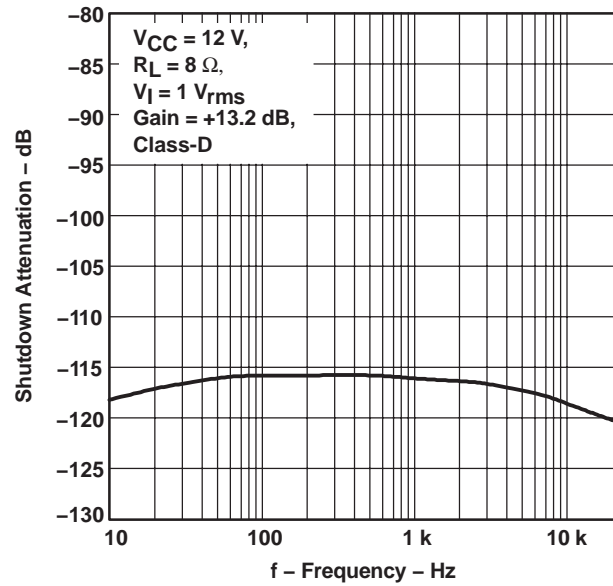

Figure 18

COMMON-MODE REJECTION RATIO  
VS  
FREQUENCY

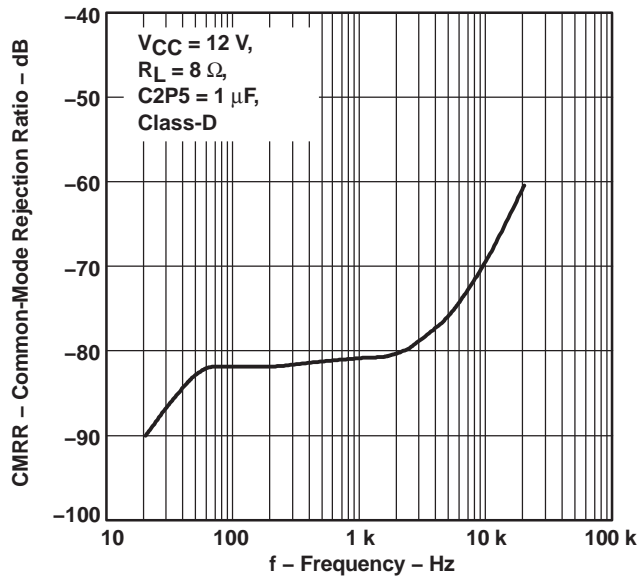

Figure 19

INPUT RESISTANCE  
VS  
GAIN

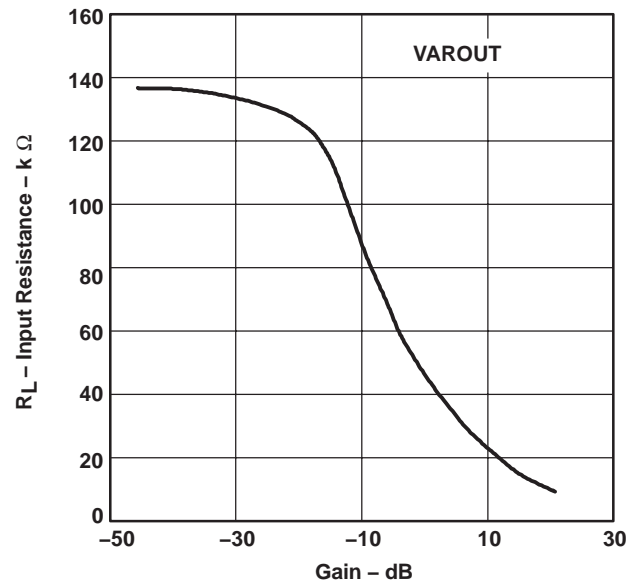
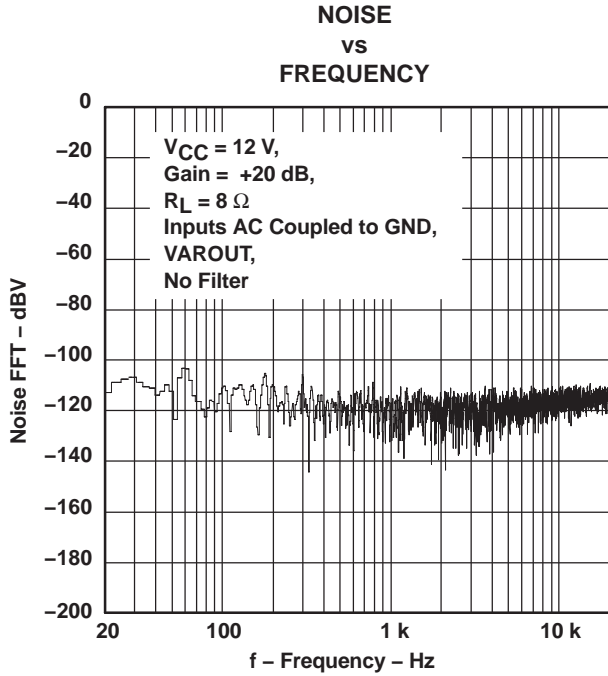
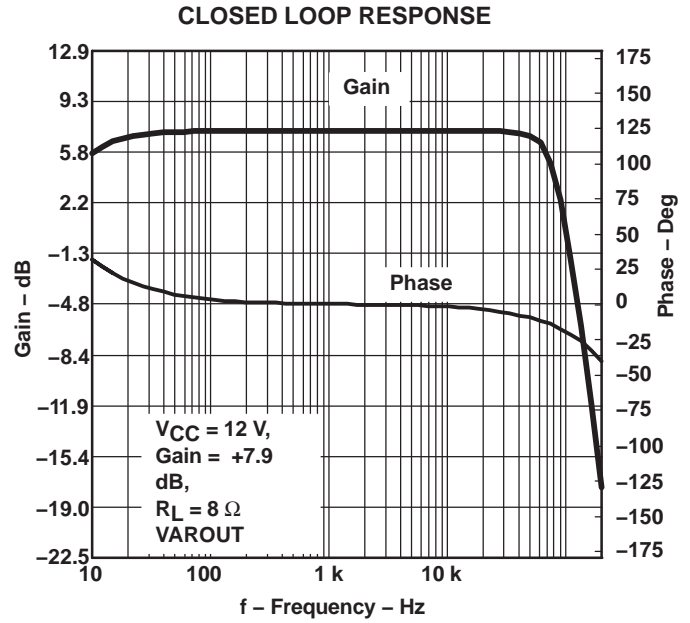

Figure 20



**Figure 21**



**Figure 22**

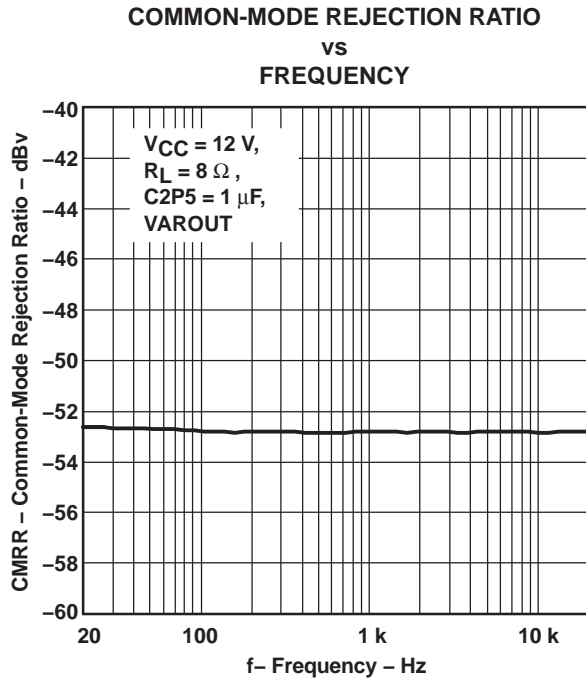

**Figure 23**

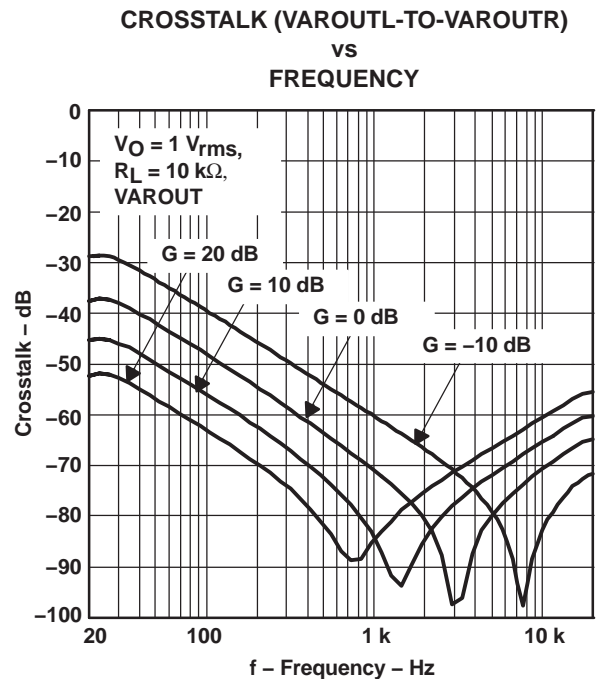

**Figure 24**

TPA3002D2

SLOS402C – DECEMBER 2002 – REVISED JANUARY 2004

TOTAL HARMONIC DISTORTION + NOISE  
vs  
OUTPUT POWER

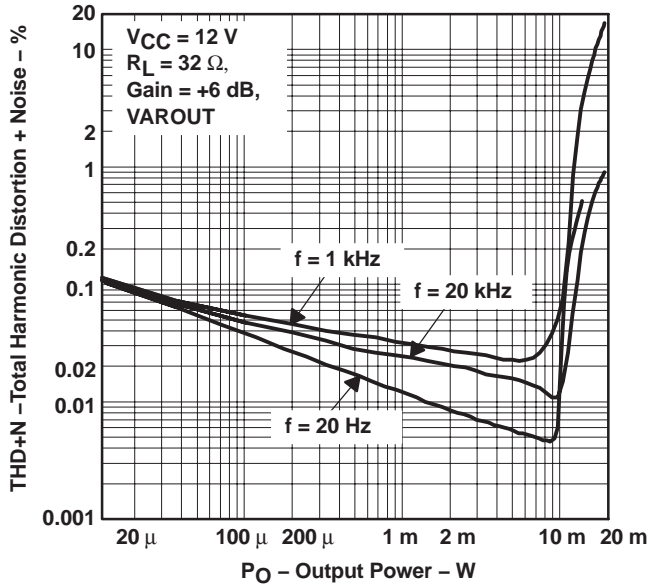

Figure 25

TOTAL HARMONIC DISTORTION + NOISE  
vs  
OUTPUT VOLTAGE

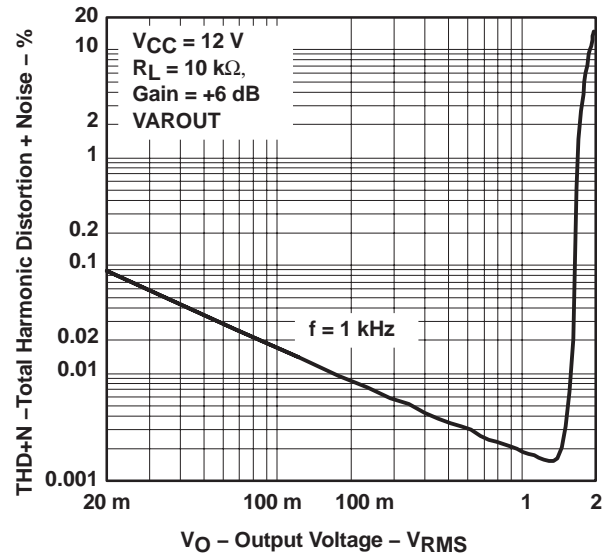

Figure 26

TOTAL HARMONIC DISTORTION + NOISE  
vs  
FREQUENCY

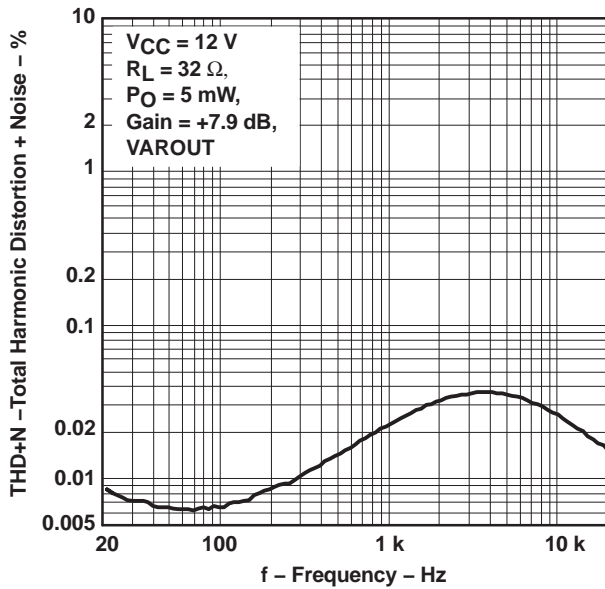

Figure 27

SUPPLY RIPPLE REJECTION RATIO  
vs  
FREQUENCY

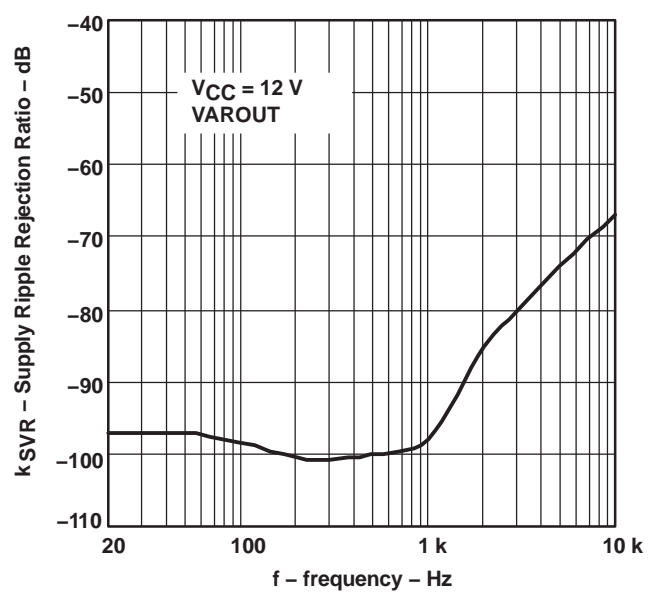
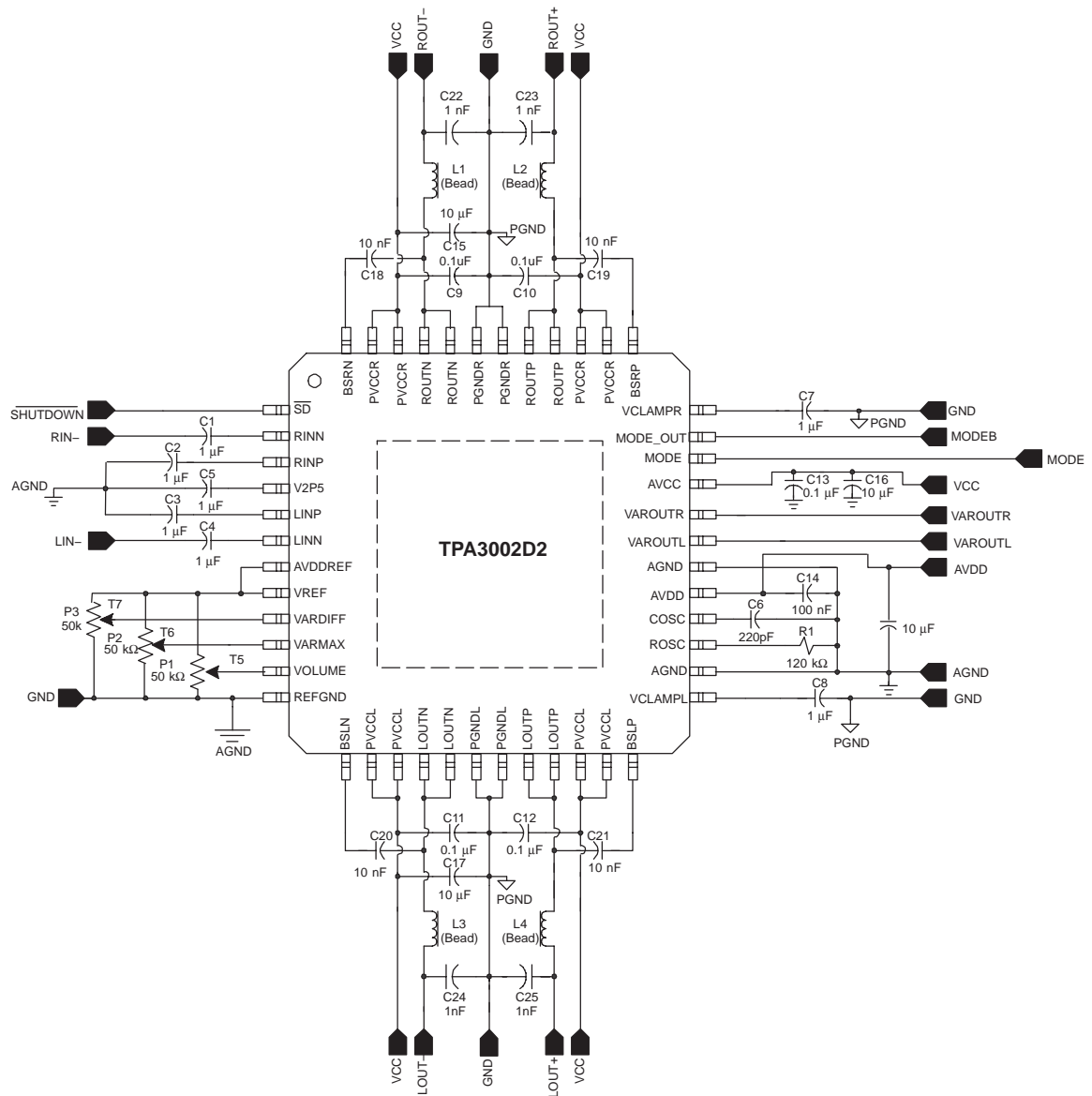

Figure 28



**APPLICATION INFORMATION**



**Figure 29. Stereo Class-D With Single-Ended Inputs**

TPA3002D2

SLOS402C – DECEMBER 2002 – REVISED JANUARY 2004

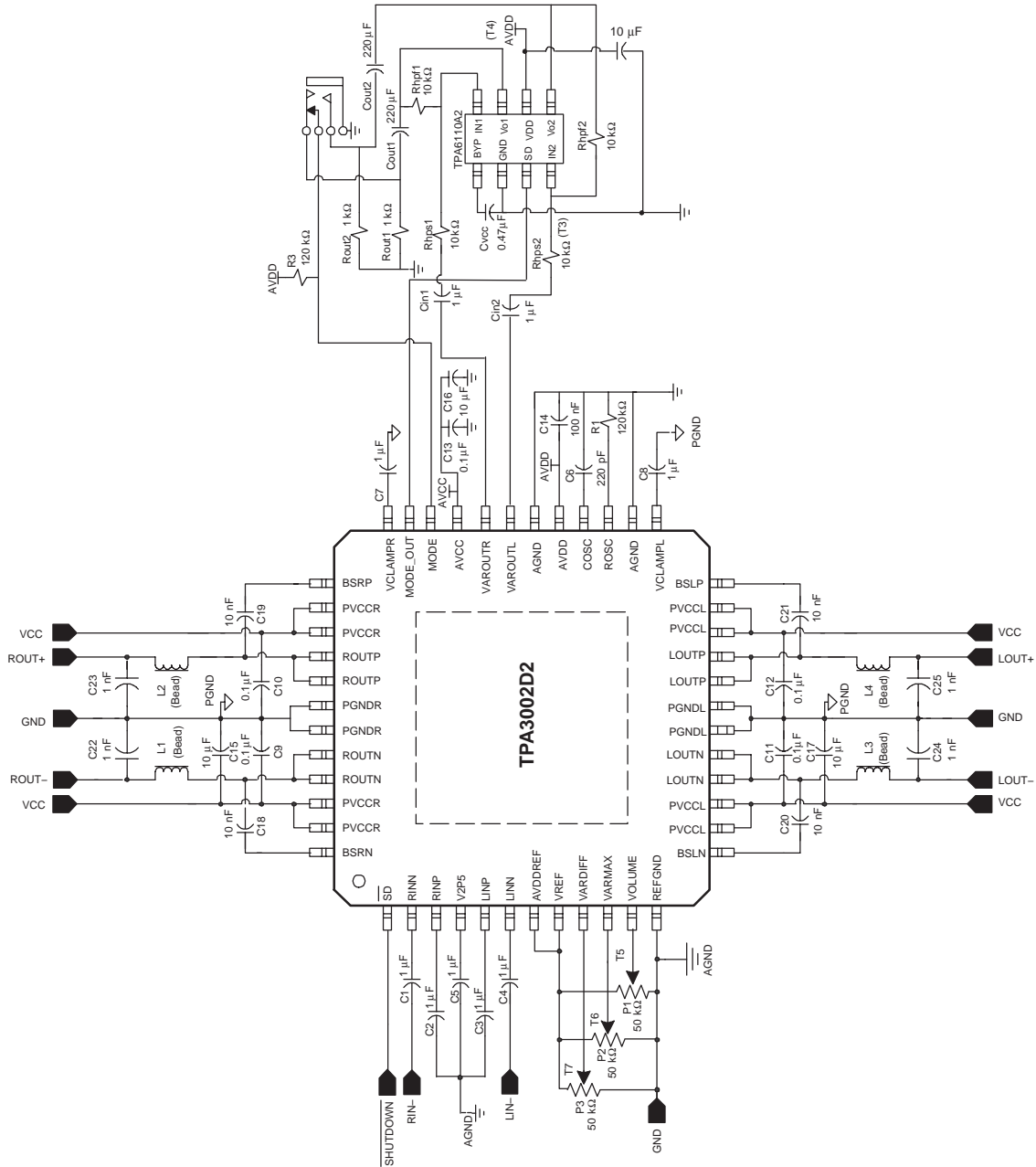

Figure 30. Stereo Class-D With Single-Ended Inputs and Stereo Headphone Amplifier Interface

## CLASS-D OPERATION

This section focuses on the class-D operation of the TPA3002D2.

### Traditional Class-D Modulation Scheme

The traditional class-D modulation scheme, which is used in the TPA032D0x family, has a differential output where each output is 180 degrees out of phase and changes from ground to the supply voltage,  $V_{CC}$ . Therefore, the differential prefiltered output varies between positive and negative  $V_{CC}$ , where filtered 50% duty cycle yields 0 V across the load. The traditional class-D modulation scheme with voltage and current waveforms is shown in Figure 31. Note that even at an average of 0 V across the load (50% duty cycle), the current to the load is high, causing high loss, thus causing a high supply current.

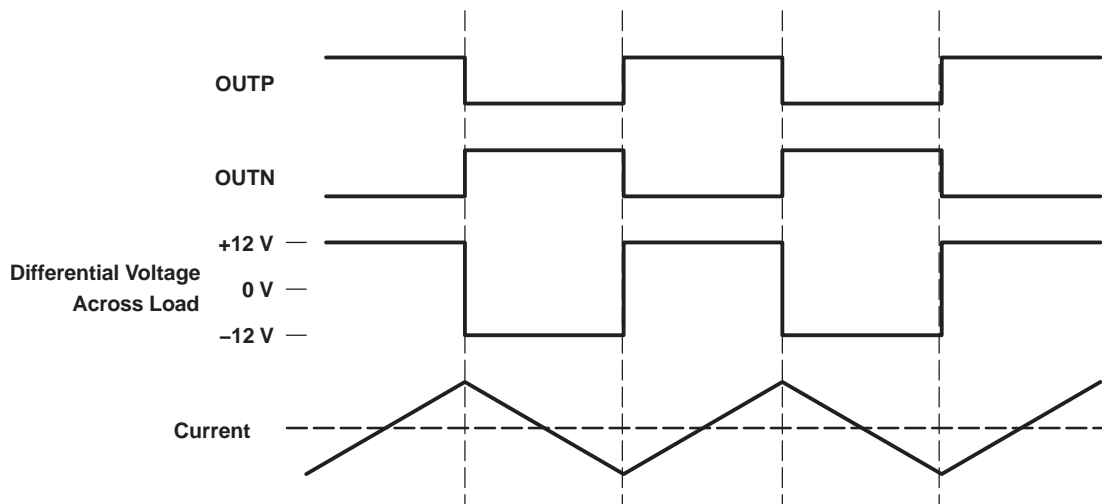

**Figure 31. Traditional Class-D Modulation Scheme's Output Voltage and Current Waveforms Into an Inductive Load With No Input**

### TPA3002D2 Modulation Scheme

The TPA3002D2 uses a modulation scheme that still has each output switching from 0 to the supply voltage. However, OUTP and OUTN are now in phase with each other with no input. The duty cycle of OUTP is greater than 50% and OUTN is less than 50% for positive output voltages. The duty cycle of OUTP is less than 50% and OUTN is greater than 50% for negative output voltages. The voltage across the load sits at 0 V throughout most of the switching period, greatly reducing the switching current, which reduces any  $I^2R$  losses in the load.

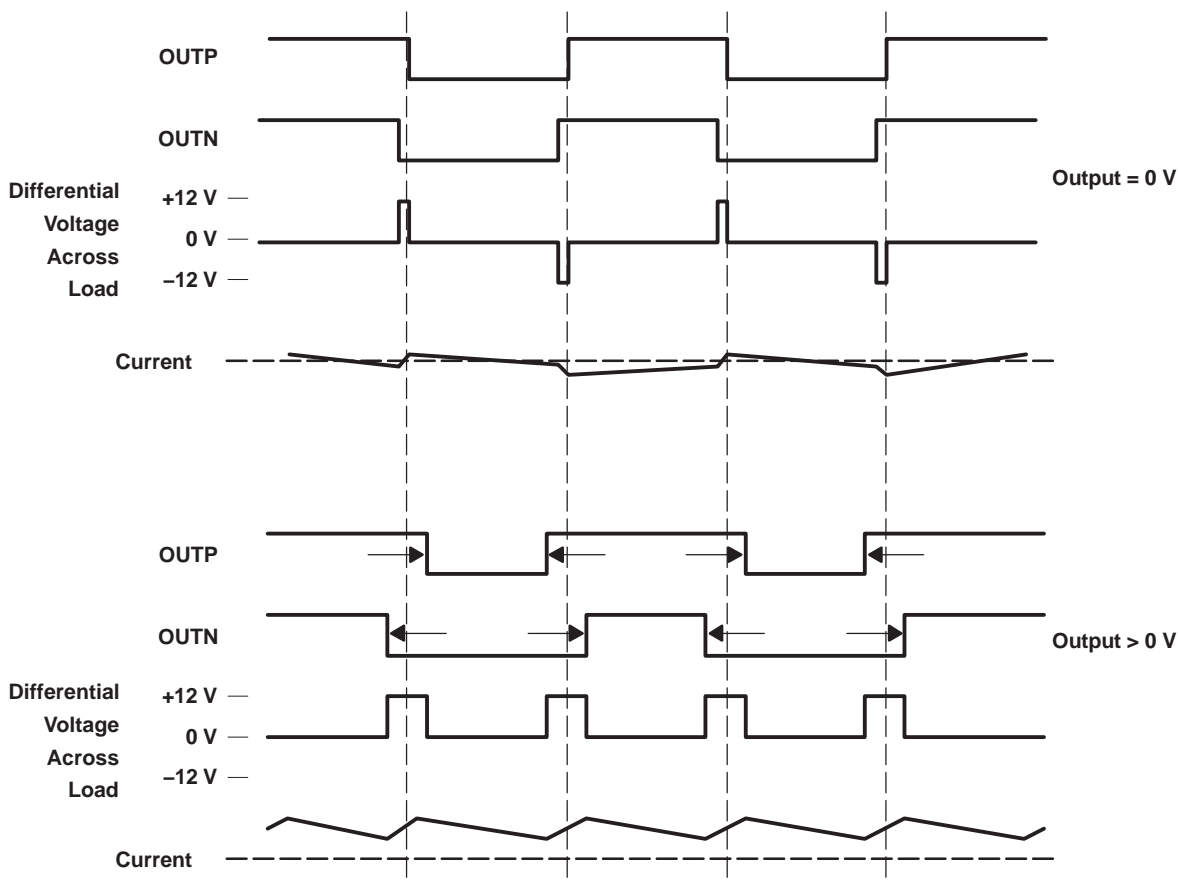

**Figure 32. The TPA3002D2 Output Voltage and Current Waveforms Into an Inductive Load**

### Efficiency: LC Filter Required With the Traditional Class-D Modulation Scheme

The main reason that the traditional class-D amplifier needs an output filter is that the switching waveform results in maximum current flow. This causes more loss in the load, which causes lower efficiency. The ripple current is large for the traditional modulation scheme, because the ripple current is proportional to voltage multiplied by the time at that voltage. The differential voltage swing is  $2 \times V_{CC}$ , and the time at each voltage is half the period for the traditional modulation scheme. An ideal LC filter is needed to store the ripple current from each half cycle for the next half cycle, while any resistance causes power dissipation. The speaker is both resistive and reactive, whereas an LC filter is almost purely reactive.

The TPA3002D2 modulation scheme has very little loss in the load without a filter because the pulses are very short and the change in voltage is  $V_{CC}$  instead of  $2 \times V_{CC}$ . As the output power increases, the pulses widen, making the ripple current larger. Ripple current could be filtered with an LC filter for increased efficiency, but for most applications the filter is not needed.

An LC filter with a cutoff frequency less than the class-D switching frequency allows the switching current to flow through the filter instead of the load. The filter has less resistance than the speaker, which results in less power dissipation, therefore increasing efficiency.

### Effects of Applying a Square Wave Into a Speaker

Audio specialists have advised for years not to apply a square wave to speakers. If the amplitude of the waveform is high enough and the frequency of the square wave is within the bandwidth of the speaker, the square wave could cause the voice coil to jump out of the air gap and/or scar the voice coil. A 250-kHz switching frequency, however, does not significantly move the voice coil, as the cone movement is proportional to  $1/f^2$  for frequencies beyond the audio band.

Damage may occur if the voice coil cannot handle the additional heat generated from the high-frequency switching current. The amount of power dissipated in the speaker may be estimated by first considering the overall efficiency of the system. If the on-resistance ( $r_{ds(on)}$ ) of the output transistors is considered to cause the dominant loss in the system, then the maximum theoretical efficiency for the TPA3002D2 with an 8-Ω load is as follows:

$$\text{Efficiency (theoretical, \%)} = R_L / (R_L + r_{ds(on)}) \times 100\% = 8 / (8 + 0.58) \times 100\% = 93.24\% \quad (1)$$

The maximum measured output power is approximately 7.5 W with an 12-V power supply. The total theoretical power supplied ( $P_{(total)}$ ) for this worst-case condition would therefore be as follows:

$$P_{(total)} = P_O / \text{Efficiency} = 7.5 \text{ W} / 0.9324 = 8.04 \text{ W} \quad (2)$$

The efficiency measured in the lab using an 8-Ω speaker was 89%. The power not accounted for as dissipated across the  $r_{ds(on)}$  may be calculated by simply subtracting the theoretical power from the measured power:

$$\text{Other losses} = P_{(total)}(\text{measured}) - P_{(total)}(\text{theoretical}) = 8.43 - 8.04 = 0.387 \text{ W} \quad (3)$$

The quiescent supply current at 14 V is measured to be 14.3 mA. It can be assumed that the quiescent current encapsulates all remaining losses in the device, i.e., biasing and switching losses. It may be assumed that any remaining power is dissipated in the speaker and is calculated as follows:

$$P_{(dis)} = 0.387 \text{ W} - (14 \text{ V} \times 14.3 \text{ mA}) = 0.19 \text{ W} \quad (4)$$

Note that these calculations are for the worst-case condition of 7.5 W delivered to the speaker. Since the 0.19 W is only 2.5% of the power delivered to the speaker, it may be concluded that the amount of power actually dissipated in the speaker is relatively insignificant. Furthermore, this power dissipated is well within the specifications of most loudspeaker drivers in a system, as the power rating is typically selected to handle the power generated from a clipping waveform.

### When to Use an Output Filter

Design the TPA3002D2 without the filter if the traces from amplifier to speaker are short (< 1 inch). Powered speakers, where the speaker is in the same enclosure as the amplifier, is a typical application for class-D without a filter.

Most applications require a ferrite bead filter. The ferrite filter reduces EMI around 1 MHz and higher (FCC and CE only test radiated emissions greater than 30 MHz). When selecting a ferrite bead, choose one with high impedance at high frequencies, but very low impedance at low frequencies.

Use a LC output filter if there are low frequency (<1 MHz) EMI sensitive circuits and/or there are long wires from the amplifier to the speaker.

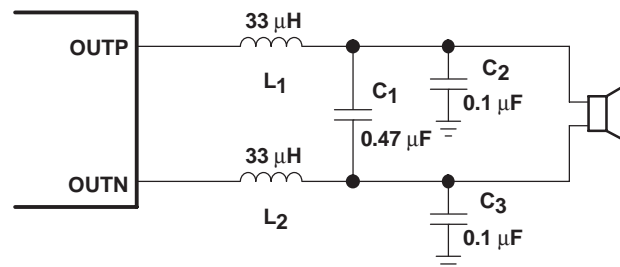
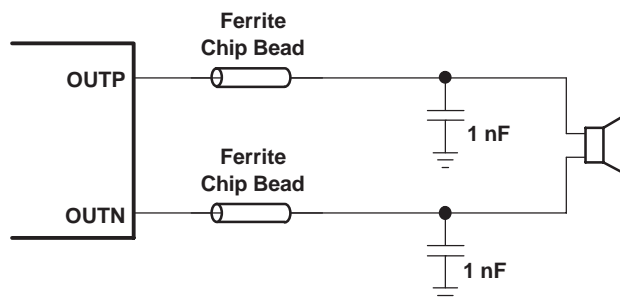

Figure 33. Typical LC Output Filter, Cutoff Frequency of 27 kHz, Speaker Impedance = 8 Ω



**Figure 34. Typical Ferrite Chip Bead Filter (Chip bead example: Fair-Rite 2512067007Y3)**

## VOLUME CONTROL OPERATION

Three pins labeled VOLUME, VARDIFF, and VARMAX control the class-D volume when driving speakers and the VAROUT volume. All of these pins are controlled with a dc voltage, which should not exceed VREF.

When driving speakers in class-D mode, the VOLUME pin is the only pin that controls the gain. Table 1 lists the gain in class-D mode as determined by the voltage on the VOLUME pin in reference to the voltage on VREF.

If using a resistor divider to fix the gain of the amplifier, the VREF terminal can be directly connected to AVDDREF and a resistor divider can be connected across VREF and REFGND. (See Figure 29 in the Applications Section). For fixed gain, calculate the resistor divider values necessary to center the voltage between the two percentage points given in the first column of Table 1. For example, if a gain of 10.7 dB is desired, the resistors in the divider network can both be 10 k $\Omega$ . With these resistor values, a voltage of 50%  $\times$  VREF will be present at the VOLUME pin and result in a class-D gain of 10.7 dB.

If using a DAC to control the class-D gain, VREF and REFGND should be connected to the reference voltage for the DAC and the GND terminal of the DAC, respectively. For the DAC application, AVDDREF would be left unconnected. The reference voltage of the DAC provides the reference to the internal gain circuitry through the VREF input and any fluctuations in the DAC output voltage will not affect the TPA3002D2 gain. The percentages in the first column of Table 1 should be used for setting the voltages of the DAC when the voltage on the VOLUME terminal is increased. The percentages in the second column should be used for the DAC voltages when decreasing the voltage on the VOLUME terminal. Two lookup tables should be used in software to control the gain based on an increase or decrease in the desired system volume. This is explained further in a section below.

If using an analog potentiometer to control the gain, it should be connected between VREF and REFGND. VREF can be connected to AVDDREF or an external voltage source, if desired. The first and second column in Table 1 should be used to determine the point at which the gain changes depending on the direction that the potentiometer is turned. If the voltage on the center tap of the potentiometer is increasing, the first column in Table 1 should be referenced to determine the trip points. If the voltage is decreasing, the trip points in the second column should be referenced.

The trip point, where the gain actually changes, is different depending on whether the voltage on the VOLUME terminal is increasing or decreasing as a result of hysteresis about each trip point. The hysteresis ensures that the gain control is monotonic and does not oscillate from one gain step to another. A pictorial representation of the volume control can be found in Figure 36. The graph focuses on three gain steps with the trip points defined in the first and second columns of Table 1 for class-D gain. The dotted lines represent the hysteresis about each gain step.

## VARDIFF AND VARMAX OPERATION

The TPA3002D2 allows the user to specify a difference between the class-D gain and VAROUT gain. This is desirable to avoid any listening discomfort when plugging in headphones. When interfacing with the variable outputs, the VARDIFF and VARMAX pins control the VAROUT channel gain proportional to the gain set by the voltage on the VOLUME pin. When VARDIFF = 0 V, the difference between the class-D gain and the VAROUT gain is 16 dB. As the voltage on the VARDIFF terminal is increased, the VAROUT channel gain decreases. Internal to the TPA3002D2 device, the voltage on the VARDIFF terminal is subtracted from the voltage on the VOLUME terminal and this value is used to determine the VAROUT gain.

Some audio systems require that the gain be limited in the VAROUT mode to a level that is comfortable for headphone listening. The VARMAX terminal controls the maximum gain for the VAROUT channels.

The functionality of the VARDIFF and VARMAX pin are combined to fix the VAROUT channel gain. A block diagram of the combined functionality is shown in Figure 35. The value obtained from the block diagram for VAROUT\_VOLUME is a DC voltage that can be used in conjunction with Table 2 to determine the VAROUT channel gain. Table 2 lists the gain in VAROUT mode as determined by the VAROUT\_VOLUME voltage in reference to the voltage on VREF.

The timing of the volume control circuitry is controlled by an internal 30 Hz clock. This clock determines the rate at which the gain changes when adjusting the voltage on the external volume control pins. The gain updates every 4 clock cycles (nominally 133 ms based on a 30Hz clock) to the next step until the final desired gain is reached. For example, if the TPA3002D2 is currently in the +0.53 dB class-D gain step and the VOLUME pin is adjusted for maximum gain at +36 dB, the time required for the gain to reach 36dB is 14 steps x 133 ms/step = 1.862 seconds. Referencing Table 1, there are 14 steps between the +0.53 dB gain step and the maximum gain step of +36 dB.

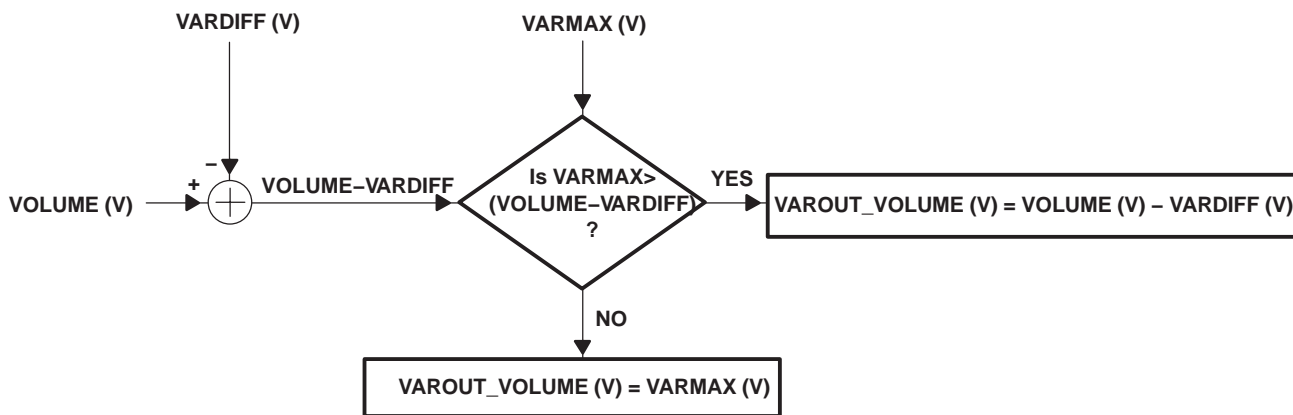

Figure 35. Block Diagram of VAROUT Volume Control

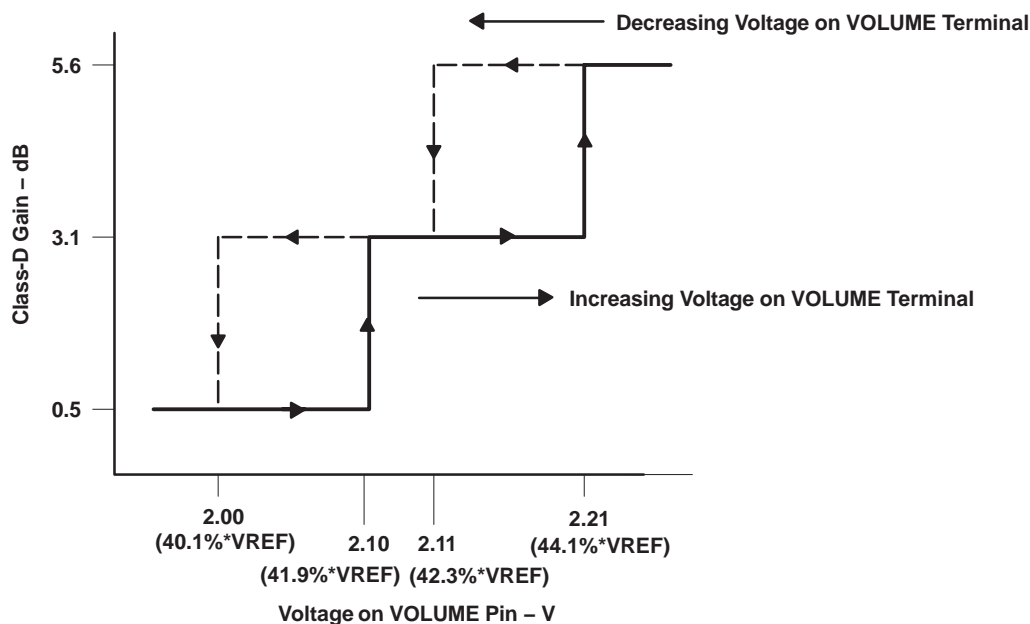

Figure 36. DC Volume Control Operation, VREF = 5 V

## TPA3002D2

SLOS402C – DECEMBER 2002 – REVISED JANUARY 2004

### MODE OPERATION

The MODE pin is an input for controlling the output mode of the TPA3002D2. A logic HIGH on this pin disables the Class-D outputs. A logic LOW on this pin enables the class-D outputs. The VAROUT outputs are active in both modes and can be used as line level inputs to an external powered subwoofer while driving internal stereo speakers with the class-D outputs. The trip levels are defined in the specifications table.

For interfacing with an external headphone amplifier like the TPA6110A2, the MODE pin can be connected to the switch on a headphone jack. When configured like Figure 30, the class-D outputs will be disabled when a headphone plug is inserted into the headphone jack.

### MODE\_OUT OPERATION

for controlling the SHUTDOWN pin on an external headphone amplifier like the TPA6110A2 or for interfacing with other logic. The output voltages for a given load condition are given in the specifications table.

This output is controlled by the MODE pin logic. When the MODE input is driven to a logic low, the MODE\_OUT output drives to a logic high. Conversely, when the MODE pin is driven to a logic high, the MODE\_OUT output drives LOW. The MODE\_OUT output is simply the inverted state of the MODE input.

It is designed in this manner because the TPA6110A2 SHUTDOWN input is active high. This allows the TPA3002D2 to place the TPA6110A2 into the shutdown state when driving internal speakers in the Class-D mode. Conversely, the MODE\_OUT pin drives low to enable the TPA6110A2 headphone amplifier when headphones are plugged into the headphone jack and the MODE input is driven high.

### SELECTION OF COSC AND ROSC

The switching frequency is determined using the values of the components connected to ROSC (pin 27) and COSC (pin 28) and may be calculated with the following equation:

$$f_{osc} = 6.6 / (R_{osc} * C_{osc})$$

### INTERNAL 2.5-V BIAS GENERATOR CAPACITOR SELECTION

The internal 2.5-V bias generator (V2P5) provides the internal bias for the preamplifier stages on both the class-D amplifiers and the variable amplifiers. The external input capacitors and this internal reference allow the inputs to be biased within the optimal common-mode range of the input preamplifiers.

The selection of the capacitor value on the V2P5 terminal is critical for achieving the best device performance. During startup or recovery from the shutdown state, the V2P5 capacitor determines the rate at which the amplifier starts up. When the voltage on the V2P5 capacitor equals  $0.75 \times V_{2P5}$ , or 75% of its final value, the device turns on and the class-D outputs start switching. The startup time is not critical for the best depop performance since any pop sound that is heard is the result of the class-D outputs switching on and not the startup time. However, at least a 0.47- $\mu$ F capacitor is recommended for the V2P5 capacitor.

A secondary function of the V2P5 capacitor is to filter high frequency noise on the internal 2.5-V bias generator.

### INPUT RESISTANCE

Each gain setting is achieved by varying the input resistance of the amplifier, which can range from its smallest value to over six times that value. As a result, if a single capacitor is used in the input high-pass filter, the -3 dB or cutoff frequency also changes by over six times.

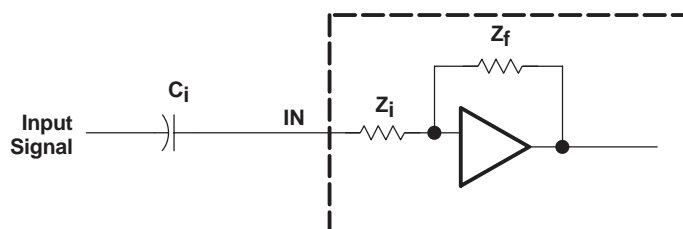

The -3-dB frequency can be calculated using equation 5. Input impedance ( $Z_i$ ) vs Gain can be found in Figure 7.



$$f_{-3\text{dB}} = \frac{1}{2\pi Z_i C_i} \quad (5)$$

### INPUT CAPACITOR, $C_i$

In the typical application an input capacitor ( $C_i$ ) is required to allow the amplifier to bias the input signal to the proper dc level (V2P5) for optimum operation. In this case,  $C_i$  and the input impedance of the amplifier ( $Z_i$ ) form a high-pass filter with the corner frequency determined in equation 6.

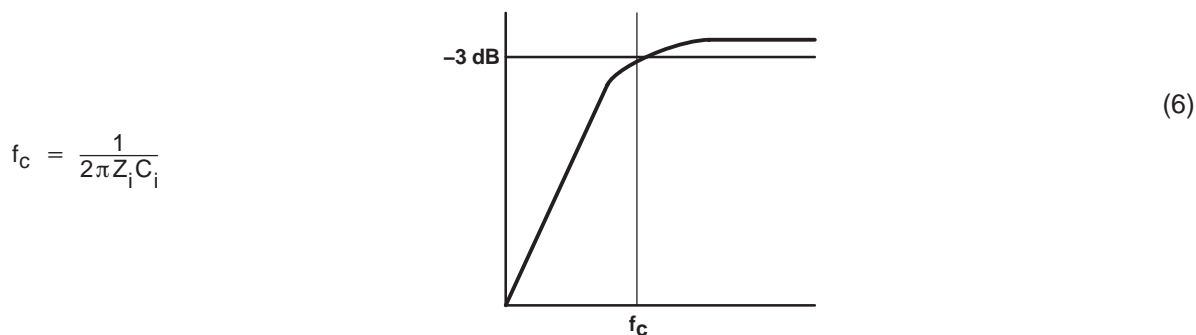

The value of  $C_i$  is important, as it directly affects the bass (low frequency) performance of the circuit. Consider the example where  $Z_i$  is 20 k $\Omega$  and the specification calls for a flat bass response down to 20 Hz. Equation 6 is reconfigured as equation 7.

$$C_i = \frac{1}{2\pi Z_i f_c} \quad (7)$$

In this example,  $C_i$  is 0.4  $\mu\text{F}$ , so one would likely choose a value in the range of 0.47  $\mu\text{F}$  to 1  $\mu\text{F}$ . If the gain is known and will be constant, use  $Z_i$  from Figure 7 (Input Impedance vs Gain) to calculate  $C_i$ . Calculations for  $C_i$  should be based off the impedance at the lowest gain step intended for use in the system. A further consideration for this capacitor is the leakage path from the input source through the input network ( $C_i$ ) and the feedback network to the load. This leakage current creates a dc offset voltage at the input to the amplifier that reduces useful headroom, especially in high gain applications. For this reason a low-leakage tantalum or ceramic capacitor is the best choice. When polarized capacitors are used, the positive side of the capacitor should face the amplifier input in most applications as the dc level there is held at 2.5 V, which is likely higher than the source dc level. Note that it is important to confirm the capacitor polarity in the application.

### Power Supply Decoupling, $C_S$

The TPA3002D2 is a high-performance CMOS audio amplifier that requires adequate power supply decoupling to ensure the output total harmonic distortion (THD) is as low as possible. Power supply decoupling also prevents oscillations for long lead lengths between the amplifier and the speaker. The optimum decoupling is achieved by using two capacitors of different types that target different types of noise on the power supply leads. For higher frequency transients, spikes, or digital hash on the line, a good low equivalent-series-resistance (ESR) ceramic capacitor, typically 0.1  $\mu\text{F}$  placed as close as possible to the device  $V_{CC}$  lead works best. For filtering lower-frequency noise signals, a larger aluminum electrolytic capacitor of 10  $\mu\text{F}$  or greater placed near the audio power amplifier is recommended. The 10- $\mu\text{F}$  capacitor also serves as local storage capacitor for supplying current during large signal transients on the amplifier outputs.

### BSN and BSP Capacitors

The full H-bridge output stages use only NMOS transistors. They therefore require bootstrap capacitors for the high side of each output to turn on correctly. A 10-nF ceramic capacitor, rated for at least 25 V, must be connected from each output to its corresponding bootstrap input. Specifically, one 10-nF capacitor must be connected from xOUTP to xBSP, and one 10-nF capacitor must be connected from xOUTN to xBSN. (See the application circuit diagram in Figure 29.)

The bootstrap capacitors connected between the BSxx pins and corresponding output function as a floating power supply for the high-side N-channel power MOSFET gate drive circuitry. During each high-side switching cycle, the bootstrap capacitors attempt to hold the gate-to-source voltage high enough to keep the high-side MOSFETs turned on. However, there is a leakage path and the voltage on the bootstrap capacitors slowly decrease while the high-side is conducting.

By driving the outputs into heavy clipping with a sine wave of less than 50 Hz, the bootstrap voltage can decrease below the minimum  $V_{GS}$  required to keep the high-side output MOSFET turned on. When this occurs, the output transistor becomes a source-follower and the output drops from  $V_{CC}$  to approximately  $V_{clamp}$  (voltage on pins 25 and 36).

For the majority of applications, driving a square wave at low frequencies is not a design consideration and the recommended bootstrap capacitor value of 10 nF is acceptable. However, if this is a concern, increasing the bootstrap capacitors holds the gate voltage for a longer period of time and the drop in the output voltage does not occur. A value of 220 nF is recommended with a 51  $\Omega$  resistor placed in series between the outputs and bootstrap pins. The 51  $\Omega$  series resistor is necessary to limit the current charging and discharging the bootstrap capacitors.

### VCLAMP Capacitors

To ensure that the maximum gate-to-source voltage for the NMOS output transistors is not exceeded, two internal regulators clamp the gate voltage. Two 1- $\mu$ F capacitors must be connected from VCLAMPL (pin 25) and VCLAMPR (pin 36) to ground and must be rated for at least 25 V. The voltages at the VCLAMP terminals vary with  $V_{CC}$  and may not be used for powering any other circuitry.

### Internal Regulated 5-V Supply ( $AV_{DD}$ )

The  $AV_{DD}$  terminal (pin 29) is the output of an internally-generated 5-V supply, used for the oscillator, preamplifier, and volume control circuitry. It requires a 0.1- $\mu$ F to 1- $\mu$ F capacitor, placed very close to the pin, to ground to keep the regulator stable. The regulator may be used to power an external headphone amplifier or other circuitry, up to a current limit specified in the specification table. When powering external circuitry, like the TPA6110A2 headphone amplifier, an additional 10  $\mu$ F or larger capacitor should be added to the  $AV_{DD}$  terminal.

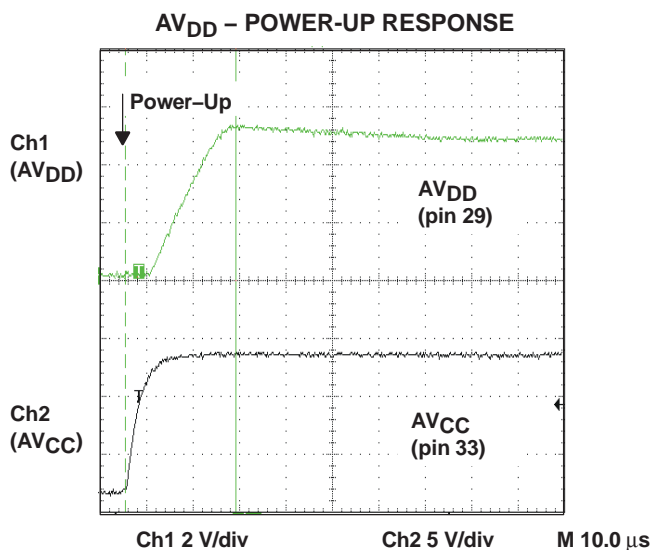

**Figure 37. Power-Up Response**

### Differential Input

The differential input stage of the amplifier cancels any noise that appears on both input lines of the channel. To use the TPA3002D2 EVM with a differential source, connect the positive lead of the audio source to the INP input and the negative lead from the audio source to the INN input. To use the TPA3002D2 with a single-ended source, ac ground the INP input through a capacitor equal in value to the input capacitor on INN and apply the audio source to the INN input. In a single-ended input application, the INP input should be ac-grounded at the audio source instead of at the device input for best noise performance.

## **SD OPERATION**

The TPA3002D2 employs a shutdown mode of operation designed to reduce supply current ( $I_{CC}$ ) to the absolute minimum level during periods of nonuse for power conservation. The  $\overline{SD}$  input terminal should be held high (see specification table for trip point) during normal operation when the amplifier is in use. Pulling  $\overline{SD}$  low causes the outputs to mute and the amplifier to enter a low-current state,  $I_{CC(SD)} = 10 \mu\text{A}$ .  $\overline{SD}$  should never be left unconnected, because amplifier operation would be unpredictable.

## **POWER-OFF POP REDUCTION**

For the best power-off pop performance, the amplifier should be placed in the shutdown mode prior to removing the power supply voltage.

Another method to reduce power-off pop can be implemented in the hardware. A 100- $\mu\text{F}$  – 150- $\mu\text{F}$  capacitor can be added to the  $AV_{DD}$  terminal in parallel with the 100-nF capacitor shown in Figure 29. The additional capacitance holds up the regulator voltage for a longer period of time and results in smaller power-off pop.

## **USING LOW-ESR CAPACITORS**

Low-ESR capacitors are recommended throughout this application section. A real (as opposed to ideal) capacitor can be modeled simply as a resistor in series with an ideal capacitor. The voltage drop across this resistor minimizes the beneficial effects of the capacitor in the circuit. The lower the equivalent value of this resistance the more the real capacitor behaves like an ideal capacitor.

## **SHORT-CIRCUIT PROTECTION**

The TPA3002D2 has short circuit protection circuitry on the outputs that prevents damage to the device during output-to-output shorts, output-to-GND shorts, and output-to- $V_{CC}$  shorts. When a short-circuit is detected on the outputs, the part immediately disables the output drive. This is a latched fault and must be reset by cycling the voltage on the  $\overline{SD}$  pin to a logic low and back to the logic high state for normal operation. This will clear the short-circuit flag and allow for normal operation if the short was removed. If the short was not removed, the protection circuitry will again activate.

The trip-point for the short-circuit protection is nominally set at 8 A. However, this trip point can vary with PCB layout and the separation of  $AV_{CC}$  and  $PV_{CC}$ . It is important to connect the  $AV_{CC}$  pin as close as possible to all of the  $PV_{CC}$  pins with a wide (>20 mils) trace. This minimizes the inductance between the two pins and allows the short-circuit protection to trip at the nominal current. If the inductance between these two pins is large, the short-circuit protection may inadvertently trip when drive low impedance loads into heavy clipping.

## **THERMAL PROTECTION**

Thermal protection on the TPA3002D2 prevents damage to the device when the internal die temperature exceeds 150°C. There is a  $\pm 15$  degree tolerance on this trip point from device to device. Once the die temperature exceeds the thermal set point, the device enters into the shutdown state and the outputs are disabled. This is not a latched fault. The thermal fault is cleared once the temperature of the die is reduced by 20°C. The device begins normal operation at this point with no external system interaction.

## **THERMAL CONSIDERATIONS: OUTPUT POWER AND MAXIMUM AMBIENT TEMPERATURE**

To calculate the maximum ambient temperature, the following equation may be used:

$$T_{Amax} = T_{Jmax} - \Theta_{JA} P_{Dissipated}$$

where:  $T_{Jmax} = 150^{\circ}\text{C}$

$$\Theta_{JA} = 19^{\circ}\text{C/W} \quad (2\text{-Layer PCB, } 5 \text{ sq. in. copper, see Figure 38)} \quad (8)$$

To estimate the power dissipation, the following equation may be used:

$$P_{Dissipated} = P_{O(average)} \times ((1 / \text{Efficiency}) - 1)$$

$$\begin{aligned} \text{Efficiency} &= \sim 85\% \text{ for an } 8\text{-}\Omega \text{ load} \\ &= \sim 75\% \text{ for a } 4\text{-}\Omega \text{ load} \end{aligned} \quad (9)$$

## TPA3002D2

SLOS402C – DECEMBER 2002 – REVISED JANUARY 2004

---

Example. What is the maximum ambient temperature for an application that requires the TPA3002D2 to drive 7.5 W into stereo 8-Ω speakers?

$$P_{\text{Dissipated}} = 15 \text{ W} \times ((1 / 0.85) - 1) = 2.65 \text{ W} \quad (P_O = 7.5 \text{ W} \times 2)$$

$$T_{\text{Amax}} = 150^\circ\text{C} - (19^\circ\text{C/W} \times 2.65 \text{ W}) = 99.65^\circ\text{C}$$

This calculation shows that the TPA3002D2 can drive 7.5 W into an 8-Ω speaker up to the absolute maximum ambient temperature rating of 85°C, which must never be exceeded.

Figure 38 and Figure 39 show the results of several thermal experiments conducted with the TPA3002D2. Both figures show that the best thermal performance can be achieved with more copper area for heat dissipation and an adequate number of thermal vias.

Figure 38 shows two curves for a 2-layer and 4-layer PCB. The 2-layer PCB layout was tightly controlled with a fixed amount of 2 oz. copper on the bottom layer of the PCB. The amount of copper is shown on the x-axis. Nine thermal vias of 13 mil (0,33 mm) diameter were drilled under the PowerPad and connected to the bottom layer. The top layer only consisted of traces for signal routing.

The 4-layer PCB layout was also tightly controlled with a fixed amount of 2 oz. copper in middle GND layer. The top layer only consisted of traces for signal routing. The bottom and other middle layer were left blank. Nine thermal vias of 0,33 mm diameter were drilled under the PowerPAD and connected to the middle layer.

Figure 39 shows the effect of the number of thermal vias drilled under the PowerPAD on the thermal performance of the PCB. The experiment was conducted with a 2-layer PCB and 3 square inches of copper on the bottom layer. For the best thermal performance, at least 16 vias in a 4x4 pattern should be used under the PowerPAD. Refer to the TPA3002D2 EVM User's Manual (SLOU151), for an example layout with a 4x4 via pattern. PCB gerber files are available at request.

## PRINTED CIRCUIT BOARD (PCB) LAYOUT

Because the TPA3002D2 is a class-D amplifier that switches at a high frequency, the layout of the printed circuit board (PCB) should be optimized according to the following guidelines for the best possible performance.

- Decoupling capacitors — As described on page 28, the high-frequency 0.1- $\mu$ F decoupling capacitors should be placed as close to the PVCC (pin 14, 15, 22, 23, 38, 39, 46, 47) and AV<sub>CC</sub> (pin 33) terminals as possible. The V2P5 (pin 4) capacitor, AV<sub>DD</sub> (pin 29) capacitor, and VCLAMP (pins 25, 36) capacitor should also be placed as close to the device as possible. Large (10  $\mu$ F or greater) bulk power supply decoupling capacitors should be placed near the TPA3002D2 on the PVCCL, PVCCR, and AV<sub>CC</sub> terminals.
- Grounding — The AV<sub>CC</sub> (pin 33) decoupling capacitor, AV<sub>DD</sub> (pin 29) capacitor, V2P5 (pin 4) capacitor, COSC (pin 28) capacitor, and ROSC (pin 27) resistor should each be grounded to analog ground (AGND, pin 26 and pin 30). The PVCC (pin 9 and pin 16) decoupling capacitors should each be grounded to power ground (PGND, pins 18, 19, 42, 43). Analog ground and power ground may be connected at the PowerPAD, which should be used as a central ground connection or star ground for the TPA3002D2. Basically, an island should be created with a single connection to PGND at the PowerPAD.
- Output filter — The ferrite EMI filter (Figure 34) should be placed as close to the output terminals as possible for the best EMI performance. The LC filter (Figure 33) should be placed close to the outputs. The capacitors used in both the ferrite and LC filters should be grounded to power ground.
- PowerPAD — The PowerPAD must be soldered to the PCB for proper thermal performance and optimal reliability. The dimensions of the PowerPAD thermal land should be 5 mm by 5 mm (197 mils by 197 mils). The PowerPAD size measures 4,55 x 4,55 mm. Four rows of solid vias (four vias per row, 0,3302 mm or 13 mils diameter) should be equally spaced underneath the thermal land. The vias should connect to a solid copper plane, either on an internal layer or on the bottom layer of the PCB. The vias must be solid vias, not thermal relief or webbed vias. For additional information, please refer to the *PowerPAD Thermally Enhanced Package* application note (SLMA002).

For an example layout, refer to the TPA3002D2 Evaluation Module (TPA3002D2EVM) User Manual (SLOU151). Both the EVM user manual and the PowerPAD application note are available on the TI web site at <http://www.ti.com>.

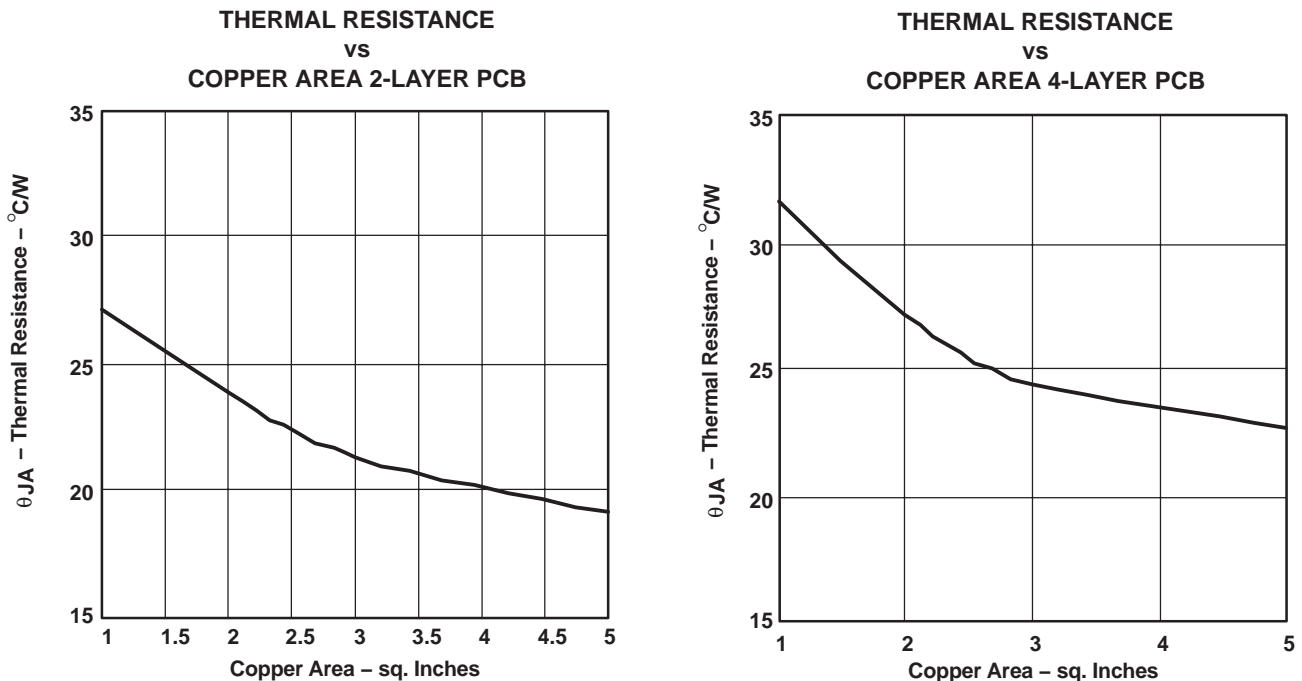
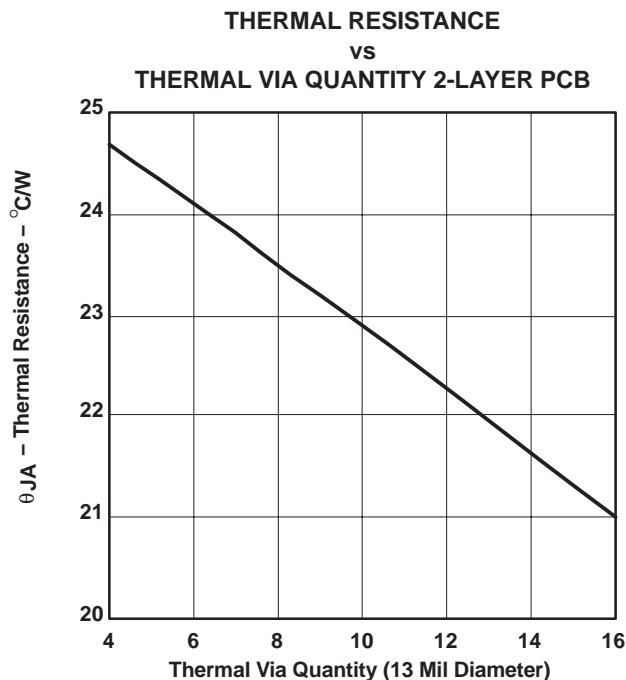

Figure 38. Thermal Resistance



**Figure 39. Thermal Resistance**

## BASIC MEASUREMENT SYSTEM

This application note focuses on methods that use the basic equipment listed below:

- Audio analyzer or spectrum analyzer
- Digital multimeter (DMM)
- Oscilloscope
- Twisted pair wires
- Signal generator
- Power resistor(s)
- Linear regulated power supply
- Filter components
- EVM or other complete audio circuit

Figure 40 shows the block diagrams of basic measurement systems for class-AB and class-D amplifiers. A sine wave is normally used as the input signal since it consists of the fundamental frequency only (no other harmonics are present). An analyzer is then connected to the APA output to measure the voltage output. The analyzer must be capable of measuring the entire audio bandwidth. A regulated dc power supply is used to reduce the noise and distortion injected into the APA through the power pins. A System Two audio measurement system (AP-II) (Reference 1) by Audio Precision includes the signal generator and analyzer in one package.

The generator output and amplifier input must be ac-coupled. However, the EVMs already have the ac-coupling capacitors, ( $C_{IN}$ ), so no additional coupling is required. The generator output impedance should be low to avoid attenuating the test signal, and is important since the input resistance of APAs is not very high (about 10 k $\Omega$ ). Conversely the analyzer-input impedance should be high. The output impedance,  $R_{OUT}$ , of the APA is normally in the hundreds of milliohms and can be ignored for all but the power-related calculations.

Figure 40(a) shows a class-AB amplifier system. They take an analog signal input and produce an analog signal output. These amplifier circuits can be directly connected to the AP-II or other analyzer input.

This is not true of the class-D amplifier system shown in Figure 40(b), which requires low pass filters in most cases in order to measure the audio output waveforms. This is because it takes an analog input signal and converts it into a pulse-width modulated (PWM) output signal that is not accurately processed by some analyzers.

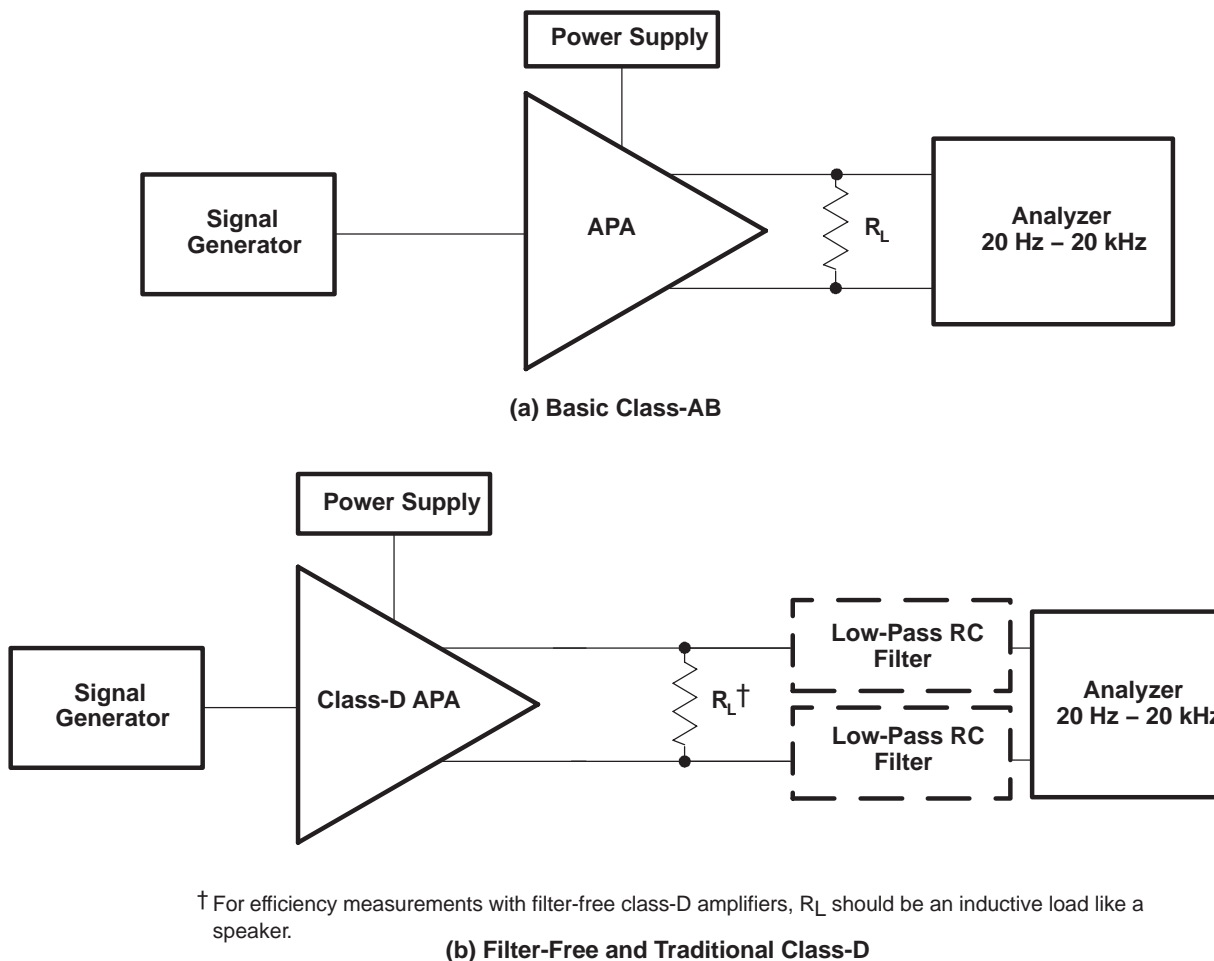

**Figure 40. Audio Measurement Systems**

The TPA3002D2 uses a modulation scheme that does not require an output filter for operation, but they do sometimes require an RC low-pass filter when making measurements. This is because some analyzer inputs cannot accurately process the rapidly changing square-wave output and therefore record an extremely high level of distortion. The RC low-pass measurement filter is used to remove the modulated waveforms so the analyzer can measure the output sine wave.

## DIFFERENTIAL INPUT AND BTL OUTPUT

All of the class-D APAs and many class-AB APAs have differential inputs and bridge-tied load (BTL) outputs. Differential inputs have two input pins per channel and amplify the difference in voltage between the pins. Differential inputs reduce the common-mode noise and distortion of the input circuit. BTL is a term commonly used in audio to describe differential outputs. BTL outputs have two output pins providing voltages that are 180 degrees out of phase. The load is connected between these pins. This has the added benefits of quadrupling the output power to the load and eliminating a dc blocking capacitor.

A block diagram of the measurement circuit is shown in Figure 41. The differential input is a balanced input, meaning the positive (+) and negative (–) pins will have the same impedance to ground. Similarly, the BTL output equates to a balanced output.



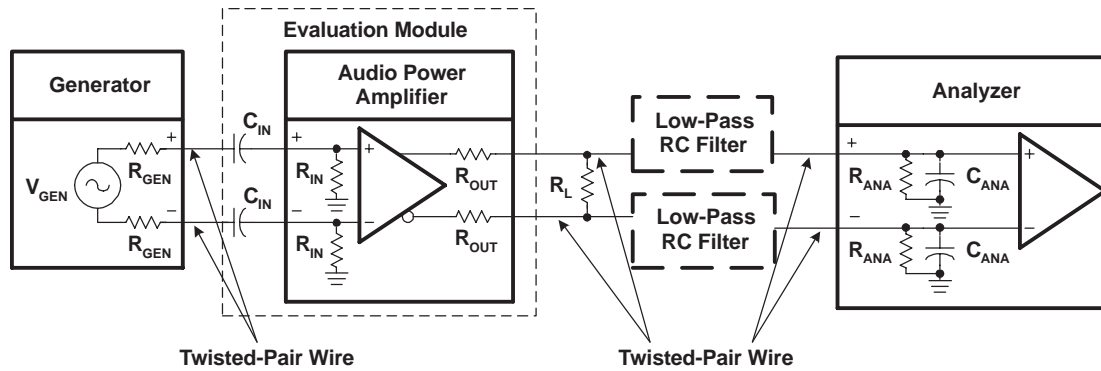

**Figure 41. Differential Input—BTL output Measurement Circuit**

The generator should have balanced outputs and the signal should be balanced for best results. An unbalanced output can be used, but it may create a ground loop that will affect the measurement accuracy. The analyzer must also have balanced inputs for the system to be fully balanced, thereby cancelling out any common mode noise in the circuit and providing the most accurate measurement.

The following general rules should be followed when connecting to APAs with differential inputs and BTL outputs:

- Use a balanced source to supply the input signal.
- Use an analyzer with balanced inputs.
- Use twisted-pair wire for all connections.
- Use shielding when the system environment is noisy.
- Ensure the cables from the power supply to the APA, and from the APA to the load, can handle the large currents (see Table 3).

Table 3 shows the recommended wire size for the power supply and load cables of the APA system. The real concern is the dc or ac power loss that occurs as the current flows through the cable. These recommendations are based on 12-inch long wire with a 20-kHz sine-wave signal at 25°C.

**Table 3. Recommended Minimum Wire Size for Power Cables**

P <sub>OUT</sub> (W)	R <sub>L</sub> (Ω)	AWG SIZE	DC POWER LOSS (MW)	AC POWER LOSS (MW)
10	4	18 22	16 40	18 42
2	4	18 22	3.2 8.0	3.7 8.5
1	8	22 28	2.0 8.0	2.1 8.1
< 0.75	8	22 28	1.5 6.1	1.6 6.2

## CLASS-D RC LOW-PASS FILTER

An RC filter is used to reduce the square-wave output when the analyzer inputs cannot process the pulse-width modulated class-D output waveform. This filter has little effect on the measurement accuracy because the cutoff frequency is set above the audio band. The high frequency of the square wave has negligible impact on measurement accuracy because it is well above the audible frequency range and the speaker cone cannot respond at such a fast rate. The RC filter is not required when an LC low-pass filter is used, such as with the class-D APAs that employ the traditional modulation scheme (TPA032D0x, TPA005Dxx).

The component values of the RC filter are selected using the equivalent output circuit as shown in Figure 42. R<sub>L</sub> is the load impedance that the APA is driving for the test. The analyzer input impedance specifications should be available and substituted for R<sub>ANA</sub> and C<sub>ANA</sub>. The filter components, R<sub>FILT</sub> and C<sub>FILT</sub>, can then be derived for the system. The filter should be grounded to the APA near the output ground pins or at the power supply ground pin to minimize ground loops.



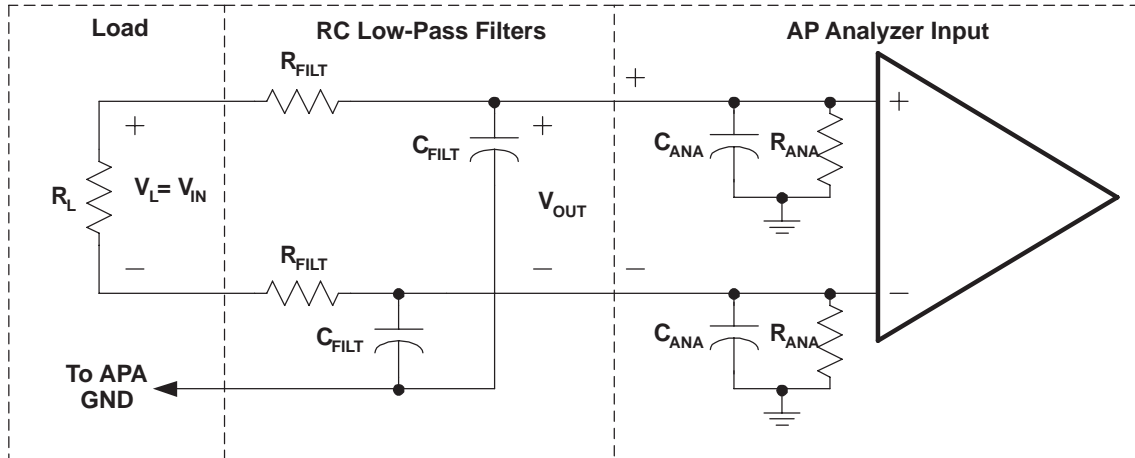

Figure 42. Measurement Low-Pass Filter Derivation Circuit—Class-D APAs

The transfer function for this circuit is shown in equation (10) where  $\omega_O = R_{EQ}C_{EQ}$ ,  $R_{EQ} = R_{FILT} \parallel R_{ANA}$  and  $C_{EQ} = (C_{FILT} + C_{ANA})$ . The filter frequency should be set above  $f_{MAX}$ , the highest frequency of the measurement bandwidth, to avoid attenuating the audio signal. Equation (11) provides this cutoff frequency,  $f_C$ . The value of  $R_{FILT}$  must be chosen large enough to minimize current that is shunted from the load, yet small enough to minimize the attenuation of the analyzer-input voltage through the voltage divider formed by  $R_{FILT}$  and  $R_{ANA}$ . A rule of thumb is that  $R_{FILT}$  should be small ( $\sim 100 \Omega$ ) for most measurements. This reduces the measurement error to less than 1% for  $R_{ANA} \geq 10 \text{ k}\Omega$ .

$$\left(\frac{V_{OUT}}{V_{IN}}\right) = \frac{\left(\frac{R_{ANA}}{R_{ANA} + R_{FILT}}\right)}{1 + j\left(\frac{\omega}{\omega_O}\right)} \quad (10)$$

$$f_C = \sqrt{2} \times f_{MAX} \quad (11)$$

An exception occurs with the efficiency measurements, where  $R_{FILT}$  must be increased by a factor of ten to reduce the current shunted through the filter.  $C_{FILT}$  must be decreased by a factor of ten to maintain the same cutoff frequency. See Table 4 for the recommended filter component values.

Once  $f_C$  is determined and  $R_{FILT}$  is selected, the filter capacitance is calculated using equation (12). When the calculated value is not available, it is better to choose a smaller capacitance value to keep  $f_C$  above the minimum desired value calculated in equation (11).

$$C_{FILT} = \frac{1}{2\pi \times f_C \times R_{FILT}} \quad (12)$$

Table 4 shows recommended values of  $R_{FILT}$  and  $C_{FILT}$  based on common component values. The value of  $f_C$  was originally calculated to be 28 kHz for an  $f_{MAX}$  of 20 kHz.  $C_{FILT}$ , however, was calculated to be 57000 pF, but the nearest values of 56000 pF and 51000 pF were not available. A 47000 pF capacitor was used instead, and  $f_C$  is 34 kHz, which is above the desired value of 28 kHz.

Table 4. Typical RC Measurement Filter Values

MEASUREMENT	$R_{FILT}$	$C_{FILT}$
Efficiency	1 000 $\Omega$	5 600 pF
All other measurements	100 $\Omega$	56 000 pF

**PACKAGING INFORMATION**

Orderable Device	Status (1)	Package Type	Package Drawing	Pins	Package Qty	Eco Plan (2)	Lead finish/ Ball material (6)	MSL Peak Temp (3)	Op Temp (°C)	Device Marking (4/5)	Samples
TPA3002D2PHP	ACTIVE	HTQFP	PHP	48	250	RoHS & Green	NIPDAU	Level-4-260C-72 HR	-40 to 85	TPA3002D2	<a href="#">Samples</a>
TPA3002D2PHPR	ACTIVE	HTQFP	PHP	48	1000	RoHS & Green	NIPDAU	Level-4-260C-72 HR	-40 to 85	TPA3002D2	<a href="#">Samples</a>

(1) The marketing status values are defined as follows:

**ACTIVE:** Product device recommended for new designs.

**LIFEBUY:** TI has announced that the device will be discontinued, and a lifetime-buy period is in effect.

**NRND:** Not recommended for new designs. Device is in production to support existing customers, but TI does not recommend using this part in a new design.

**PREVIEW:** Device has been announced but is not in production. Samples may or may not be available.

**OBSOLETE:** TI has discontinued the production of the device.

(2) **RoHS:** TI defines "RoHS" to mean semiconductor products that are compliant with the current EU RoHS requirements for all 10 RoHS substances, including the requirement that RoHS substance do not exceed 0.1% by weight in homogeneous materials. Where designed to be soldered at high temperatures, "RoHS" products are suitable for use in specified lead-free processes. TI may reference these types of products as "Pb-Free".

**RoHS Exempt:** TI defines "RoHS Exempt" to mean products that contain lead but are compliant with EU RoHS pursuant to a specific EU RoHS exemption.

**Green:** TI defines "Green" to mean the content of Chlorine (Cl) and Bromine (Br) based flame retardants meet JS709B low halogen requirements of <=1000ppm threshold. Antimony trioxide based flame retardants must also meet the <=1000ppm threshold requirement.

(3) MSL, Peak Temp. - The Moisture Sensitivity Level rating according to the JEDEC industry standard classifications, and peak solder temperature.

(4) There may be additional marking, which relates to the logo, the lot trace code information, or the environmental category on the device.

(5) Multiple Device Markings will be inside parentheses. Only one Device Marking contained in parentheses and separated by a "~" will appear on a device. If a line is indented then it is a continuation of the previous line and the two combined represent the entire Device Marking for that device.

(6) Lead finish/Ball material - Orderable Devices may have multiple material finish options. Finish options are separated by a vertical ruled line. Lead finish/Ball material values may wrap to two lines if the finish value exceeds the maximum column width.

**Important Information and Disclaimer:**The information provided on this page represents TI's knowledge and belief as of the date that it is provided. TI bases its knowledge and belief on information provided by third parties, and makes no representation or warranty as to the accuracy of such information. Efforts are underway to better integrate information from third parties. TI has taken and continues to take reasonable steps to provide representative and accurate information but may not have conducted destructive testing or chemical analysis on incoming materials and chemicals. TI and TI suppliers consider certain information to be proprietary, and thus CAS numbers and other limited information may not be available for release.

In no event shall TI's liability arising out of such information exceed the total purchase price of the TI part(s) at issue in this document sold by TI to Customer on an annual basis.



**TRAY**



Chamfer on Tray corner indicates Pin 1 orientation of packed units.

\*All dimensions are nominal

Device	Package Name	Package Type	Pins	SPQ	Unit array matrix	Max temperature (°C)	L (mm)	W (mm)	K0 (µm)	P1 (mm)	CL (mm)	CW (mm)
TPA3002D2PHP	PHP	HTQFP	48	250	10 x 25	150	315	135.9	7620	12.2	11.1	11.25

## GENERIC PACKAGE VIEW

**PHP 48**

**TQFP - 1.2 mm max height**

7 x 7, 0.5 mm pitch

QUAD FLATPACK

This image is a representation of the package family, actual package may vary.  
Refer to the product data sheet for package details.

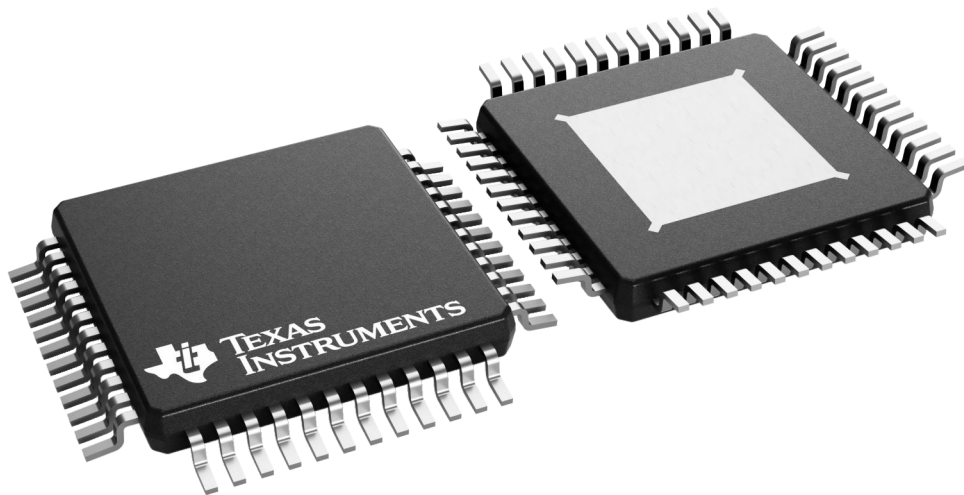

4226443/A

PHP (S-PQFP-G48)

PowerPAD™ PLASTIC QUAD FLATPACK

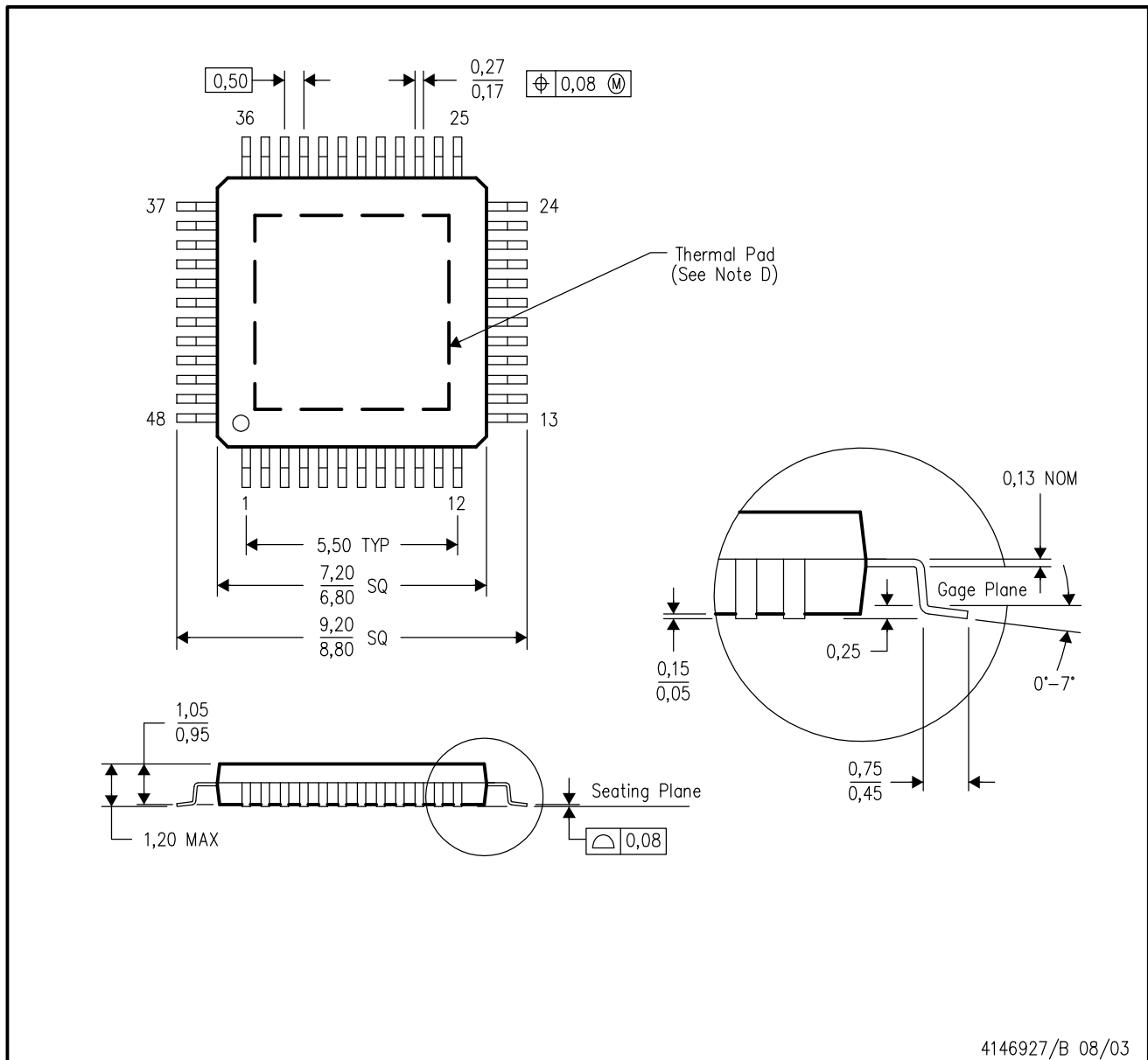

- NOTES:
- A. All linear dimensions are in millimeters.
  - B. This drawing is subject to change without notice.
  - C. Body dimensions do not include mold flash or protrusion
  - D. This package is designed to be soldered to a thermal pad on the board. Refer to Technical Brief, PowerPad Thermally Enhanced Package, Texas Instruments Literature No. SLMA002 for information regarding recommended board layout. This document is available at [www.ti.com](http://www.ti.com) <<http://www.ti.com>>.
  - E. Falls within JEDEC MS-026

PowerPAD is a trademark of Texas Instruments.

# THERMAL PAD MECHANICAL DATA

PHP (S-PQFP-G48)

PowerPAD™ PLASTIC QUAD FLATPACK

## THERMAL INFORMATION

This PowerPAD™ package incorporates an exposed thermal pad that is designed to be attached to a printed circuit board (PCB). The thermal pad must be soldered directly to the PCB. After soldering, the PCB can be used as a heatsink. In addition, through the use of thermal vias, the thermal pad can be attached directly to the appropriate copper plane shown in the electrical schematic for the device, or alternatively, can be attached to a special heatsink structure designed into the PCB. This design optimizes the heat transfer from the integrated circuit (IC).

For additional information on the PowerPAD package and how to take advantage of its heat dissipating abilities, refer to Technical Brief, PowerPAD Thermally Enhanced Package, Texas Instruments Literature No. SLMA002 and Application Brief, PowerPAD Made Easy, Texas Instruments Literature No. SLMA004. Both documents are available at [www.ti.com](http://www.ti.com).

The exposed thermal pad dimensions for this package are shown in the following illustration.

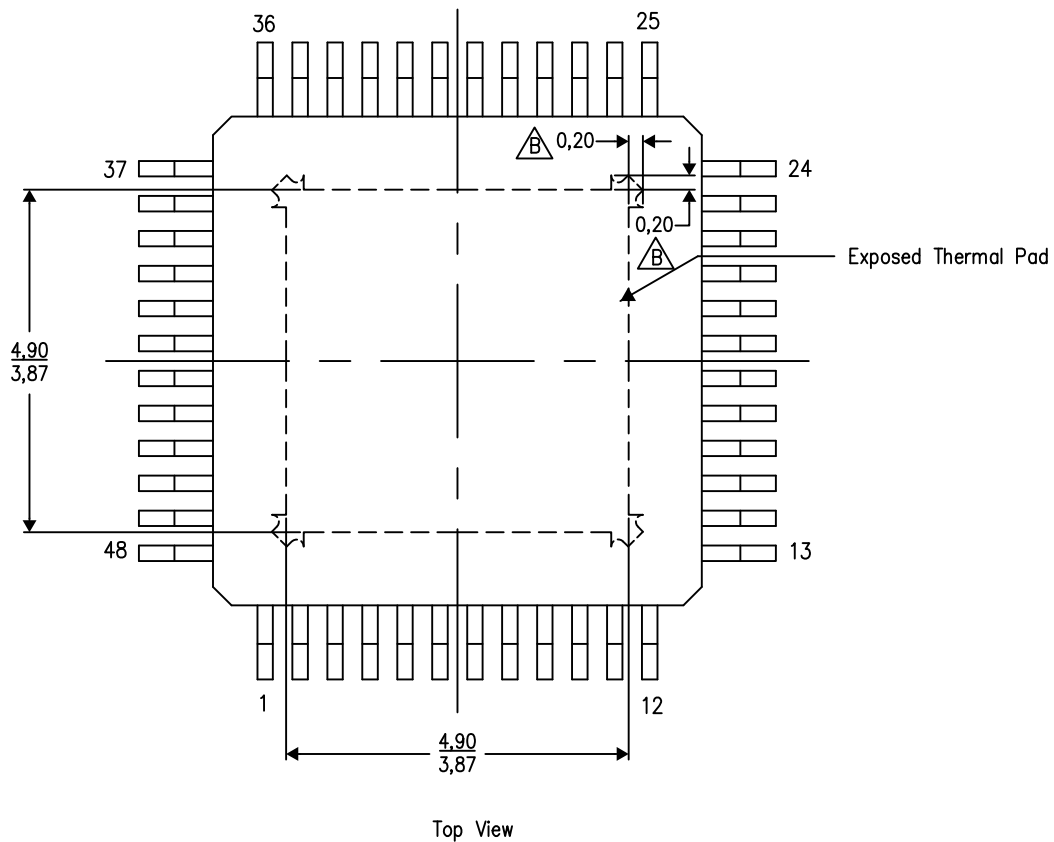

Exposed Thermal Pad Dimensions

4206329-4/P 03/15

NOTE: A. All linear dimensions are in millimeters

 Tie strap features may not be present.

PowerPAD is a trademark of Texas Instruments

PHP (S-PQFP-G48)

PowerPAD™ PLASTIC QUAD FLATPACK

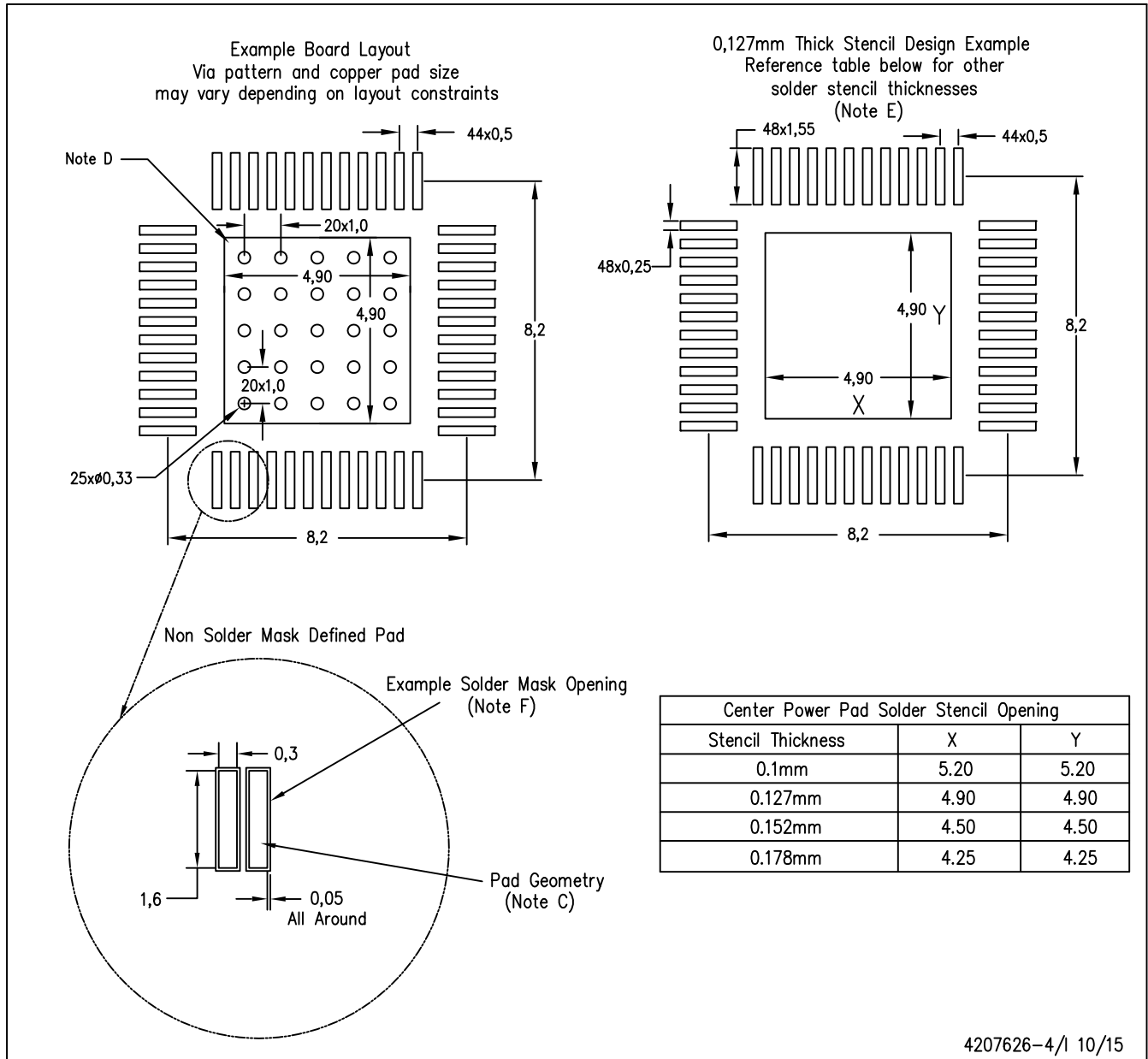

4207626-4/1 10/15

- NOTES:
- A. All linear dimensions are in millimeters.
  - B. This drawing is subject to change without notice.
  - C. Publication IPC-7351 is recommended for alternate designs.
  - D. This package is designed to be soldered to a thermal pad on the board. Refer to Technical Brief, PowerPAD Thermally Enhanced Package, Texas Instruments Literature No. SLMA002, SLMA004, and also the Product Data Sheets for specific thermal information, via requirements, and recommended board layout. These documents are available at [www.ti.com](http://www.ti.com) <<http://www.ti.com>>.
  - E. Laser cutting apertures with trapezoidal walls and also rounding corners will offer better paste release. Customers should contact their board assembly site for stencil design recommendations. Refer to IPC 7525 for stencil design considerations.
  - F. Customers should contact their board fabrication site for recommended solder mask tolerances and via tenting options for vias placed in the thermal pad.

PowerPAD is a trademark of Texas Instruments



## IMPORTANT NOTICE AND DISCLAIMER

TI PROVIDES TECHNICAL AND RELIABILITY DATA (INCLUDING DATA SHEETS), DESIGN RESOURCES (INCLUDING REFERENCE DESIGNS), APPLICATION OR OTHER DESIGN ADVICE, WEB TOOLS, SAFETY INFORMATION, AND OTHER RESOURCES "AS IS" AND WITH ALL FAULTS, AND DISCLAIMS ALL WARRANTIES, EXPRESS AND IMPLIED, INCLUDING WITHOUT LIMITATION ANY IMPLIED WARRANTIES OF MERCHANTABILITY, FITNESS FOR A PARTICULAR PURPOSE OR NON-INFRINGEMENT OF THIRD PARTY INTELLECTUAL PROPERTY RIGHTS.

These resources are intended for skilled developers designing with TI products. You are solely responsible for (1) selecting the appropriate TI products for your application, (2) designing, validating and testing your application, and (3) ensuring your application meets applicable standards, and any other safety, security, regulatory or other requirements.

These resources are subject to change without notice. TI grants you permission to use these resources only for development of an application that uses the TI products described in the resource. Other reproduction and display of these resources is prohibited. No license is granted to any other TI intellectual property right or to any third party intellectual property right. TI disclaims responsibility for, and you will fully indemnify TI and its representatives against, any claims, damages, costs, losses, and liabilities arising out of your use of these resources.

TI's products are provided subject to [TI's Terms of Sale](#) or other applicable terms available either on [ti.com](http://ti.com) or provided in conjunction with such TI products. TI's provision of these resources does not expand or otherwise alter TI's applicable warranties or warranty disclaimers for TI products.

TI objects to and rejects any additional or different terms you may have proposed.

Mailing Address: Texas Instruments, Post Office Box 655303, Dallas, Texas 75265  
Copyright © 2022, Texas Instruments Incorporated