

# TPD3S713-Q1 具有可调电流限值和 $V_{BATT}$ 短路保护功能的汽车类 USB 2.0 接口保护器件

## 1 特性

- 符合面向汽车应用的 AEC-Q100 标准：
  - 器件温度等级 1：-40°C 至 +125°C 环境温度工作温度范围
  - 器件 HBM ESD 分类等级 H2
  - 器件 CDM ESD 分类等级 C5
- $V_{BUS}$  引脚上的电池短路保护 (高达 18V) 和接地短路保护功能
- DM\_IN、DP\_IN 引脚上的电池短路保护 (高达 18V) 和  $V_{BUS}$  短路保护功能
- 符合 IEC 61000-4-2 标准的 DP\_IN、DM\_IN 和  $V_{BUS}$ 
  - $\pm 8kV$  接触放电和  $\pm 15kV$  空气放电
- 符合 ISO 10605 (330pF, 330 $\Omega$ ) 标准的 DP\_IN、DM\_IN 和  $V_{BUS}$ 
  - $\pm 8kV$  接触放电和  $\pm 15kV$  空气放电
- 高速数据开关 (1230MHz 带宽)
- 4.5V 至 5.5V 输入电压工作范围
- 50mA 至 600mA 可调节电流限值 (200mA 时精度为  $\pm 13.5\%$ )
- 集成 73m $\Omega$  (典型值) 高侧 MOSFET
- 500mA 最大连续输出电流
- $V_{BUS}$  电缆补偿
- 20 引脚 QFN (3mm  $\times$  4mm) 封装

## 2 应用

- 汽车 USB 接口
  - 音响主机
  - 远程信息处理
  - 导航模块
- 汽车 USB 充电端口
  - 媒体接口

## 3 说明

TPD3S713-Q1 是一款单芯片解决方案，在汽车 USB 集线器、音响主机、远程信息处理和媒体接口应用中为高速数据和电力线提供电池短路、短路和 ESD 保护。集成的数据开关提供了同类最佳的带宽，能够在 USB 发生电池短路时最大限度地减少信号衰减。高达 1.2GHz 的带宽可利用汽车 USB 环境中常见的长系留线缆来实现干净的 USB2.0 高速 (480Mbps) 眼图。

电池短路保护可隔离内部系统电路，防止其受到  $V_{BUS}$ 、DP\_IN 和 DM\_IN 引脚上任何过压情况的影响。在这些引脚上，TPD3S713-Q1 可处理发生热插拔和直流事件时高达 18V 的过压，并关闭内部开关，保护上游收发器免受有害电压和电流尖峰的影响。

$V_{BUS}$  引脚还提供灵活的可调节限流负载开关 (从 50mA 到 600mA)，如果端口只需要数十毫安的电流，可节省系统功率预算。

TPD3S713-Q1 器件具有一个能够控制上行电源的电流检测输出，因此可在连接长 USB 电缆的远程 USB 端口处保持 5V 的电压。

### 器件信息(1)

器件型号	封装	封装尺寸 (标称值)
TPD3S713-Q1	WQFN (20)	4.00mm $\times$ 3.00mm

- (1) 如需了解所有可用封装，请参阅数据表末尾的可订购产品附录。

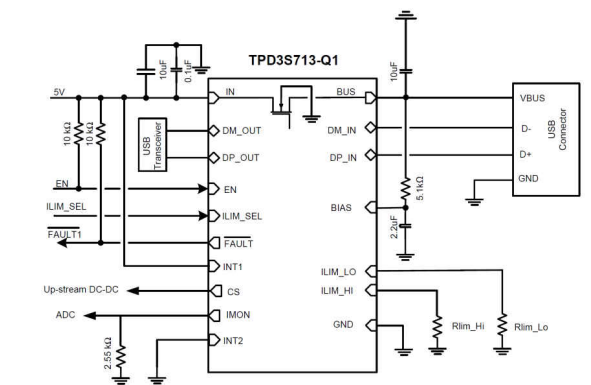

原理图



## Table of Contents

<b>1 特性</b> .....	<b>1</b>	8.4 Device Functional Modes.....	<b>21</b>
<b>2 应用</b> .....	<b>1</b>	<b>9 Application and Implementation</b> .....	<b>23</b>
<b>3 说明</b> .....	<b>1</b>	9.1 Application Information.....	23
<b>4 Revision History</b> .....	<b>2</b>	9.2 Typical Application.....	23
<b>5 Pin Configuration and Functions</b> .....	<b>3</b>	<b>10 Power Supply Recommendations</b> .....	<b>27</b>
<b>6 Specifications</b> .....	<b>4</b>	<b>11 Layout</b> .....	<b>27</b>
6.1 Absolute Maximum Ratings.....	4	11.1 Layout Guidelines.....	27
6.2 ESD Ratings.....	4	11.2 Layout Example.....	29
6.3 Recommended Operating Conditions.....	4	<b>12 Device and Documentation Support</b> .....	<b>30</b>
6.4 Thermal Information.....	5	12.1 Documentation Support.....	30
6.5 Electrical Characteristics.....	5	12.2 接收文档更新通知.....	30
6.6 Switching Characteristics.....	8	12.3 支持资源.....	30
6.7 Typical Characteristics.....	9	12.4 Trademarks.....	30
<b>7 Parameter Measurement Information</b> .....	<b>14</b>	12.5 Electrostatic Discharge Caution.....	30
<b>8 Detailed Description</b> .....	<b>15</b>	12.6 术语表.....	30
8.1 Overview.....	15	<b>13 Mechanical, Packaging, and Orderable Information</b> .....	<b>30</b>
8.2 Functional Block Diagram.....	16		
8.3 Feature Description.....	16		

## 4 Revision History

Changes from Revision * (May 2020) to Revision A (February 2022)	Page
• 更新了整个文档中的表格、图和交叉参考的编号格式.....	1
• 为 ESD 等级增加了 ISO 10605 ( 330pF , 330 Ω ) .....	1

## 5 Pin Configuration and Functions

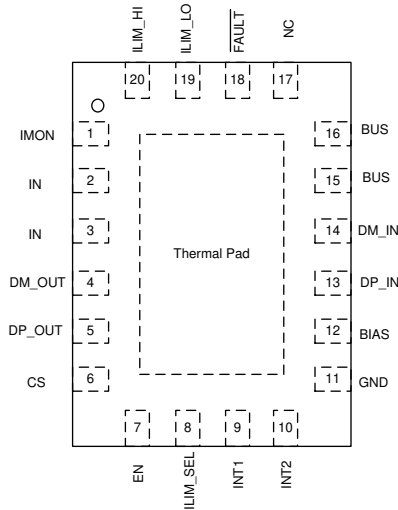

**图 5-1. RVC Package 20-Pin WQFN Top View**

**表 5-1. Pin Functions**

PIN		TYPE <sup>(1)</sup>	DESCRIPTION
NAME	NO.		
IMON	1	O	This pin sources a scaled-down ratio of current through the internal FET. A resistor from this pin to GND converts current to proportional voltage; used as an analog current monitor.
IN	2,3	PWR	Input supply voltage; connect a 0.1- $\mu$ F or greater ceramic capacitor from IN to GND as close to the IC as possible.
DM_OUT	4	I/O	DM data line to upstream USB host controller
DP_OUT	5	I/O	DP data line to upstream USB host controller
CS	6	O	Linear cable compensation current. Connect to divider resistor of front-end dc-dc converter.
EN	7	I	Logic-level control input for turning the power and signal switches on or off. When EN is low, the device is disabled, and the signal and power switches are OFF.
ILIM_SEL	8	I	Logic-level control input for choosing the current limit resistor and current limit threshold. When ILIM_SEL = High, ILIM_HI resistor is valid; When ILIM_SEL = Low, ILIM_LO resistor is valid.
INT1	9	I	Logic-level control input, the device can be set in normal mode or client mode through pin configuration. If INT1 = high, the device is in normal mode; If INT1 = low and ILIM_SEL = Low, the device is in client mode.
INT2	10	I	For internal circuit, must connect to ground without a pull down resistor.
GND	11	—	Ground connection; must be connected externally to the thermal pad.
BIAS	12	PWR	Used for IEC protection. Typically, connect a 2.2- $\mu$ F capacitor to ground and 5.1-k $\Omega$ resistor to BUS.
DP_IN	13	I/O	DP data line to downstream connector
DM_IN	14	I/O	DM data line to downstream connector
BUS	15,16	PWR	Power-switch output
NC	17	NC	No connect, leave floating or connect to ground.
FAULT	18	O	Active-low, open-drain output, asserted during overtemperature, overcurrent, and overvoltage conditions.
ILIM_LO	19	I	External resistor used to set the low current-limit threshold, selected by ILIM_SEL pin.
ILIM_HI	20	I	External resistor used to set the high current-limit threshold, selected by ILIM_SEL pin.
Thermal pad		—	Thermal pad on the bottom of the package

(1) I = Input, O = Output, I/O = Input and output, PWR = Power

## 6 Specifications

### 6.1 Absolute Maximum Ratings

Voltages are with respect to GND unless otherwise noted<sup>(1)</sup>

		MIN	MAX	UNIT
Voltage range	CS, ILIM_SEL, INT1, EN, FAULT, ILIM_HI, ILIM_LO, IN, IMON, INT2	- 0.3	7	V
	DM_OUT, DP_OUT	- 0.3	5.7	
	BIAS, DM_IN, DP_IN, VBUS	- 0.3	18	
Continuous current	DM_IN to DM_OUT or DP_IN to DP_OUT	- 100	100	mA
	IBUS	Internally limited		
Continuous output source current, I <sub>SRC</sub>	ILIM_HI, LIM_LO, IMON	Internally limited		A
Continuous output sink current, I <sub>SNK</sub>	FAULT	25		mA
	CS	Internally limited		
Operating junction temperature, T <sub>J</sub>		- 40	150	°C
Storage temperature, T <sub>stg</sub>		- 65	150	°C

- (1) Stresses beyond those listed under *Absolute Maximum Ratings* may cause permanent damage to the device. These are stress ratings only, which do not imply functional operation of the device at these or any other conditions beyond those indicated under *Recommended Operating Conditions*. Exposure to absolute-maximum-rated conditions for extended periods may affect device reliability.

### 6.2 ESD Ratings

		VALUE	UNIT	
V <sub>(ESD)</sub>	Electrostatic discharge			
	Human-body model (HBM), per AEC Q100-002 <sup>(1)</sup>	±2000 <sup>(2)</sup>	V	
	Charged-device model (CDM), per AEC Q100-011	±750 <sup>(3)</sup>		
	IEC 61000-4-2 contact discharge	DP_IN, DM_IN and V <sub>BUS</sub> pins <sup>(4)</sup>		±8000
	IEC 61000-4-2 air discharge	DP_IN, DM_IN and V <sub>BUS</sub> pins <sup>(4)</sup>		±15000
	ISO 10605 (330 pF, 330 Ω), contact discharge	DP_IN, DM_IN and V <sub>BUS</sub> pins <sup>(5)</sup>		±8000
ISO 10605 (330 pF, 330 Ω), air discharge	DP_IN, DM_IN and V <sub>BUS</sub> pins <sup>(5)</sup>	±15000		

- (1) AEC Q100-002 indicates that HBM stressing shall be in accordance with the ANSI/ESDA/JEDEC JS-001 specification.  
 (2) The passing level per AEC-Q100 Classification H2.  
 (3) The passing level per AEC-Q100 Classification C5.  
 (4) Surges per IEC 61000-4-2, level 4, 1999 applied from DP\_IN, DM\_IN and V<sub>BUS</sub> to output ground of the TPD3S713Q1EVM-103 evaluation module.  
 (5) Surges per ISO 10605 (330 pF, 330 Ω), applied from DP\_IN, DM\_IN and V<sub>BUS</sub> to output ground of the TPD3S713Q1EVM-103 evaluation module.

### 6.3 Recommended Operating Conditions

Voltages are with respect to GND unless otherwise noted.

		MIN	NOM	MAX	UNIT
V <sub>(IN)</sub>	Supply voltage	IN	4.5	5.5	V
	Input voltage	EN, ILIM_SEL, INT1, INT2	0	5.5	V
I <sub>(BUS)</sub>	Output continuous current	DM_IN, DM_OUT, DP_IN, DP_OUT	0	3.6	V
		IBUS		500	mA
	Continuous output sink current	DM_IN to DM_OUT or DP_IN to DP_OUT	- 30	30	mA
	Continuous output sink current	FAULT		10	mA
R <sub>(ILIM_xx)</sub>	Current-limit-set resistors		6.98	100	kΩ
T <sub>J</sub>	Operating junction temperature		- 40	125	°C

## 6.4 Thermal Information

THERMAL METRIC <sup>(1)</sup>		TPD3S713-Q1	UNIT
		RVC (WQFN)	
		20 PINS	
$R_{\theta JA}$	Junction-to-ambient thermal resistance	37.9	°C/W
$R_{\theta JC(top)}$	Junction-to-case (top) thermal resistance	39.9	°C/W
$R_{\theta JB}$	Junction-to-board thermal resistance	11.9	°C/W
$\psi_{JT}$	Junction-to-top characterization parameter	0.5	°C/W
$\psi_{JB}$	Junction-to-board characterization parameter	11.8	°C/W
$R_{\theta JC(bot)}$	Junction-to-case (bottom) thermal resistance	3.2	°C/W

(1) For more information about traditional and new thermal metrics, see the [Semiconductor and IC Package Thermal Metrics](#) application report.

## 6.5 Electrical Characteristics

Unless otherwise noted,  $-40^{\circ}\text{C} \leq T_J \leq 125^{\circ}\text{C}$  and  $4.5\text{ V} \leq V_{(IN)} \leq 5.5\text{ V}$ ,  $V_{(EN)} = V_{(INT1)} = V_{(ILIM\_SEL)} = V_{(IN)}$ ,  $V_{(INT2)} = \text{GND}$ ,  $R_{(FAULT)} = 10\text{ k}\Omega$ ,  $R_{(IMON)} = 2.55\text{ k}\Omega$ ,  $R_{(ILIM\_HI)} = 52.3\text{ k}\Omega$ . Positive currents are into pins. Typical values are at  $T_J = 25^{\circ}\text{C}$ . All voltages are with respect to GND.

PARAMETER	TEST CONDITIONS	MIN	TYP	MAX	UNIT	
OUT - POWER SWITCH						
$r_{DS(on)}$	On-resistance <sup>(1)</sup>	$T_J = 25^{\circ}\text{C}$	73	90	m $\Omega$	
		$-40^{\circ}\text{C} \leq T_J \leq 125^{\circ}\text{C}$	73	120		
$I_{lkg}$	Reverse leakage current	$V_{BUS} = 5\text{ V}$ , $V_{IN} = V_{EN} = 0\text{ V}$ , $-40^{\circ}\text{C} \leq T_J \leq 125^{\circ}\text{C}$ , measure $I_{(IN)}$		0.01	2	$\mu\text{A}$
OUT - DISCHARGE						
$R_{(DCHG)}$	Discharge resistance (ILIM_SEL change)	400	500	630	$\Omega$	
ENABLE, ILIM_SEL, INT1, INT2 INPUTS						
	Input pin rising logic threshold voltage	0.8	1.35	2	V	
	Input pin falling logic threshold voltage	0.7	1.15	1.65	V	
	Hysteresis <sup>(2)</sup>		200		mV	
	Input current	Pin voltage = 0 V or 5.5 V		-1	1	$\mu\text{A}$
CURRENT LIMIT						
$I_{OS}$	VBUS short-circuit current limit	$R_{ILIM\_HI}$ or $R_{ILIM\_LO} = 80.6\text{ k}\Omega$	38	55	71	mA
		$R_{ILIM\_HI}$ or $R_{ILIM\_LO} = 52.3\text{ k}\Omega$	62	82	102	
		$R_{ILIM\_HI}$ or $R_{ILIM\_LO} = 22.1\text{ k}\Omega$	166	192	218	
		$R_{ILIM\_HI}$ or $R_{ILIM\_LO} = 15.4\text{ k}\Omega$	245	275	305	
		$R_{ILIM\_HI}$ or $R_{ILIM\_LO} = 6.98\text{ k}\Omega$	560	600	640	
		$R_{ILIM\_HI}$ Shorted to GND	860	1150	1440	
$R_{ILIM\_HI}$ Shorted to GND						
$I_{(IN\_OFF)}$	Disabled IN supply current	$V_{(EN)} = 0\text{ V}$ , $V_{(BUS)} = 0\text{ V}$ , $-40^{\circ}\text{C} \leq T_J \leq 125^{\circ}\text{C}$ , no 5.1-k $\Omega$ resistor (open) between BIAS and VBUS		0.1	10	$\mu\text{A}$
$I_{(IN\_ON)}$	Enabled IN supply current	$V_{(INT1)} = V_{(ILIM\_SEL)} = \text{High}$		200	280	$\mu\text{A}$

### 6.5 Electrical Characteristics (continued)

Unless otherwise noted,  $-40^{\circ}\text{C} \leq T_J \leq 125^{\circ}\text{C}$  and  $4.5\text{ V} \leq V_{(\text{IN})} \leq 5.5\text{ V}$ ,  $V_{(\text{EN})} = V_{(\text{INT}1)} = V_{(\text{ILIM\_SEL})} = V_{(\text{IN})}$ ,  $V_{(\text{INT}2)} = \text{GND}$ ,  $R_{(\text{FAULT})} = 10\text{ k}\Omega$ ,  $R_{(\text{IMON})} = 2.55\text{ k}\Omega$ ,  $R_{(\text{ILIM\_HI})} = 52.3\text{ k}\Omega$ . Positive currents are into pins. Typical values are at  $T_J = 25^{\circ}\text{C}$ . All voltages are with respect to GND.

PARAMETER		TEST CONDITIONS	MIN	TYP	MAX	UNIT
UNDERVOLTAGE LOCKOUT, IN						
V <sub>(UVLO)</sub>	UVLO threshold voltage	IN rising	3.9	4.1	4.3	V
		IN falling	3.3	3.5	3.7	
FAULT						
	Output low voltage	I <sub>(FAULT)</sub> = 1 mA			100	mV
	Off-state leakage	V <sub>(FAULT)</sub> = 5.5 V			2	μA
THERMAL SHUTDOWN						
T <sub>(OTSD2)</sub>	Thermal shutdown threshold		155			°C
T <sub>(OTSD1)</sub>	Thermal shutdown threshold in current-limit		135			°C
	Hysteresis <sup>(3)</sup>			20		°C
DM_IN AND DP_IN OVERVOLTAGE PROTECTION						
V <sub>(OV_Data)</sub>	Protection trip threshold	DP_IN and DM_IN rising	3.3	3.9	4.15	V
	Hysteresis <sup>(3)</sup>			100		mV
R <sub>(DCHG_Data)</sub>	Discharge resistor after OVP <sup>(3)</sup>	DP_IN = DM_IN = 18 V, IN = 5 V or 0 V		200		kΩ
		DP_IN = DM_IN = 5 V, IN = 5 V		370		
		DP_IN = DM_IN = 5 V, IN = 0		390		
BUS OVERVOLTAGE PROTECTION						
V <sub>(OV_BUS)</sub>	Protection trip threshold	VBUS rising	5.65	6	6.35	V
	Hysteresis <sup>(3)</sup>			90		mV
R <sub>(DCHG_BUS)</sub>	Discharge resistor	VBUS = 18 V, IN = 5 V		55	85	kΩ
		VBUS = 18 V, IN = 0		80	120	
CABLE COMPENSATION						
I <sub>(CS)</sub>	Sink current	Load = 0.5 A, 2.5 V ≤ V <sub>(CS)</sub> ≤ 5.5 V	190	210	230	μA

## 6.5 Electrical Characteristics (continued)

Unless otherwise noted,  $-40^{\circ}\text{C} \leq T_J \leq 125^{\circ}\text{C}$  and  $4.5\text{ V} \leq V_{(IN)} \leq 5.5\text{ V}$ ,  $V_{(EN)} = V_{(INT1)} = V_{(ILIM\_SEL)} = V_{(IN)}$ ,  $V_{(INT2)} = \text{GND}$ ,  $R_{(FAULT)} = 10\text{ k}\Omega$ ,  $R_{(IMON)} = 2.55\text{ k}\Omega$ ,  $R_{(ILIM\_HI)} = 52.3\text{ k}\Omega$ . Positive currents are into pins. Typical values are at  $T_J = 25^{\circ}\text{C}$ . All voltages are with respect to GND.

PARAMETER		TEST CONDITIONS	MIN	TYP	MAX	UNIT
CURRENT MONITOR OUTPUT (IMON)						
$I_{(IMON)}$	Source current	Load = 0.5 A, $0 \leq V_{(IMON)} \leq 2.5\text{ V}$	245	265	285	$\mu\text{A}$
HIGH-BANDWIDTH ANALOG SWITCH						
$R_{(HS\_ON)}$	DP and DM switch on-resistance	$V_{(DP\_OUT)} = V_{(DM\_OUT)} = 0\text{ V}$ , $I_{(DP\_IN)} = I_{(DM\_IN)} = 30\text{ mA}$		3.2	6.5	$\Omega$
		$V_{(DP\_OUT)} = V_{(DM\_OUT)} = 2.4\text{ V}$ , $I_{(DP\_IN)} = I_{(DM\_IN)} = -15\text{ mA}$		3.8	7.6	
$ \Delta R_{(HS\_ON)} $	Switch resistance mismatch between DP and DM channels	$V_{(DP\_OUT)} = V_{(DM\_OUT)} = 0\text{ V}$ , $I_{(DP\_IN)} = I_{(DM\_IN)} = 30\text{ mA}$		0.05	0.15	$\Omega$
		$V_{(DP\_OUT)} = V_{(DM\_OUT)} = 2.4\text{ V}$ , $I_{(DP\_IN)} = I_{(DM\_IN)} = -15\text{ mA}$		0.05	0.15	
$C_{(IO\_OFF)}$	DP and DM switch off-state capacitance <sup>(4)</sup>	$V_{EN} = 0\text{ V}$ , $V_{(DP\_IN)} = V_{(DM\_IN)} = 0.3\text{ V}$ , $V_{ac} = 0.03\text{ V}_{PP}$ , $f = 1\text{ MHz}$		8.8		pF
$C_{(IO\_ON)}$	DP and DM switch on-state capacitance <sup>(4)</sup>	$V_{(DP\_IN)} = V_{(DM\_IN)} = 0.3\text{ V}$ , $V_{ac} = 0.03\text{ V}_{PP}$ , $f = 1\text{ MHz}$		10.9		pF
	Off-state isolation <sup>(4)</sup>	$V_{(EN)} = 0\text{ V}$ , $f = 250\text{ MHz}$		12		dB
	On-state cross-channel isolation <sup>(4)</sup>	$f = 250\text{ MHz}$		34		dB
$I_{(kg(OFF))}$	Off-state leakage current	$V_{EN} = 0\text{ V}$ , $V_{(DP\_IN)} = V_{(DM\_IN)} = 3.6\text{ V}$ , $V_{(DP\_OUT)} = V_{(DM\_OUT)} = 0\text{ V}$ , measure $I_{(DP\_OUT)}$ and $I_{(DM\_OUT)}$		0.1	1.5	$\mu\text{A}$
BW	Bandwidth ( - 3 dB) <sup>(4)</sup>	$R_{(L)} = 50\ \Omega$		1230		MHz

- (1) Pulse-testing techniques maintain junction temperature close to ambient temperature. Thermal effects must be taken into account separately.
- (2) This parameter is provided for reference only and does not constitute part of TI's published device specifications for purposes of TI's product warranty.
- (3) This parameter is provided for reference only and does not constitute part of TI's published device specifications for purposes of TI's product warranty.
- (4) This parameter is provided for reference only and does not constitute part of TI's published device specifications for purposes of TI's product warranty.

## 6.6 Switching Characteristics

Unless otherwise noted,  $-40^{\circ}\text{C} \leq T_J \leq 125^{\circ}\text{C}$  and  $4.5\text{ V} \leq V_{(IN)} \leq 5.5\text{ V}$ ,  $V_{(EN)} = V_{(INT1)} = V_{(ILIM\_SEL)} = V_{(IN)}$ ,  $V_{(INT2)} = \text{GND}$ ,  $R_{(FAULT)} = 10\text{ k}\Omega$ ,  $R_{(IMON)} = 2.55\text{ k}\Omega$ ,  $R_{(ILIM\_HI)} = 52.3\text{ k}\Omega$ . Positive currents are into pins. Typical values are at  $T_J = 25^{\circ}\text{C}$ . All voltages are with respect to GND.

PARAMETER		TEST CONDITIONS	MIN	TYP	MAX	UNIT
$t_r$	BUS voltage rise time	$V_{(IN)} = 5\text{ V}$ , $C_{(L)} = 1\ \mu\text{F}$ , $R_{(L)} = 100\ \Omega$	1.05	1.75	3.1	ms
$t_f$	BUS voltage fall time		0.27	0.47	0.82	ms
$t_{on}$	BUS voltage turn-on time	$V_{(IN)} = 5\text{ V}$ , $C_{(L)} = 1\ \mu\text{F}$ , $R_{(L)} = 100\ \Omega$		7.5	11	ms
$t_{off}$	BUS voltage turn-off time			2.7	5	ms
$t_{(DCHG\_S)}$	Discharge hold time (ILIM_SEL change)	Time $V_{(OUT)} < 0.7\text{V}$	1.1	2	2.9	s
$t_{(IOS)}$	BUS short-circuit response time <sup>(1)</sup>	$V_{(IN)} = 5\text{ V}$ , $R_{(SHORT)} = 50\text{ m}\Omega$		2		$\mu\text{s}$
$t_{(OC\_BUS\_FAULT)}$	BUS FAULT deglitch time	Bidirectional deglitch applicable to current-limit condition only (no deglitch assertion for OTSD)	5.5	8.5	11.5	ms
$t_{pd}$	Analog switch propagation delay <sup>(1)</sup>	$V_{(IN)} = 5\text{ V}$		0.14		ns
$t_{(SK)}$	Analog switch skew between opposite transitions of the same port ( $t_{PHL} - t_{PLH}$ ) <sup>(1)</sup>	$V_{(IN)} = 5\text{ V}$		0.02		ns
$t_{(OV\_Data)}$	DP_IN and DM_IN overvoltage protection response time			5		$\mu\text{s}$
$t_{(OV\_BUS)}$	BUS overvoltage protection response time			0.3		$\mu\text{s}$
$t_{(OV\_Data\_FAULT)}$	DP_IN and DM_IN FAULT-asserted deglitch time		11	16	23	ms
	BUS FAULT-asserted deglitch time		11	16	23	ms

- (1) These parameters are provided for reference only and do not constitute part of TI's published device specifications for purposes of TI's product warranty.



## 6.7 Typical Characteristics

$T_A = 25^\circ\text{C}$ ,  $V_{(IN)} = 5\text{ V}$ ,  $V_{(EN)} = V_{(IN)}$ ,  $V_{(ILIM\_SEL)} = V_{(INT1)} = V_{(IN)}$ ,  $V_{(INT2)} = \text{GND}$ ,  $\overline{\text{FAULT}}$  connect to  $V_{(IN)}$  via a 10-k  $\Omega$  pullup resistor (unless stated otherwise)



图 6-1. Power Switch On-Resistance vs Temperature



图 6-2. Reverse Leakage Current vs Temperature

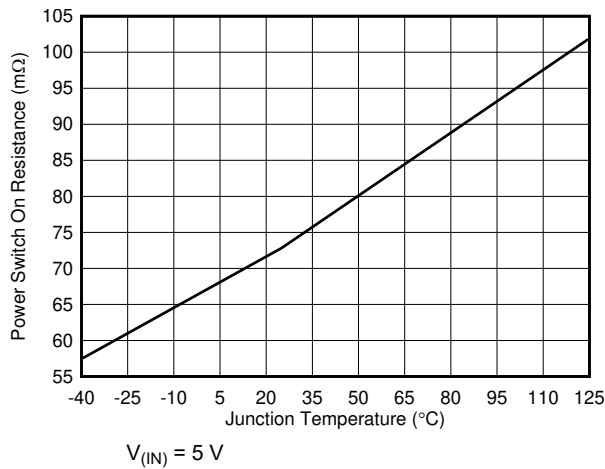

图 6-3. BUS Discharge Resistance (OVP) vs Temperature

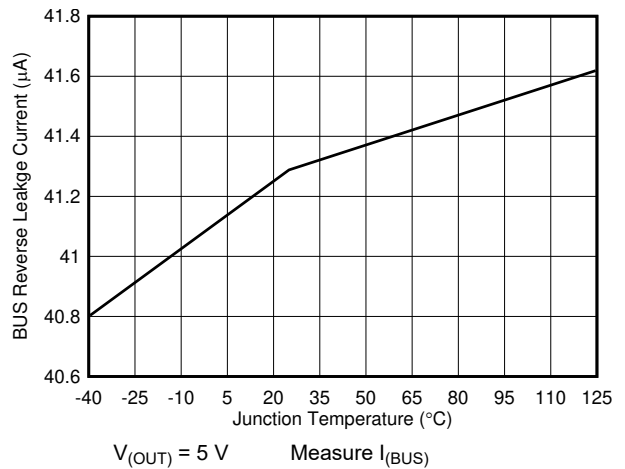

图 6-4. BUS Discharge Resistance (Mode Change) vs Temperature

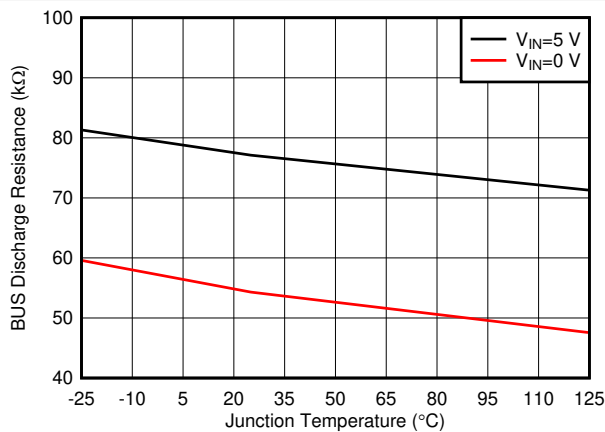

图 6-5. VBUS Short-Circuit Current Limit vs Temperature

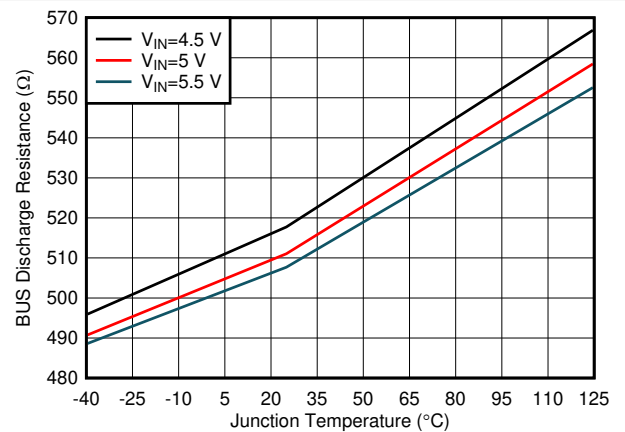

图 6-6. Disabled IN Supply Current vs Temperature

### 6.7 Typical Characteristics (continued)

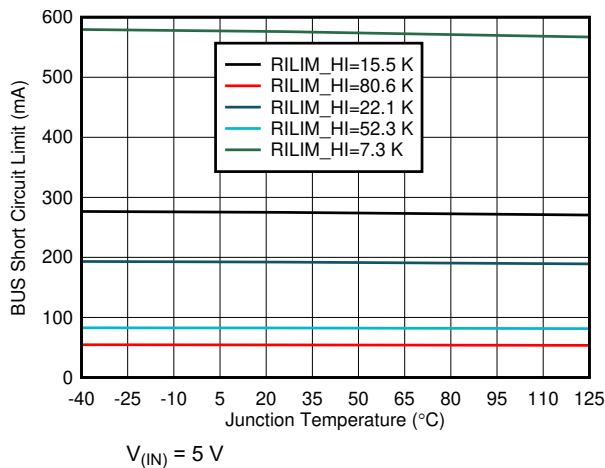
$T_A = 25^\circ\text{C}$ ,  $V_{(IN)} = 5\text{ V}$ ,  $V_{(EN)} = V_{(IN)}$ ,  $V_{(ILIM\_SEL)} = V_{(INT1)} = V_{(IN)}$ ,  $V_{(INT2)} = \text{GND}$ ,  $\overline{\text{FAULT}}$  connect to  $V_{(IN)}$  via a 10-k  $\Omega$  pullup resistor (unless stated otherwise)

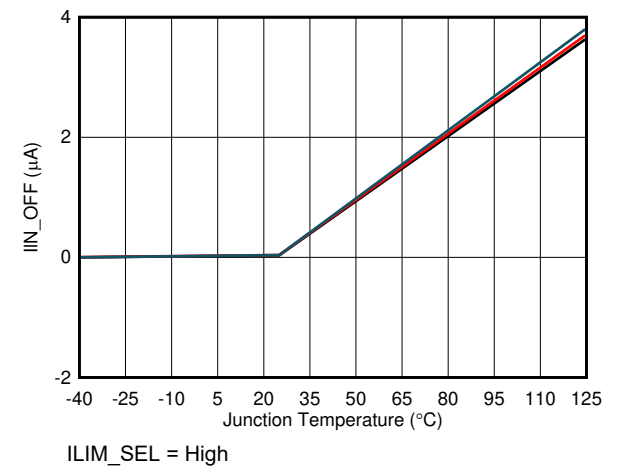
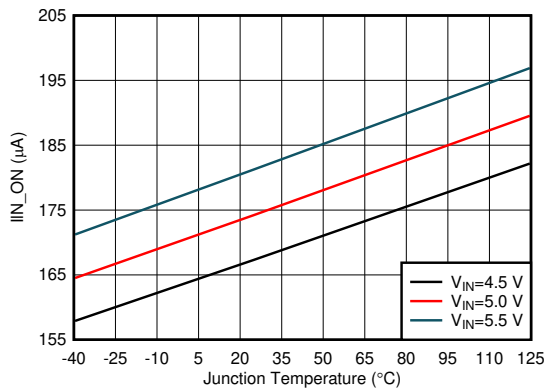

ILIM\_SEL = High

图 6-7. Enabled IN Supply Current vs Temperature

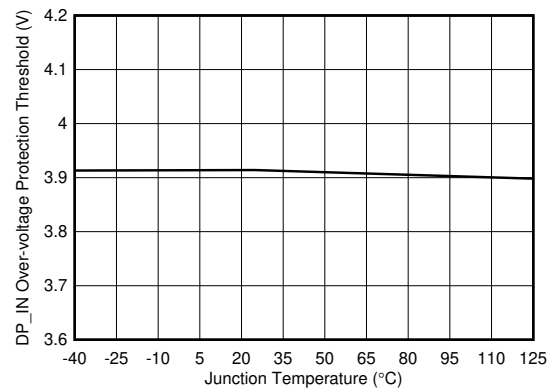

$V_{(IN)} = 5\text{ V}$

图 6-8. DP\_IN Overvoltage Protection Threshold vs Temperature

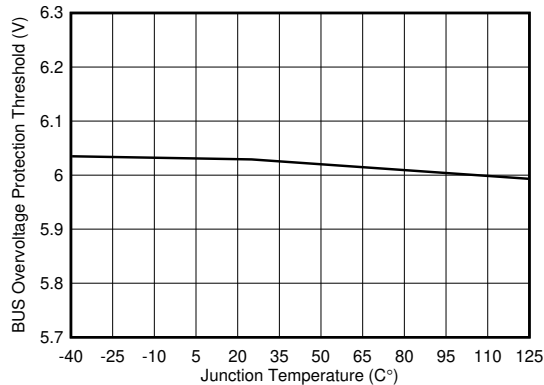

$V_{(IN)} = 5\text{ V}$

图 6-9. BUS Overvoltage Protection Threshold vs Temperature

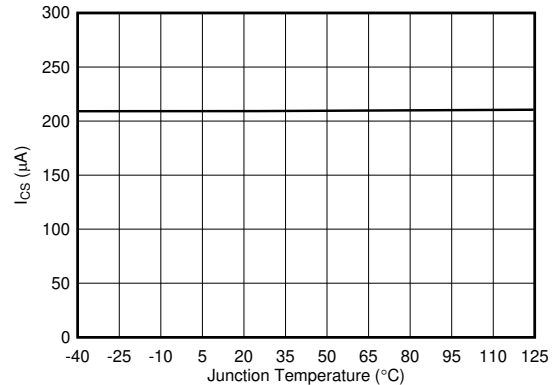

$I_{BUS} = 0.5\text{ A}$        $V_{(CS)} = 2.5\text{ V}$

图 6-10.  $I_{(CS)}$  vs Temperature

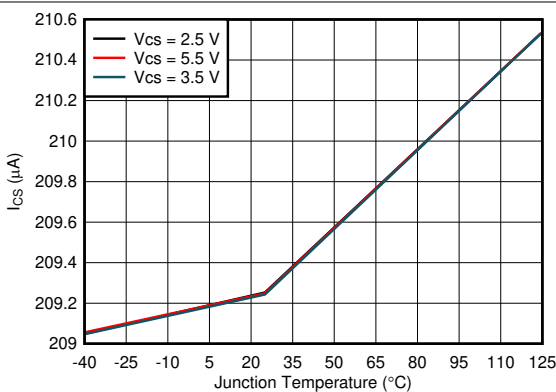

$V_{IN} = 5.5\text{ V}$        $I_{BUS} = 0.5\text{ A}$

图 6-11.  $I_{(CS)}$  vs  $V_{(CS)}$  Voltage

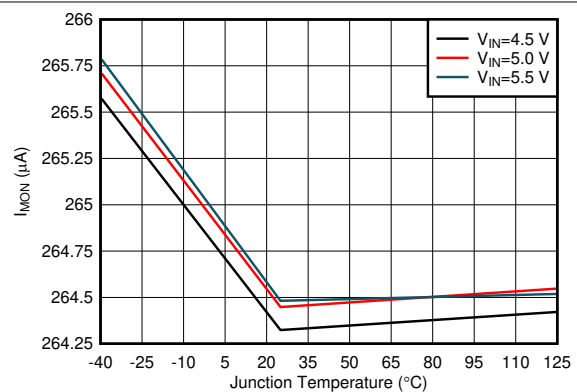

$I_{BUS} = 0.5\text{ A}$        $V_{(IMON)} = 2.5\text{ V}$

图 6-12.  $I_{(IMON)}$  vs Temperature

## 6.7 Typical Characteristics

$T_A = 25^\circ\text{C}$ ,  $V_{(IN)} = 5\text{ V}$ ,  $V_{(EN)} = V_{(IN)}$ ,  $V_{(ILIM\_SEL)} = V_{(INT1)} = V_{(IN)}$ ,  $V_{(INT2)} = \text{GND}$ ,  $\overline{\text{FAULT}}$  connect to  $V_{(IN)}$  via a  $10\text{-k}\Omega$  pullup resistor (unless stated otherwise)



图 6-13.  $I_{(MON)}$  vs  $V_{(CS)}$  Voltage



Measured on EVM with 10-cm cable

图 6-14. Bypassing the TPD3S713-Q1 Data Switch

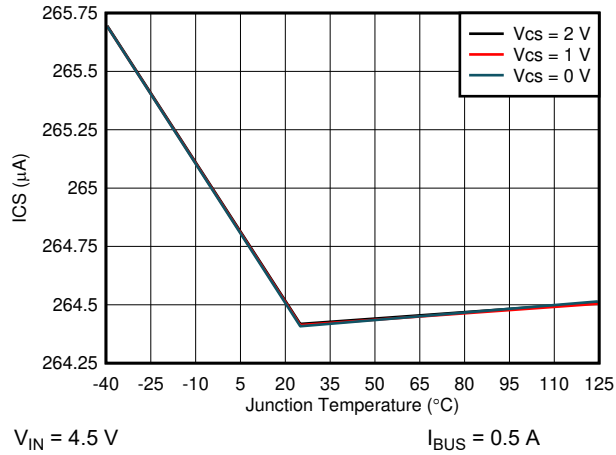
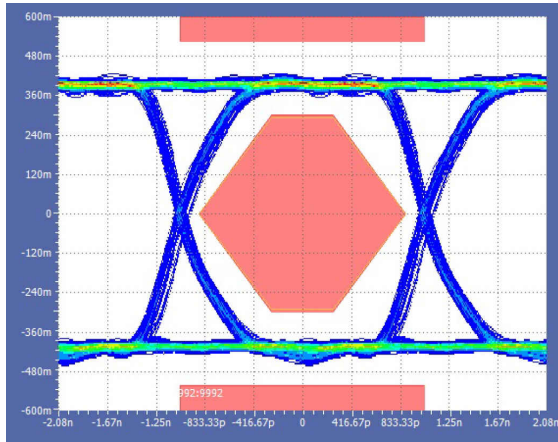
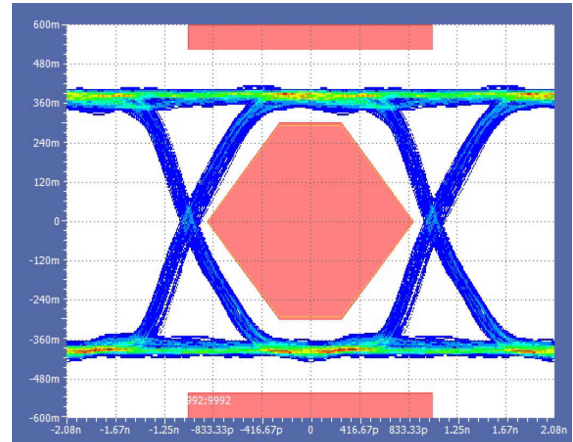

Measured on EVM with 10-cm cable

图 6-15. Through the TPD3S713-Q1 Data Switch



图 6-16. Turn-on Response



图 6-17. Turn-off Response

### 6.7 Typical Characteristics (continued)

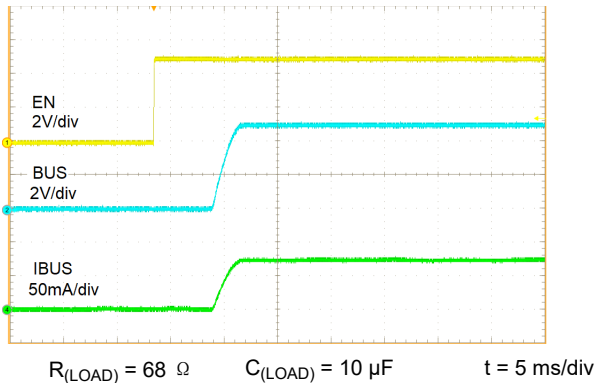
$T_A = 25^\circ\text{C}$ ,  $V_{(IN)} = 5\text{ V}$ ,  $V_{(EN)} = V_{(IN)}$ ,  $V_{(ILIM\_SEL)} = V_{(INT1)} = V_{(IN)}$ ,  $V_{(INT2)} = \text{GND}$ ,  $\overline{\text{FAULT}}$  connect to  $V_{(IN)}$  via a 10-k  $\Omega$  pullup resistor (unless stated otherwise)

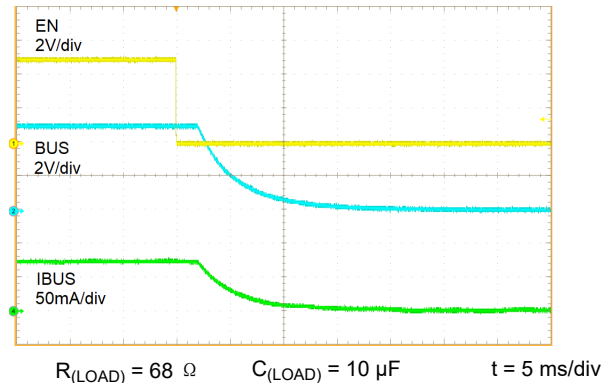
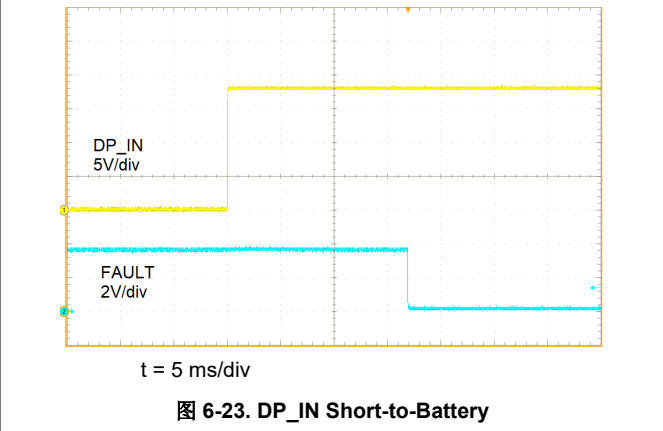
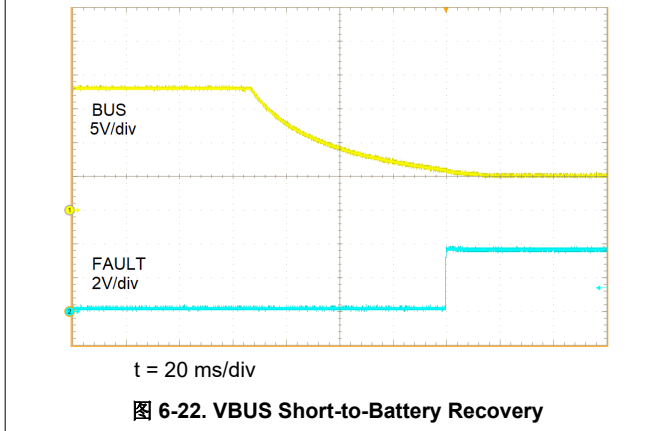
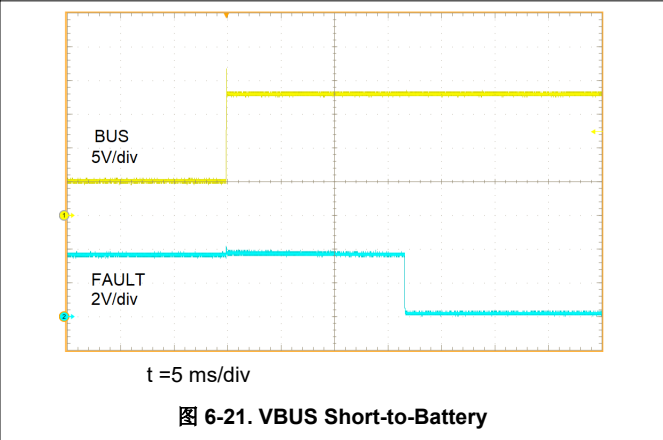
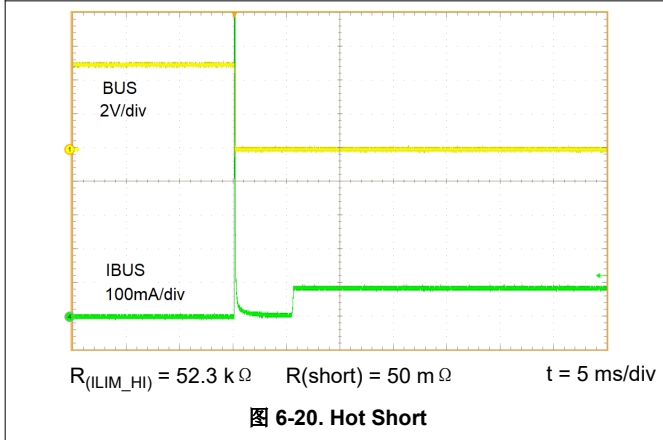
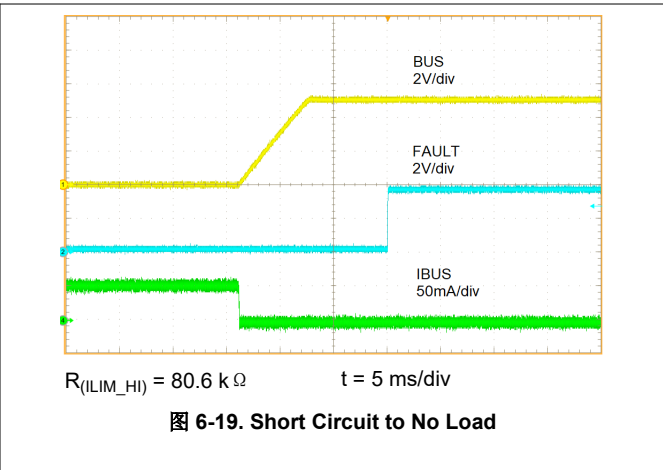
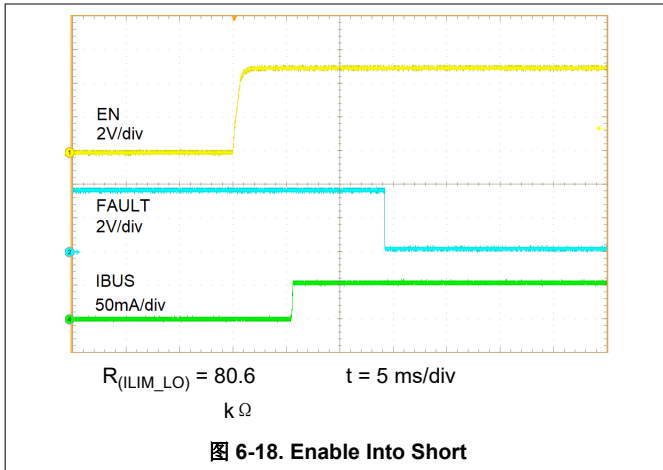

## 6.7 Typical Characteristics (continued)

$T_A = 25^\circ\text{C}$ ,  $V_{(IN)} = 5\text{ V}$ ,  $V_{(EN)} = V_{(IN)}$ ,  $V_{(ILIM\_SEL)} = V_{(INT1)} = V_{(IN)}$ ,  $V_{(INT2)} = \text{GND}$ ,  $\overline{\text{FAULT}}$  connect to  $V_{(IN)}$  via a 10-k $\Omega$  pullup resistor (unless stated otherwise)

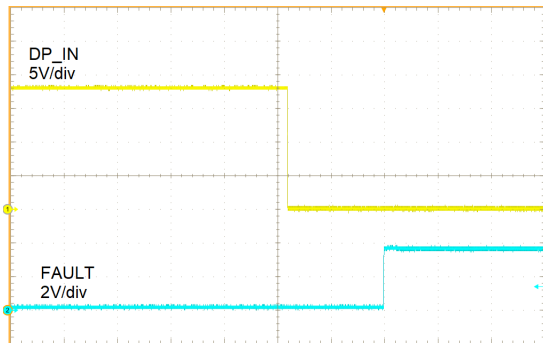

$R_{(\text{BIAS})} = 5.1\text{ k}\Omega$   $t = 20\text{ ms/div}$

图 6-24. DP\_IN Short-to-Battery Recovery

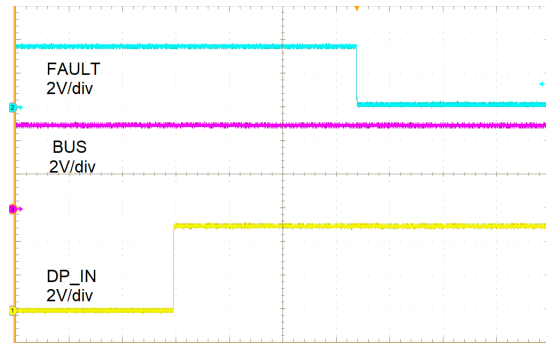

$R_{(\text{BIAS})} = 5.1\text{ k}\Omega$   $t = 5\text{ ms/div}$

图 6-25. DP\_IN Short-to- $V_{\text{BUS}}$

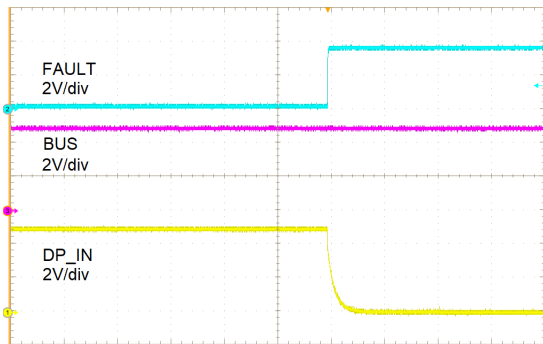

$R_{(\text{BIAS})} = 5.1\text{ k}\Omega$   $t = 2\text{ ms/div}$

图 6-26. DP\_IN Short-to- $V_{\text{BUS}}$  and Recovery



图 6-27. Data Transmission Characteristics vs Frequency



图 6-28. Off-State Data-Switch Isolation vs Frequency

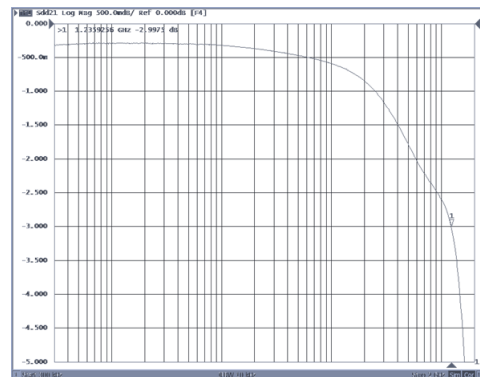

图 6-29. On-State Cross-Channel Isolation vs Frequency

## 7 Parameter Measurement Information

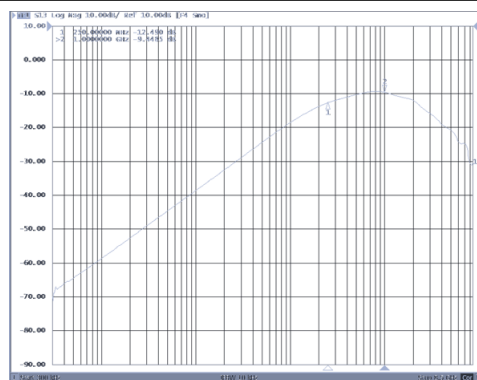

图 7-1. Short-to-Battery System Test Setup

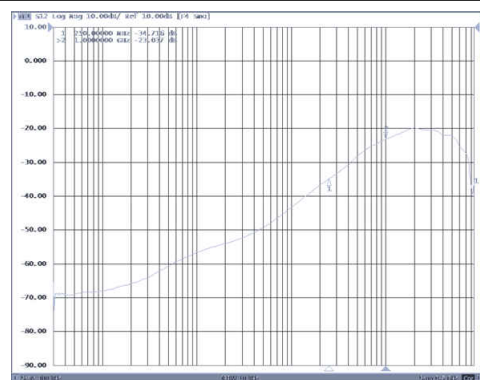
## 8 Detailed Description

### 8.1 Overview

The TPD3S713-Q1 is a single-chip solution for short-to-battery, short-circuit, and ESD protection for high speed data and power lines in automotive USB hub, head unit, telematics, and media interface applications. The integrated data switches provide best-in-class bandwidth for minimal signal degradation during USB short-to-battery events. The high bandwidth allows for a clean USB2.0 high-speed eye diagram which helps pass stringent USB certification tests in the automotive USB environment.

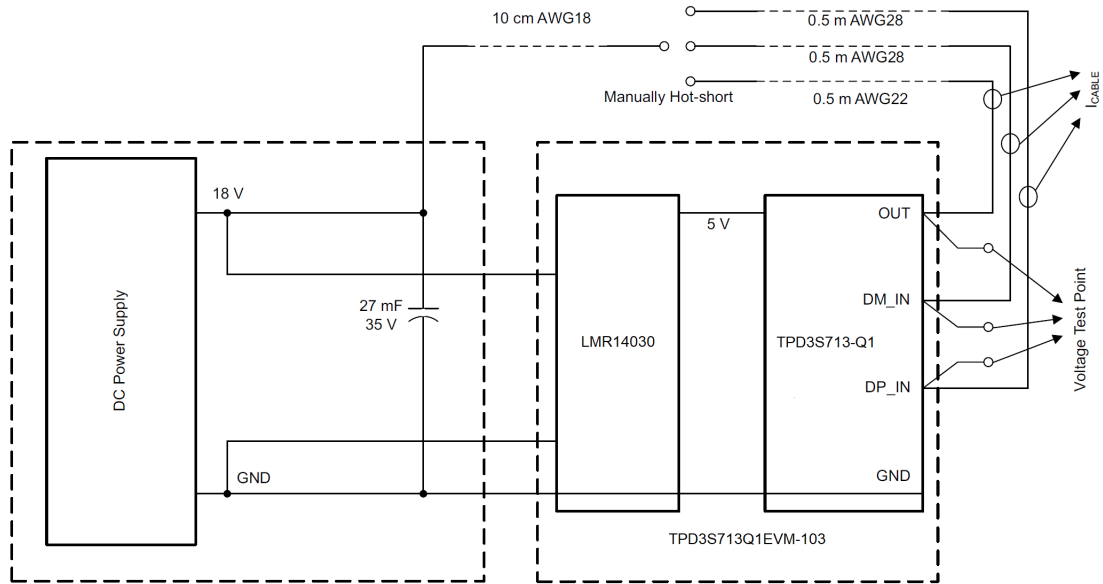
The short-to-battery protection isolates the internal system circuits from any overvoltage conditions at the  $V_{BUS}$ , DP\_IN, and DM\_IN pins. On these pins, the TPD3S713-Q1 can handle overvoltages up to 18 V for hot plug and DC events. This feature protects the upstream voltage regulator, automotive processor, and hub when these pins are exposed to fault conditions.

The  $V_{BUS}$  pin also provides an accurate current limited load switch from 55 mA to 600 mA. The leading overcurrent protection automatically limits current to prevent drooping of the upstream rail during short-to-ground events. Also TPD3S713-Q1 can save power budget for the whole system.

The TPD3S713-Q1 device integrates a cable compensation (CS) feature to compensate for long-cable voltage drop. This feature keeps the remote USB port output voltage constant to enhance the user experience under high-current charging conditions.

The TPD3S713-Q1 device provides a current-monitor function (IMON) by connecting a resistor from the IMON pin to GND to provide a positive voltage linearly with load current. This connection can be used for system power or dynamic power management.

Additionally, the device provides ESD protection up to  $\pm 8$  kV (contact discharge) and  $\pm 15$  kV (air discharge) per IEC 61000-4-2 on DP\_IN and DM\_IN.

## 8.2 Functional Block Diagram

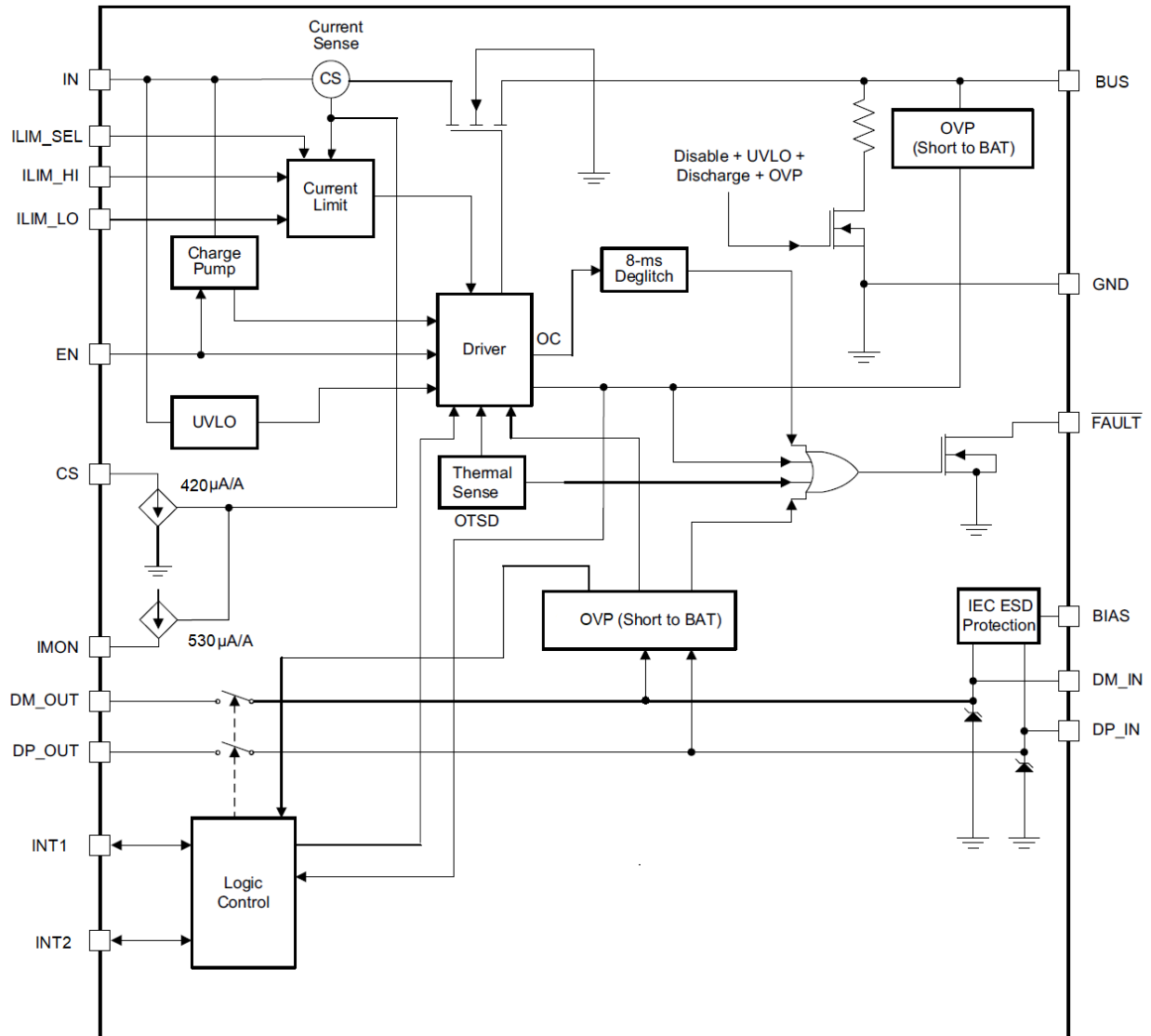

## 8.3 Feature Description

### 8.3.1 FAULT Response

The device features an active-low, open-drain fault output.  $\overline{\text{FAULT}}$  goes low when there is a fault condition. Fault detection includes overtemperature, overcurrent, or overvoltage on  $V_{\text{BUS}}$ ,  $\text{DP\_IN}$  and  $\text{DM\_IN}$ . Connect a 10-k  $\Omega$  pullup resistor from  $\overline{\text{FAULT}}$  to IN.

表 8-1 summarizes the conditions that generate a fault and actions taken by the device.



表 8-1. Fault Conditions

EVENT	CONDITION	ACTION
Overvoltage on the data lines	$V_{(DP\_IN)}$ or $V_{(DM\_IN)} > 3.9\text{ V}$	The device immediately shuts off the USB data switches and the internal power switch. The fault indicator asserts with a 16-ms deglitch, and deasserts without deglitch.
Overvoltage on $V_{(BUS)}$	$V_{(BUS)} > 6\text{ V}$	The device immediately shuts off the internal power switch and the USB data switches. The fault indicator asserts with a 16-ms deglitch and deasserts without deglitch.
Overcurrent on $V_{(BUS)}$	$I_{(BUS)} > I_{(OS)}$	The device regulates switch current at $I_{(OS)}$ until thermal cycling occurs. The fault indicator asserts and deasserts with an 8-ms deglitch.
Overtemperature	$T_J > OTSD2$ in non-current-limited or $T_J > OTSD1$ in current-limited mode.	The device immediately shuts off the internal power switch and the USB data switches. The fault indicator asserts immediately when the junction temperature exceeds $OTSD2$ or $OTSD1$ while in a current-limiting condition. The device has a thermal hysteresis of $20^\circ\text{C}$ .

### 8.3.2 Cable Compensation

When a load draws current through a long or thin wire, there is an IR drop that reduces the voltage delivered to the load. In the vehicle from the voltage regulator 5-V output to the loading, the total resistance of power switch  $r_{DS(on)}$  and cable resistance causes an IR drop at the loading input. So the charging current of most portable devices is less than their expected maximum charging current.



图 8-1. Voltage Drop

The TPD3S713-Q1 device detects the load current and applies a proportional sink current that can be used to adjust the output voltage of the upstream regulator to compensate for the IR drop in the charging path. The gain  $G_{(CS)}$  of the sink current proportional to load current is  $420\ \mu\text{A/A}$ .

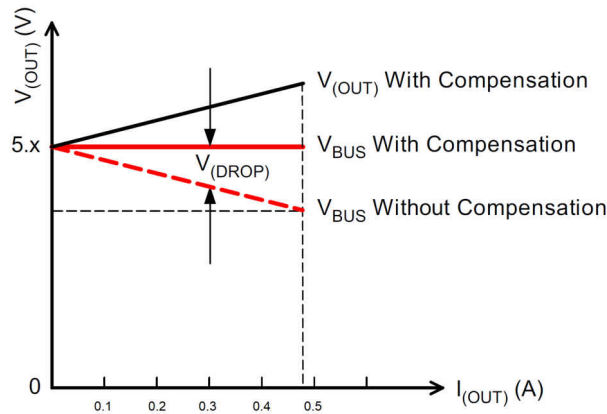

图 8-2. Cable Compensation Equivalent Circuit

### 8.3.2.1 Design Procedure

To start the procedure, the total resistance, including the power switch  $r_{DS(on)}$  and wire resistance  $R_{(WIRE)}$ , must be known.

1. Choose  $R_{(G)}$  following the voltage-regulator feedback resistor-divider design guideline.
2. Calculate  $R_{(FA)}$  according to 方程式 1.

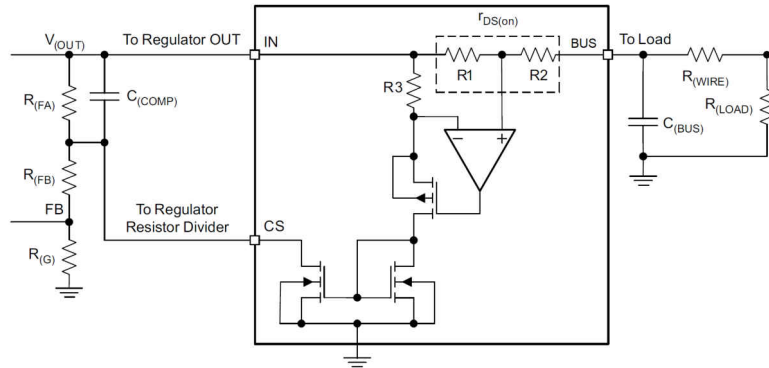
$$R_{FA} = (r_{DS(on)} + R_{(WIRE)}) / G_{(CS)} \quad (1)$$

3. Calculate  $R_{(FB)}$  according to 方程式 2.

$$R_{(FB)} = \frac{V_{(OUT)}}{V_{(FB)} / R_{(G)}} - R_{(G)} - R_{(FA)} \quad (2)$$

4.  $C_{(COMP)}$  in parallel with  $R_{(FA)}$  is required to stabilize  $V_{(OUT)}$  when  $C_{(BUS)}$  is large. Start with  $C_{(COMP)} \geq 3 \times G_{(CS)} \times C_{(OUT)}$ , then adjust  $C_{(COMP)}$  to optimize the load transient of the voltage regulator output.  $V_{(OUT)}$  stability must always be verified in the end application circuit.

### 8.3.3 DP and DM Protection

DP and DM protection consists of ESD and OVP (overvoltage protection). The DP\_IN and DM\_IN pins provide ESD protection up to  $\pm 15$  kV (air discharge) and  $\pm 8$  kV (contact discharge) per IEC 61000-4-2 (see the [ESD Ratings](#) section for test conditions).

The ESD stress seen at DP\_IN and DM\_IN is impacted by many external factors, like the parasitic resistance and inductance between ESD test points and the DP\_IN and DM\_IN pins. For air discharge, the temperature and humidity of the environment can cause some difference, so the IEC performance must always be verified in the end-application circuit.

The IEC ESD performance of the TPD3S713-Q1 device depends on the capacitance connected from BIAS to GND. TI recommends a 2.2- $\mu$ F capacitor placed close to the BIAS pin. Connect the BIAS pin to BUS using a 5.1-k $\Omega$  resistor as a discharge path for the ESD stress.

OVP protection is provided for short-to- $V_{BUS}$  or short-to-battery conditions in the vehicle harness, preventing damage to the upstream USB transceiver or hub. When the voltage on DP\_IN or DM\_IN exceeds 3.9 V (typical), the TPD3S713-Q1 device quickly responds to block the high-voltage reverse connection to DP\_OUT and DM\_OUT. Overcurrent short-to-GND protection for DP and DM is provided by the upstream USB transceiver.

### 8.3.4 $V_{BUS}$ OVP Protection

The TPD3S713-Q1 BUS pin can withstand up to 18 V. The internal MOSFET turns off quickly when a short-to-battery condition occurs.

The TPD3S713-Q1 device OVP threshold is 6 V (typical).

### 8.3.5 Output and DP or DM Discharge

When an OVP condition occurs on DP\_IN or DM\_IN, the TPD3S713-Q1 device enables an internal 200-k $\Omega$  discharge resistance from DP\_IN to ground and from DM\_IN to ground. The analog switches are also turned off. The TPD3S713-Q1 device automatically disables the discharge paths and turns on the analog switches after the OVP condition is removed.

When an OVP condition occurs on BUS, the TPD3S713-Q1 device turns on an internal discharge path (see [表 8-2](#) for the discharge resistance). The TPD3S713-Q1 device automatically turns off the discharge path and turns on the power switch after the OVP condition is removed.

表 8-2. BUS Discharge Resistance

VIN <sup>(1)</sup>	EN <sup>(1)</sup>	OVP <sup>(1)</sup>	BUS DISCHARGE RESISTANCE <sup>(2)</sup>
0	0	0	—
0	0	1	80 kΩ
0	1	0	—
0	1	1	80 kΩ
1	0	0	500 Ω
1	0	1	55 kΩ
1	1	0	—
1	1	1	55 kΩ

(1) 0 = inactive, 1 = active

(2) — = no discharge resistance

### 8.3.6 Overcurrent Protection

When an overcurrent condition is detected, the device maintains a constant output current and reduces the output voltage accordingly. Two possible overload conditions can occur. In the first condition, the output is shorted before the device is enabled or before the application of  $V_{(IN)}$ . The TPD3S713-Q1 device senses the short and immediately switches into a constant-current output. In the second condition, a short or an overload occurs while the device is enabled. At the instant the overload occurs, high currents flow for 1 to 2  $\mu$ s (typical) before the current-limit circuit reacts. The device operates in constant-current mode after the current-limit circuit has responded. Complete shutdown occurs only if the fault is present long enough to activate thermal limiting. The device remains off until the junction temperature cools approximately 20°C and then restarts. The device continues to cycle on and off until the overcurrent condition is removed.

### 8.3.7 Undervoltage Lockout

The undervoltage lockout (UVLO) circuit disables the power switch until the input voltage reaches the UVLO turnon threshold. Built-in hysteresis prevents unwanted oscillations on the output due to input voltage drop from large current surges.

### 8.3.8 Thermal Sensing

Two independent thermal-sensing circuits protect the TPD3S713-Q1 device if the temperature exceeds recommended operating conditions. These circuits monitor the operating temperature of the power-distribution switch and disable operation. The power dissipation in the package is proportional to the voltage drop across the power switch, so the junction temperature rises during an overcurrent condition. The first thermal sensor turns off the power switch when the die temperature exceeds 135°C and the device is in current limit. The second thermal sensor turns off the power switch when the die temperature exceeds 155°C regardless of whether the power switch is in current limit. Hysteresis is built into both thermal sensors, and the switch turns on after the device has cooled by approximately 20°C. The switch continues to cycle off and then on until the fault is removed. The open-drain false-reporting output, FAULT, is asserted (low) during an overtemperature shutdown condition.

### 8.3.9 Current-Limit Setting

The TPD3S713-Q1 has two independent current-limit settings that are each adjusted externally with a resistor. The ILIM\_HI setting is adjusted with  $R_{(ILIM\_HI)}$  connected between ILIM\_HI and GND. The ILIM\_LO setting is adjusted with  $R_{(ILIM\_LO)}$  connected between ILIM\_LO and GND.

The current limit is selected by ILIM\_SEL pin. If ILIM\_SEL = high, ILIM\_HI is selected; If ILIM\_SEL = low, ILIM\_LO is selected.

The following equation calculates the value of resistor for adjusting the typical current limit (need update):

$$I_{os(nom)}(\text{mA}) = \frac{4200\text{V}}{R_{(ILIM\_xx)}^{0.99} \text{k}\Omega} \quad (3)$$

Many applications require that the current limit meet specific tolerance limits. When designing to these tolerance limits, both the tolerance of the TPD3S713-Q1 current limit and the tolerance of the external adjusting resistor must be taken into account. The following equations approximate the TPD3S713-Q1 minimum and maximum current limits to within a few milliamperes and are appropriate for design purposes. The equations do not constitute part of TI's published device specifications for purposes of TI's product warranty. These equations assume an ideal—no variation—external adjusting resistor. To take resistor tolerance into account, first determine the minimum and maximum resistor values based on its tolerance specifications and use these values in the equations. Because of the inverse relation between the current limit and the adjusting resistor, use the maximum resistor value in the  $I_{OS(\min)}$  equation and the minimum resistor value in the  $I_{OS(\max)}$  equation.

$$I_{os(\min)}(\text{mA}) = \frac{4150\text{V}}{R_{(ILIM\_xx)}^{1.05} \text{k}\Omega} \quad (4)$$

$$I_{os(\max)}(\text{mA}) = \frac{4600\text{V}}{R_{(ILIM\_xx)}^{0.96} \text{k}\Omega} \quad (5)$$



图 8-3. Current-Limit Setting vs Adjusting Resistor

The routing of the traces to the  $R_{(ILIM\_xx)}$  resistors must have a sufficiently low resistance so as not to affect the current-limit accuracy. The ground connection for the  $R_{(ILIM\_xx)}$  resistors is also very important. The resistors must reference back to the TPD3S713-Q1 GND pin. Follow normal board layout practices to ensure that current flow from other parts of the board does not impact the ground potential between the resistors and the TPD3S713-Q1 GND pin.

## 8.4 Device Functional Modes

### 8.4.1 Device Truth Table (TT)

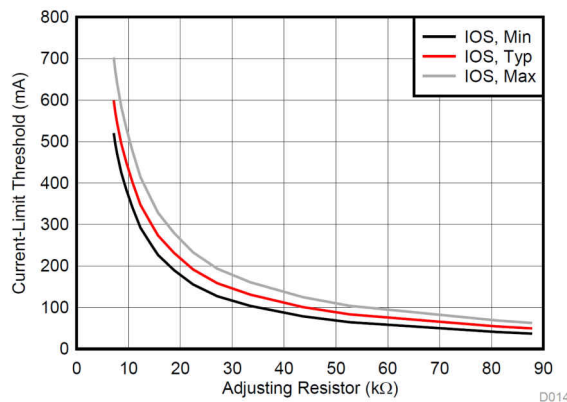
The device truth table (表 8-3) lists all valid combinations for both ILIM\_SEL and INT1 pins, and the corresponding mode. The TPD3S713-Q1 device monitors the INT1 and ILIMI\_SEL input change, and there is 2s discharge on BUS pin during mode change.

表 8-3. Truth Table

INT1	ILIM_SEL	CURRENT LIMIT SELECTED	MODE	POWER SWITCH	DATA SWITCH	IMON FOR CURRENT MONITOR	FAULT REPORT
0	0	N/A	Client mode	OFF	ON	OFF	ON <sup>(1)</sup>
0	1	RESERVED, DO NOT USE					
1	0	ILIM_LO	Normal mode	ON	ON	ON	ON
1	1	ILIM_HI	Normal mode	ON	ON	ON	ON

(1) In the client mode, the FAULT only reports in case of BUS, DP\_IN and DM\_IN OVP.

### 8.4.2 Client Mode

The TPD3S713-Q1 device integrates client mode as shown in 图 8-4. The internal power switch is OFF to block current flow from BUS to IN, and the signal switches are ON. This mode can be used for software upgrades from the USB port.

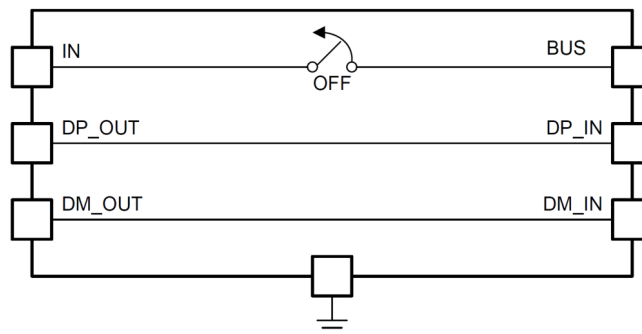

Copyright © 2019, Texas Instruments Incorporated

图 8-4. Client-Mode Equivalent Circuit

In client mode, because the power switch is OFF, BUS must be 5 V so that the device can work normally (usually powered by an external downstream USB port). If the BUS voltage is low, the communication may not work properly.

### 8.4.3 High-Bandwidth Data-Line Switch

The DP and DM data lines pass through the device. A wide-bandwidth signal switch allows data to pass through the device without corrupting signal integrity. The data-line switches are turned on in any of the operating modes. The EN input must be at logic high for the data-line switches to be enabled.

备注

- While in client and normal mode, the data switches are ON.
- The data switches are only for the USB-2.0 differential pair. In the case of a USB-3.0 host, the super-speed differential pairs must be routed directly to the USB connector without passing through the TPD3S713-Q1 device.
- Data switches are OFF during BUS ( $V_{BUS}$ ) discharge.

## 9 Application and Implementation

### 备注

以下应用部分中的信息不属于 TI 器件规格的范围，TI 不担保其准确性和完整性。TI 的客户应负责确定器件是否适用于其应用。客户应验证并测试其设计，以确保系统功能。

### 9.1 Application Information

The TPD3S713-Q1 device is a USB power switch with cable compensation and short-to-battery protection for  $V_{BUS}$ , DP, and DM. The device is typically used for automotive USB port protection. The following design procedure can be used to select components for the TPD3S713-Q1 device. This section presents a simplified discussion of how to choose external components for  $V_{BUS}$ , DP, and DM short-to-battery protection.

### 9.2 Typical Application

For an automotive USB charging port, the  $V_{BUS}$ , DP, and DM pins are exposed and require a protection device. The protection required includes  $V_{BUS}$  overcurrent, DP and DM ESD protection, and short-to-battery protection. This charging-port device protects the upstream dc-dc converter (bus line) and automotive SOC or hub chips (DP and DM data lines). 图 9-1 shows an application schematic of this circuit with short-to-battery protection.



图 9-1. Typical Application Schematic

#### 9.2.1 Design Requirements

For this design example, use the following as the input parameters.

DESIGN PARAMETER	EXAMPLE VALUE
Battery voltage, $V_{(BAT)}$	18 V
Short-circuit cable	0.5 m

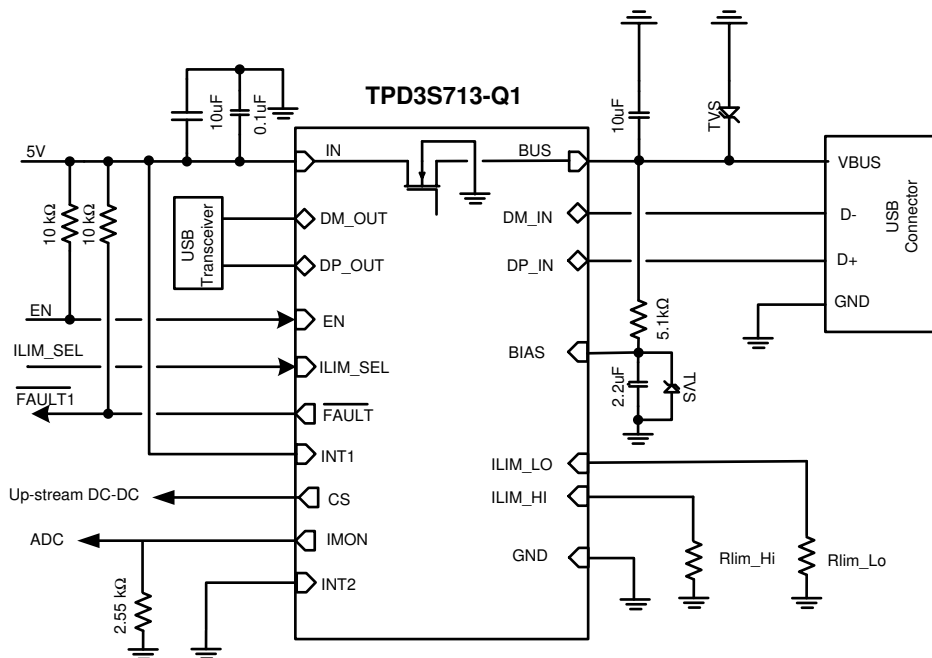
#### 9.2.2 Detailed Design Procedure

To begin the design process, the designer must know the following:

- The battery voltage.
- The short-circuit cable length.

- The maximum continuous output current for the USB port. The minimum current-limit setting of TPD3S713-Q1 device must be higher than this current.
- The maximum output current of the upstream dc-dc converter. The maximum current-limit setting of TPD3S713-Q1 device must be lower than this current.
- For cable compensation, the total resistance including power switch  $r_{DS(on)}$ , cable resistance, and connector contact resistance must be specified.

### 9.2.2.1 Input Capacitance

Consider the following application situations when choosing the input capacitors.

For all applications, TI recommends a 0.1- $\mu$ F or greater ceramic bypass capacitor between IN and GND, placed as close as possible to the device for local noise decoupling.

During output short or hot plug-in of a capacitive load, high current flows through the TPD3S713-Q1 device back to the upstream dc-dc converter until the TPD3S713-Q1 device responds (after  $t_{(IOS)}$ ). During this response time, the TPD3S713-Q1 input capacitance and the dc-dc converter output capacitance source current to keep  $V_{IN}$  above the UVLO of the TPD3S713-Q1 device and any shared circuits. Size the input capacitance for the expected transient conditions and keep the path between the TPD3S713-Q1 device and the dc-dc converter short to help minimize voltage drops.

Input voltage overshoots can be caused by either of two effects. The first cause is an abrupt application of input voltage in conjunction with input power-bus inductance and input capacitance when the IN pin is in the high-impedance state (before turnon). Theoretically, the peak voltage is 2 times the applied voltage. The second cause is due to the abrupt reduction of output short-circuit current when the TPD3S713-Q1 device turns off and energy stored in the input inductance drives the input voltage high. Applications with large input inductance (for example, a connection between the evaluation board and the bench power supply through long cables) may require large input capacitance to prevent the voltage overshoot from exceeding the absolute-maximum voltage of the device.

During the short-to-battery (EN = HIGH) condition, the input voltage follows the output voltage until OVP protection is triggered ( $t_{(OV\_BUS)}$ ). After the TPD3S713-Q1 device responds and turns off the power switch, the stored energy in the input inductance can cause ringing.

Based on the three situations described, TI recommends 10- $\mu$ F and 0.1- $\mu$ F low-ESR ceramic capacitors, placed close to the input.

### 9.2.2.2 Output Capacitance

Consider the following application situations when choosing the output capacitors.

After an output short occurs, the TPD3S713-Q1 device abruptly reduces the BUS current, and the energy stored in the output power-bus inductance causes voltage undershoot and potentially reverse voltage as it discharges.

Applications with large output inductance (such as from a cable) benefit from the use of a high-value output capacitor to control the voltage undershoot.

For USB port applications, because the  $V_{BUS}$  pin is exposed to IEC61000-4-2 level-4 ESD, use a low-ESR capacitance to protect BUS.

The TPD3S713-Q1 device is capable of handling up to 18-V battery voltage. When  $V_{BUS}$  is shorted to the battery, the LCR tank circuit formed can induce ringing. The peak voltage seen on the BUS pin depends on the short-circuit cable length. The parasitic inductance and resistance varies with length, causing the damping factor and peak voltage to differ. Longer cables with larger resistance reduce the peak current and peak voltage. Consider high-voltage derating for the ceramic capacitor, because the peak voltage can be higher than twice the battery voltage.

Based on the three situations described, TI recommends a 10- $\mu$ F, 35-V, X7R, 1210 low-ESR ceramic capacitor placed close to BUS. If the battery voltage is 16 V and a 16-V transient voltage suppressor (TVS) is used, then the capacitor voltage can be reduced to 25 V. Considering temperature variation, placing an additional 35-V aluminum electrolytic capacitor can lower the peak voltage and make the system more robust.



### 9.2.2.3 BIAS Capacitance

The capacitance on the BIAS pin helps the IEC ESD performance on the DM\_IN and DP\_IN pins.

When a short-to-battery on DP\_IN, DM\_IN, BUS, or both occurs, high voltage can be seen on the BIAS pin. Place a 2.2- $\mu$ F, 50-V, X7R, 0805, low-ESR ceramic capacitor close to the BIAS pin. The whole current path from BIAS to GND must be as short as possible. Additionally, use a 5.1-k $\Omega$  discharge resistor from BIAS to BUS.

### 9.2.2.4 Output and BIAS TVS

The TPD3S713-Q1 device can withstand high transient voltages up to 18 V. In real application, the ringing can exceed 18 V due to LCR tank ringing, but to make BUS, DP\_IN, and DM\_IN robust, place one TVS close to the BUS pin, and another TVS close to the BIAS pin. When choosing the TVS, the reverse standoff voltage  $V_R$  depends on the battery voltage (16 V or 18 V). Considering the peak pulse power capability, TI recommends a 400-W device such as an SMAJ16 for a 16-V battery or an SMAJ18 for an 18-V battery.

### 9.2.3 Application Curves



图 9-2. Disabled, 25-V, 1206, X7R C<sub>OUT</sub> Capacitor Without SMAJ16



图 9-3. Disabled, 35-V, 1210, X7R C<sub>OUT</sub> Capacitor Without SMAJ18

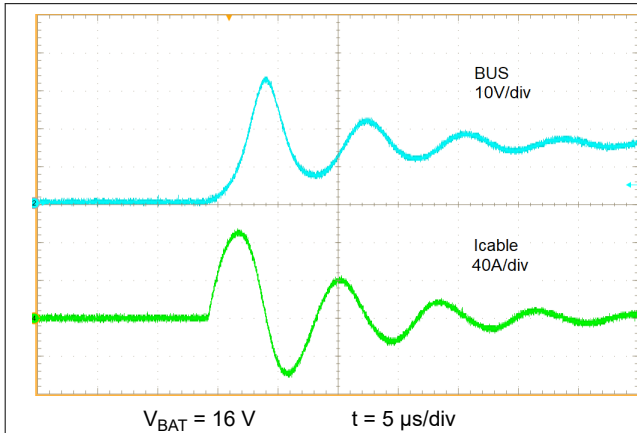

图 9-4. Disabled, 25-V, 1206, X7R C<sub>OUT</sub> Capacitor With SMAJ16, BUS Shorted to Battery

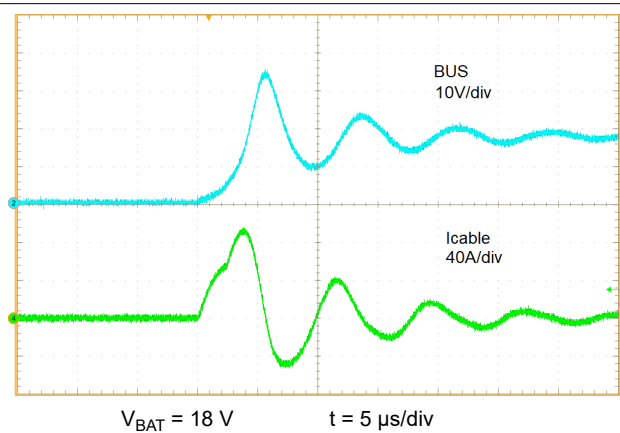

图 9-5. Disabled, 35-V, 1210, X7R C<sub>OUT</sub> Capacitor With SMAJ18, BUS Shorted to Battery

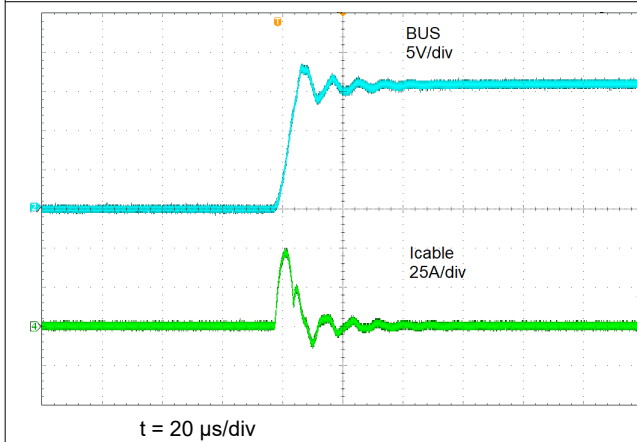

图 9-6. DC-DC VIN Floating, BUS Shorted to Battery

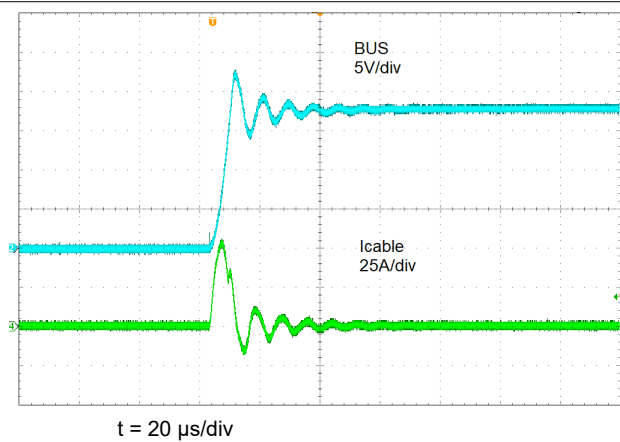

图 9-7. Enable BUS Shorted to Battery

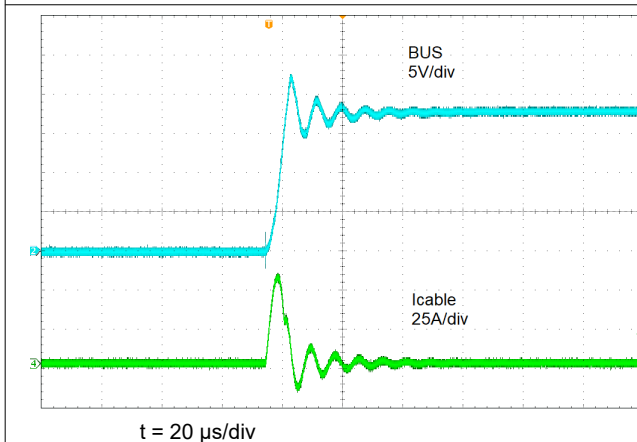

图 9-8. Disabled, DP\_IN Shorted to Battery

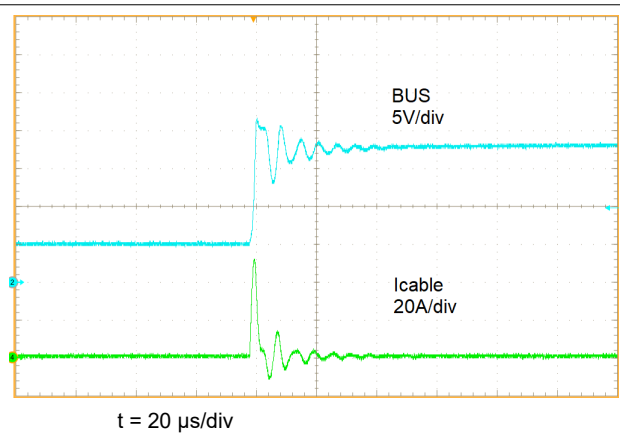

图 9-9. DC-DC VIN Floating, DP\_IN Shorted to Battery

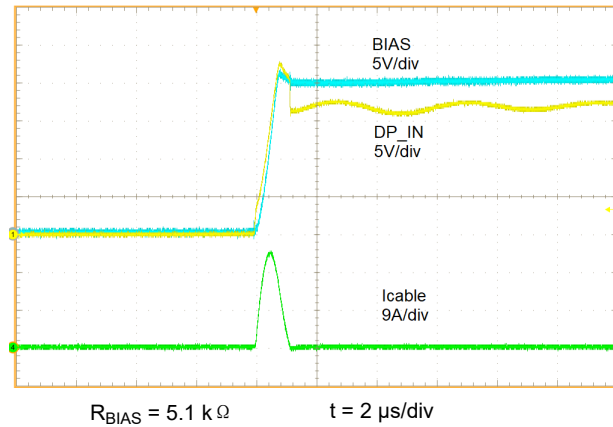

图 9-10. Enabled, DP\_IN Shorted to Battery

R<sub>(DP\_OUT)</sub> = 15 kΩ

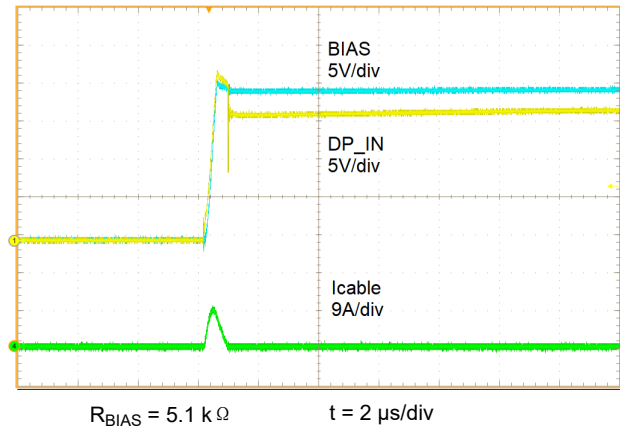
## 10 Power Supply Recommendations

The TPD3S713-Q1 device is designed for a supply voltage range of  $4.5\text{ V} \leq V_{IN} \leq 5.5\text{ V}$ , with its power switch used for protecting the upstream power supply when a fault such as overcurrent or short to ground occurs on the USB port. Therefore, the power supply must be rated higher than the current-limit setting to avoid voltage drops during overcurrent or short-circuit conditions.

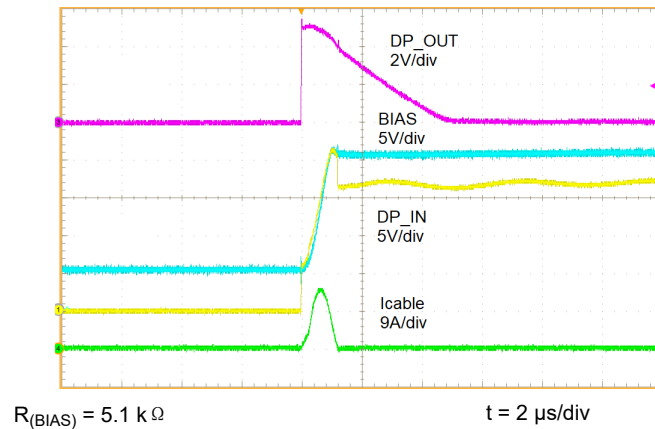
## 11 Layout

### 11.1 Layout Guidelines

Layout best practices for the TPD3S713-Q1 device are listed as follows:

- Considerations for input and output power traces:
  - Make the power traces as short as possible.
  - Make the power traces as wide as possible.
- Considerations for input-capacitor traces:
  - For all applications, TI recommends 10-μF and 0.1-μF low-ESR ceramic capacitors, placed close to the IN pin.
- The resistors attached to the ILIM\_HI and ILIM\_LO pins of the device have several requirements:
  - TI recommends to use 1% low-temperature-coefficient resistors.
  - The trace routing between these two pins and GND must be as short as possible to reduce parasitic effects on current limit. These traces must not have any coupling to switching signals on the board.

- Locate all TPD3S713-Q1 pullup resistors for open-drain outputs close to their connection pin. Pullup resistors must be 100 k $\Omega$ .
  - If a particular open-drain output is not used or needed in the system, tie it to GND.
- ESD considerations:
  - The TPD3S713-Q1 device has built-in ESD protection for DP\_IN and DM\_IN. Keep trace lengths minimal from the USB connector to the DP\_IN and DM\_IN pins on the TPD3S713-Q1 device, and use minimal vias along the traces.
  - The capacitor on BIAS helps to improve the IEC ESD performance. A 2.2- $\mu$ F capacitor must be placed close to BIAS, and the current path from BIAS to GND across this capacitor must be as short as possible. Do not use vias along the connection traces.
  - A 10- $\mu$ F output capacitor must be placed close to the BUS pin and TVS.
  - See the [ESD Protection Layout Guide](#) for additional information.
- TVS Considerations (BUS, DP\_IN and DM\_IN exceed 18 V):
  - For BUS, a TVS like SMAJ18 must be placed near the BUS pin.
  - For BIAS, a TVS like SMAJ18 must be placed close to the BIAS pin, but behind the 2.2- $\mu$ F capacitor.
  - The whole path from BUS to GND or BIAS to GND across the TVS must be as short as possible.
- DP\_IN, DM\_IN, DP\_OUT, and DM\_OUT routing considerations
  - Route these traces as microstrips with nominal differential impedance of 90  $\Omega$ .
  - Minimize the use of vias on the high-speed data lines.
  - Keep the reference GND plane devoid from cuts or splits above the differential pairs to prevent impedance discontinuities.
  - For more USB 2.0 high-speed D+ and D- differential routing information, see the *High Speed USB Platform Design Guideline* from Intel.
- Thermal Considerations:
  - When properly mounted, the thermal-pad package provides significantly greater cooling ability than an ordinary package. To operate at rated power, the thermal pad must be soldered to the board GND plane directly under the device. The thermal pad is at GND potential and can be connected using multiple vias to inner-layer GND. Other planes, such as the bottom side of the circuit board, can be used to increase heat sinking in higher-current applications. See the [PowerPad™ Thermally Enhanced Package application report](#) and ([PowerPAD™ Made Easy application brief](#)) for more information on using this thermal pad package.

## 11.2 Layout Example



图 11-1. TPD3S713-Q1 Layout Diagram

## 12 Device and Documentation Support

### 12.1 Documentation Support

#### 12.1.1 Related Documentation

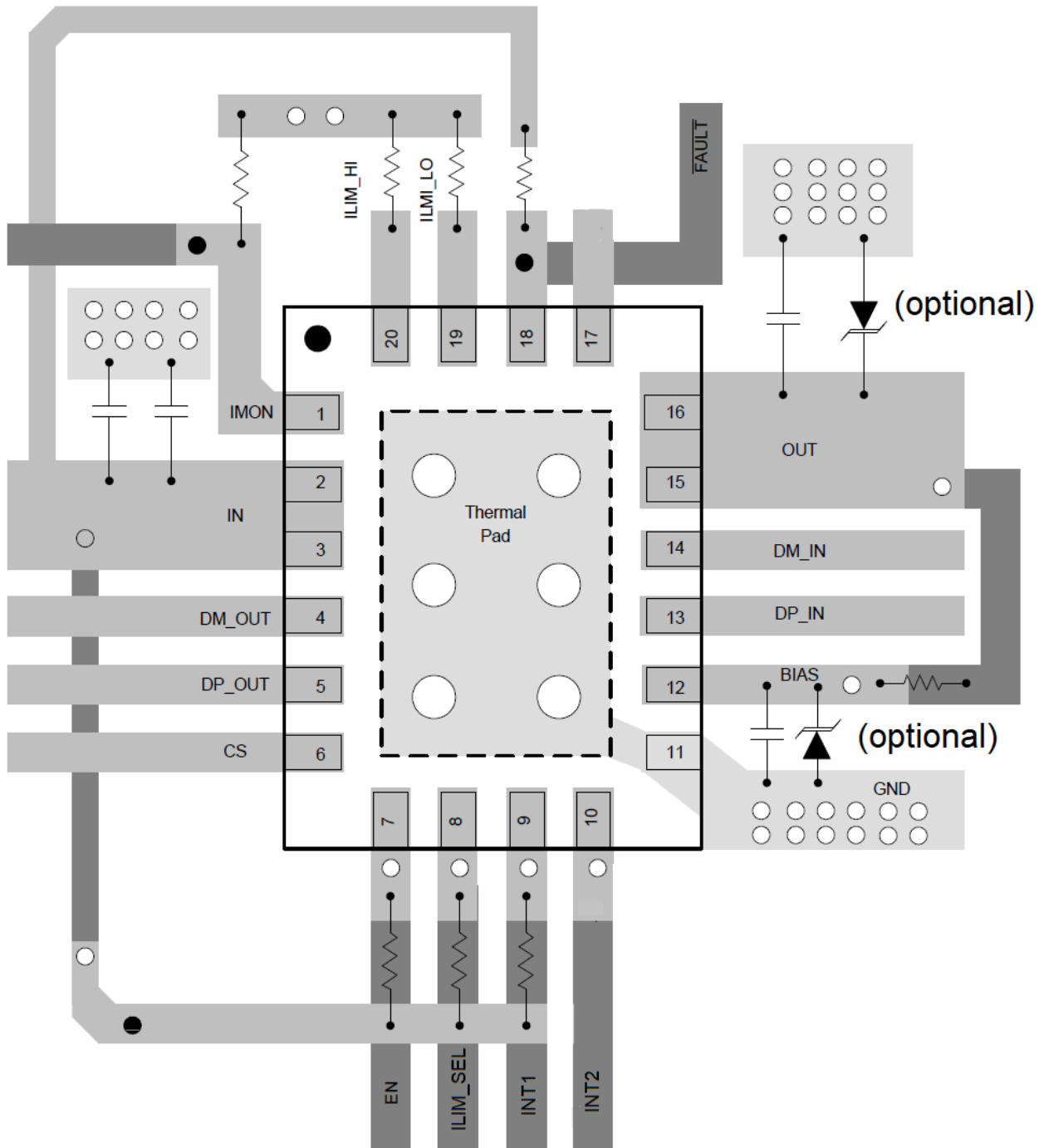
For related documentation see the following:

- *High Speed USB Platform Design Guidelines Intel*
- Texas Instruments, [ESD Protection Layout Guide application note](#)
- Texas Instruments, [PowerPAD™ Thermally Enhanced Package application note](#)
- Texas Instruments, [PowerPAD™ Made Easy application brief](#)

#### 12.2 接收文档更新通知

要接收文档更新通知，请导航至 [ti.com](http://ti.com) 上的器件产品文件夹。点击 [订阅更新](#) 进行注册，即可每周接收产品信息更改摘要。有关更改的详细信息，请查看任何已修订文档中包含的修订历史记录。

#### 12.3 支持资源

[TI E2E™ 支持论坛](#) 是工程师的重要参考资料，可直接从专家获得快速、经过验证的解答和设计帮助。搜索现有解答或提出自己的问题可获得所需的快速设计帮助。

链接的内容由各个贡献者“按原样”提供。这些内容并不构成 TI 技术规范，并且不一定反映 TI 的观点；请参阅 TI 的 [《使用条款》](#)。

#### 12.4 Trademarks

PowerPAD™ and TI E2E™ are trademarks of Texas Instruments.

所有商标均为其各自所有者的财产。

#### 12.5 Electrostatic Discharge Caution



This integrated circuit can be damaged by ESD. Texas Instruments recommends that all integrated circuits be handled with appropriate precautions. Failure to observe proper handling and installation procedures can cause damage.

ESD damage can range from subtle performance degradation to complete device failure. Precision integrated circuits may be more susceptible to damage because very small parametric changes could cause the device not to meet its published specifications.

#### 12.6 术语表

[TI 术语表](#) 本术语表列出并解释了术语、首字母缩略词和定义。

## 13 Mechanical, Packaging, and Orderable Information

The following pages include mechanical, packaging, and orderable information. This information is the most-current data available for the designated device. This data is subject to change without notice and without revision of this document. For browser-based versions of this data sheet, see the left-hand navigation pane.

**PACKAGING INFORMATION**

Orderable Device	Status (1)	Package Type	Package Drawing	Pins	Package Qty	Eco Plan (2)	Lead finish/ Ball material (6)	MSL Peak Temp (3)	Op Temp (°C)	Device Marking (4/5)	Samples
TPD3S713QRVCRQ1	ACTIVE	WQFN	RVC	20	3000	RoHS & Green	NIPDAU	Level-2-260C-1 YEAR	-40 to 125	3S713Q	Samples

(1) The marketing status values are defined as follows:

**ACTIVE:** Product device recommended for new designs.

**LIFEBUY:** TI has announced that the device will be discontinued, and a lifetime-buy period is in effect.

**NRND:** Not recommended for new designs. Device is in production to support existing customers, but TI does not recommend using this part in a new design.

**PREVIEW:** Device has been announced but is not in production. Samples may or may not be available.

**OBSOLETE:** TI has discontinued the production of the device.

(2) **RoHS:** TI defines "RoHS" to mean semiconductor products that are compliant with the current EU RoHS requirements for all 10 RoHS substances, including the requirement that RoHS substance do not exceed 0.1% by weight in homogeneous materials. Where designed to be soldered at high temperatures, "RoHS" products are suitable for use in specified lead-free processes. TI may reference these types of products as "Pb-Free".

**RoHS Exempt:** TI defines "RoHS Exempt" to mean products that contain lead but are compliant with EU RoHS pursuant to a specific EU RoHS exemption.

**Green:** TI defines "Green" to mean the content of Chlorine (Cl) and Bromine (Br) based flame retardants meet JS709B low halogen requirements of <=1000ppm threshold. Antimony trioxide based flame retardants must also meet the <=1000ppm threshold requirement.

(3) MSL, Peak Temp. - The Moisture Sensitivity Level rating according to the JEDEC industry standard classifications, and peak solder temperature.

(4) There may be additional marking, which relates to the logo, the lot trace code information, or the environmental category on the device.

(5) Multiple Device Markings will be inside parentheses. Only one Device Marking contained in parentheses and separated by a "-" will appear on a device. If a line is indented then it is a continuation of the previous line and the two combined represent the entire Device Marking for that device.

(6) Lead finish/Ball material - Orderable Devices may have multiple material finish options. Finish options are separated by a vertical ruled line. Lead finish/Ball material values may wrap to two lines if the finish value exceeds the maximum column width.

**Important Information and Disclaimer:** The information provided on this page represents TI's knowledge and belief as of the date that it is provided. TI bases its knowledge and belief on information provided by third parties, and makes no representation or warranty as to the accuracy of such information. Efforts are underway to better integrate information from third parties. TI has taken and continues to take reasonable steps to provide representative and accurate information but may not have conducted destructive testing or chemical analysis on incoming materials and chemicals. TI and TI suppliers consider certain information to be proprietary, and thus CAS numbers and other limited information may not be available for release.

In no event shall TI's liability arising out of such information exceed the total purchase price of the TI part(s) at issue in this document sold by TI to Customer on an annual basis.

**TAPE AND REEL INFORMATION**

**QUADRANT ASSIGNMENTS FOR PIN 1 ORIENTATION IN TAPE**

\*All dimensions are nominal

Device	Package Type	Package Drawing	Pins	SPQ	Reel Diameter (mm)	Reel Width W1 (mm)	A0 (mm)	B0 (mm)	K0 (mm)	P1 (mm)	W (mm)	Pin1 Quadrant
TPD3S713QRVCRQ1	WQFN	RVC	20	3000	330.0	12.4	3.3	4.3	1.1	8.0	12.0	Q1



**TAPE AND REEL BOX DIMENSIONS**

\*All dimensions are nominal

Device	Package Type	Package Drawing	Pins	SPQ	Length (mm)	Width (mm)	Height (mm)
TPD3S713QRVCRQ1	WQFN	RVC	20	3000	367.0	367.0	35.0

## GENERIC PACKAGE VIEW

RVC 20

WQFN - 0.8 mm max height

PLASTIC QUAD FLATPACK - NO LEAD

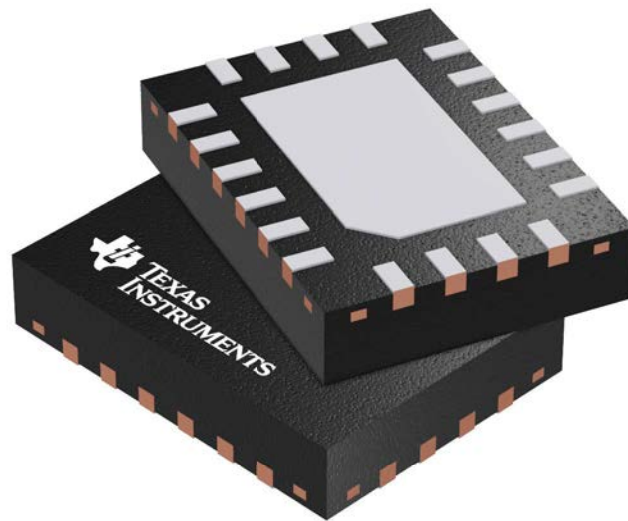

Images above are just a representation of the package family, actual package may vary.  
Refer to the product data sheet for package details.

4209819/B

## 重要声明和免责声明

TI“按原样”提供技术和可靠性数据（包括数据表）、设计资源（包括参考设计）、应用或其他设计建议、网络工具、安全信息和其他资源，不保证没有瑕疵且不做任何明示或暗示的担保，包括但不限于对适销性、某特定用途方面的适用性或不侵犯任何第三方知识产权的暗示担保。

这些资源可供使用 TI 产品进行设计的熟练开发人员使用。您将自行承担以下全部责任：(1) 针对您的应用选择合适的 TI 产品，(2) 设计、验证并测试您的应用，(3) 确保您的应用满足相应标准以及任何其他功能安全、信息安全、监管或其他要求。

这些资源如有变更，恕不另行通知。TI 授权您仅可将这些资源用于研发本资源所述的 TI 产品的应用。严禁对这些资源进行其他复制或展示。您无权使用任何其他 TI 知识产权或任何第三方知识产权。您应全额赔偿因在这些资源的使用中对 TI 及其代表造成的任何索赔、损害、成本、损失和债务，TI 对此概不负责。

TI 提供的产品受 [TI 的销售条款](#) 或 [ti.com](#) 上其他适用条款/TI 产品随附的其他适用条款的约束。TI 提供这些资源并不会扩展或以其他方式更改 TI 针对 TI 产品发布的适用的担保或担保免责声明。

TI 反对并拒绝您可能提出的任何其他或不同的条款。

邮寄地址：Texas Instruments, Post Office Box 655303, Dallas, Texas 75265

Copyright © 2022，德州仪器 (TI) 公司