

TPS22929D 具有受控接通功能的超小型、低导通电阻负载开关

1 特性

- 集成单负载开关
- 小型 SOT23-6 封装
- 输入电压范围：1.4V 至 5.5V
- 低导通电阻
 - 在 $V_{IN} = 5V$ 时, $r_{ON} = 115m\Omega$
 - 在 $V_{IN} = 3.3V$ 时, $r_{ON} = 115m\Omega$
 - 在 $V_{IN} = 2.5V$ 时, $r_{ON} = 118m\Omega$
 - 在 $V_{IN} = 1.5V$ 时, $r_{ON} = 129m\Omega$
- 1.8A 连续开关电流 (25°C)
- 低阈值控制输入
- 受控转换率
- 欠压闭锁
- 快速输出放电
- 反向电流保护

2 应用

- 便携式工业设备
- 便携式医疗设备
- 便携式媒体播放器
- 销售点终端
- 全球卫星定位 (GPS) 设备
- 数码摄像机
- 便携式仪表
- 智能电话

4 简化电路原理图

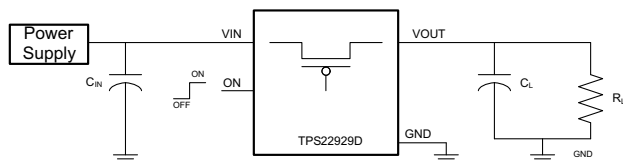

3 说明

TPS22929D 是一款具有受控接通功能的小型、超低 r_{ON} 负载开关。此器件包括一个 P 沟道金属氧化物半导体场效应晶体管 (MOSFET), 可在 1.4V 至 5.5V 的输入电压范围内运行。此开关由一个开/关输入 (ON) 控制, 此输入能够与低电压控制信号直接相连。

TPS22929D 为高电平有效。

TPS22929D 包含一个 150 Ω 片上负载电阻器, 用于在此开关被关闭时进行快速输出放电。此器件的上升时间受到内部控制以避免浪涌电流。

在出现反向电压时, TPS22929D 器件通过闭锁电源开关来提供断路器功能。当输出电压 (V_{OUT}) 被驱动至高于输入 (V_{IN}) 时, 内部反向电压比较器会关闭此电源开关以快速 (典型值为 10 μ s) 阻止流向此开关输入一侧的电流。反向电流一直有效, 甚至当电源开关关闭的时候也是如此。此外, 如果此输入电压过低, 欠压闭锁 (UVLO) 保护会将此开关关闭。

TPS22929D 采用节省空间的小型 6 引脚 SOT23 封装, 自然通风条件下的额定工作温度范围为 $-40^{\circ}C$ 至 $85^{\circ}C$ 。

器件信息(1)

器件型号	封装	封装尺寸 (标称值)
TPS22929D	SOT23 (6)	2.90mm x 1.60mm

(1) 如需了解所有可用封装, 请见数据表末尾的可订购产品附录。

导通状态电阻与输入电压间的关系

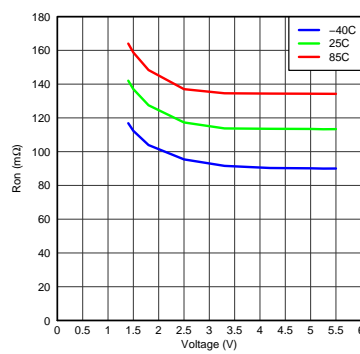

目录

1	特性	1	9.1	Overview	12
2	应用	1	9.2	Functional Block Diagram	12
3	说明	1	9.3	Feature Description	12
4	简化电路原理图	1	9.4	Device Functional Modes	13
5	修订历史记录	2	10	Application and Implementation	14
6	Pin Configuration and Functions	3	10.1	Application Information	14
7	Specifications	3	10.2	Typical Application	14
7.1	Absolute Maximum Ratings	3	11	Power Supply Recommendations	18
7.2	Handling Ratings	4	12	Layout	18
7.3	Recommended Operating Conditions	4	12.1	Layout Guidelines	18
7.4	Thermal Information	4	12.2	Layout Example	19
7.5	Electrical Characteristics	5	13	器件和文档支持	19
7.6	Switching Characteristics	6	13.1	商标	19
7.7	Typical Characteristics	7	13.2	静电放电警告	19
8	Parametric Measurement Information	10	13.3	术语表	19
9	Detailed Description	12	14	机械、封装和可订购信息	19

5 修订历史记录

Changes from Original (December 2011) to Revision A

Page

• 已更新到增强型数据表标准。	1
• Added Handling Ratings table.	4
• Added Thermal Information table.	4
• Added Detailed Description section.	12
• Added Application and Implementation section.	14
• Added Power Supply Recommendations section.	18
• Added Layout section.	18

6 Pin Configuration and Functions

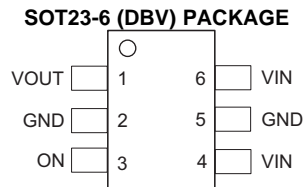

Pin Functions

PIN		DESCRIPTION
NAME	DBV	
GND	2, 5	Ground
ON	3	Switch control input, active high. Do not leave floating
VOUT	1	Switch output
VIN	4, 6	Switch input, bypass this input with a ceramic capacitor to ground

7 Specifications

7.1 Absolute Maximum Ratings

over operating free-air temperature range (unless otherwise noted)

		MIN	MAX	UNIT
V_{IN}	Input voltage range	-0.3	6	V
V_{OUT}	Output voltage range	-0.3	6	V
V_{ON}	Input voltage range	-0.3	6	V
P_{MAX}	Maximum continuous power dissipation at 25°C		463	mW
	Maximum continuous power dissipation at 70°C		254	
	Maximum continuous power dissipation at 85°C		185	
I_{MAX}	Maximum continuous operating current		2	A
T_A	Operating free-air temperature range	-40	85	°C
T_J	Maximum junction temperature		125	°C

7.2 Handling Ratings

		MIN	MAX	UNIT
T _{stg}	Storage temperature range	-65	150	°C
V _(ESD)	Electrostatic discharge	Human body model (HBM), per ANSI/ESDA/JEDEC JS-001, all pins ⁽¹⁾		kV
		Charged device model (CDM), per JEDEC specification JESD22-C101, all pins ⁽²⁾		
		-2	2	
		-1	1	

- (1) JEDEC document JEP155 states that 500-V HBM allows safe manufacturing with a standard ESD control process. Pins listed as 2 kV may actually have higher performance.
- (2) JEDEC document JEP157 states that 250-V CDM allows safe manufacturing with a standard ESD control process. Pins listed as 1 kV may actually have higher performance.

7.3 Recommended Operating Conditions

		MIN	MAX	UNIT
V _{IN}	Input voltage range	1.4	5.5	V
V _{ON}	ON voltage range	0	5.5	V
V _{OUT}	Output voltage range		V _{IN}	
V _{IH}	High-level input voltage, ON	V _{IN} = 1.4 V to 5.5 V		V
V _{IL}	Low-level input voltage, ON	V _{IN} = 3.61 V to 5.5 V		V
		V _{IN} = 1.4 V to 3.6 V		V
C _{IN}	Input Capacitor	1 ⁽¹⁾		μF

- (1) Refer to the application section.

7.4 Thermal Information

THERMAL METRIC ⁽¹⁾		TPS22929D	UNITS
		DBV	
		6 PINS	
R _{θJA}	Junction-to-ambient thermal resistance	216	°C/W
R _{θJctop}	Junction-to-case (top) thermal resistance	209	
R _{θJB}	Junction-to-board thermal resistance	131	
ψ _{JT}	Junction-to-top characterization parameter	52	
ψ _{JB}	Junction-to-board characterization parameter	110	

- (1) For more information about traditional and new thermal metrics, see the *IC Package Thermal Metrics* application report, [SPRA953](#).

7.5 Electrical Characteristics

 $V_{IN} = 1.4\text{ V to }5.5\text{ V}$, $T_A = -40^\circ\text{C to }85^\circ\text{C}$ (unless otherwise noted)

PARAMETER		TEST CONDITIONS	T_A	MIN	TYP	MAX	UNIT
I_{IN}	Quiescent current	$I_{OUT} = 0$, $V_{IN} = V_{ON} = 5.25\text{ V}$	Full		2.2	10	μA
		$I_{OUT} = 0$, $V_{IN} = V_{ON} = 4.2\text{ V}$			2.1	7.0	
		$I_{OUT} = 0$, $V_{IN} = V_{ON} = 3.6\text{ V}$			2.0	7.0	
		$I_{OUT} = 0$, $V_{IN} = V_{ON} = 2.5\text{ V}$			1.0	5.0	
		$I_{OUT} = 0$, $V_{IN} = V_{ON} = 1.5\text{ V}$			0.8	5.0	
$I_{IN(off)}$	Off supply current	$V_{ON} = \text{GND}$, $V_{OUT} = \text{Open}$, $V_{IN} = 5.25\text{ V}$	Full		0.8	10	μA
		$V_{ON} = \text{GND}$, $V_{OUT} = \text{Open}$, $V_{IN} = 4.2\text{ V}$			0.3	7.0	
		$V_{ON} = \text{GND}$, $V_{OUT} = \text{Open}$, $V_{IN} = 3.6\text{ V}$			0.2	7.0	
		$V_{ON} = \text{GND}$, $V_{OUT} = \text{Open}$, $V_{IN} = 2.5\text{ V}$			0.2	5.0	
		$V_{ON} = \text{GND}$, $V_{OUT} = \text{Open}$, $V_{IN} = 1.5\text{ V}$			0.1	5.0	
$I_{IN(Leakage)}$	Leakage current	$V_{ON} = \text{GND}$, $V_{OUT} = 0$, $V_{IN} = 5.25\text{ V}$	Full		0.8	10	μA
		$V_{ON} = \text{GND}$, $V_{OUT} = 0$, $V_{IN} = 4.2\text{ V}$			0.3	7.0	
		$V_{ON} = \text{GND}$, $V_{OUT} = 0$, $V_{IN} = 3.6\text{ V}$			0.2	7.0	
		$V_{ON} = \text{GND}$, $V_{OUT} = 0$, $V_{IN} = 2.5\text{ V}$			0.2	5.0	
		$V_{ON} = \text{GND}$, $V_{OUT} = 0$, $V_{IN} = 1.5\text{ V}$			0.1	5.0	
r_{ON}	On-resistance	$V_{IN} = 5.25\text{ V}$, $I_{OUT} = -200\text{ mA}$	25°C		115	150	$\text{m}\Omega$
			Full			175	
		$V_{IN} = 5.0\text{ V}$, $I_{OUT} = -200\text{ mA}$	25°C		115	150	
			Full			175	
		$V_{IN} = 4.2\text{ V}$, $I_{OUT} = -200\text{ mA}$	25°C		115	150	
			Full			175	
		$V_{IN} = 3.3\text{ V}$, $I_{OUT} = -200\text{ mA}$	25°C		115	150	
			Full			175	
		$V_{IN} = 2.5\text{ V}$, $I_{OUT} = -200\text{ mA}$	25°C		118	155	
			Full			180	
		$V_{IN} = 1.5\text{ V}$, $I_{OUT} = -200\text{ mA}$	25°C		129	170	
			Full			200	
RPD	Output pull down resistance	$V_{IN} = 3.3\text{ V}$, $V_{ON} = 0$, $I_{OUT} = 30\text{ mA}$	25°C		150	200	Ω
UVLO	Under voltage lockout	V_{IN} increasing, $V_{ON} = 3.6\text{ V}$, $I_{OUT} = -100\text{ mA}$	Full			1.4	V
				0.50			
I_{ON}	ON input leakage current	$V_{ON} = 1.4\text{ V to }5.25\text{ V or GND}$	Full			1	μA
V_{RVP}	Reverse Current Voltage Threshold				77		mV
t_{DELAY}	Reverse Current Response Delay	$V_{IN} = 5\text{ V}$			10		μs

7.6 Switching Characteristics

PARAMETER		TEST CONDITION	TPS22929D	UNIT
			TYP	
VIN = 5 V, TA = 25°C (unless otherwise noted)				
t _{ON}	Turn-ON time	R _L = 10 Ω, C _L = 0.1 μF	3315	μs
t _{OFF}	Turn-OFF time	R _L = 10 Ω, C _L = 0.1 μF	7.4	
t _R	VOUT rise time	R _L = 10 Ω, C _L = 0.1 μF	3660	
t _F	VOUT fall time	R _L = 10 Ω, C _L = 0.1 μF	6.1	
VIN = 3.3 V, TA = 25°C (unless otherwise noted)				
t _{ON}	Turn-ON time	R _L = 10 Ω, C _L = 0.1 μF	4655	μs
t _{OFF}	Turn-OFF time	R _L = 10 Ω, C _L = 0.1 μF	9.5	
t _R	VOUT rise time	R _L = 10 Ω, C _L = 0.1 μF	4150	
t _F	VOUT fall time	R _L = 10 Ω, C _L = 0.1 μF	3.0	
VIN = 1.5 V, TA = 25°C (unless otherwise noted)				
t _{ON}	Turn-ON time	R _L = 10 Ω, C _L = 0.1 μF	10175	μs
t _{OFF}	Turn-OFF time	R _L = 10 Ω, C _L = 0.1 μF	18.3	
t _R	VOUT rise time	R _L = 10 Ω, C _L = 0.1 μF	7812	
t _F	VOUT fall time	R _L = 10 Ω, C _L = 0.1 μF	3.0	

7.7 Typical Characteristics

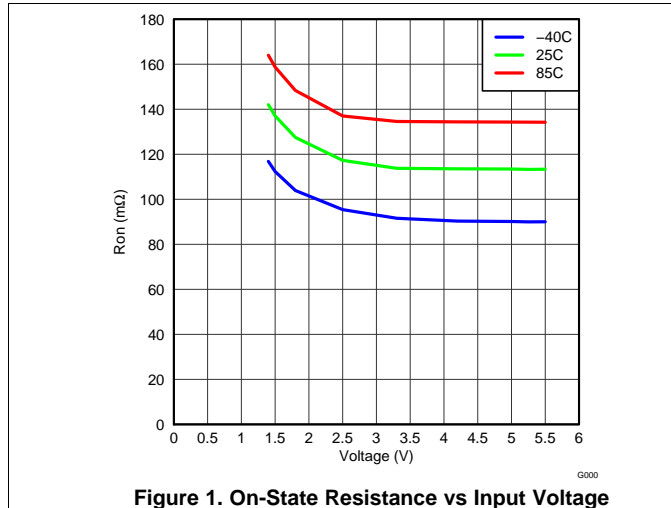

Figure 1. On-State Resistance vs Input Voltage

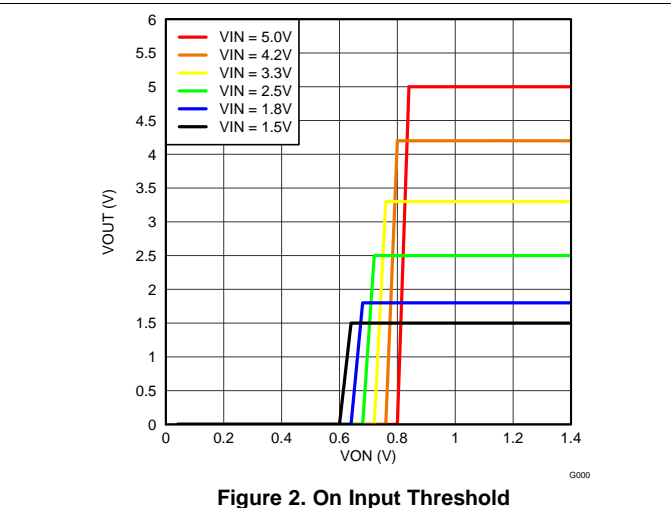

Figure 2. On Input Threshold

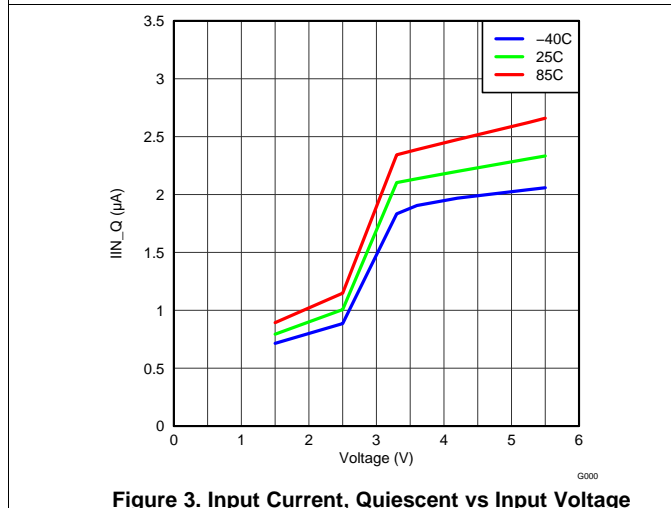

Figure 3. Input Current, Quiescent vs Input Voltage

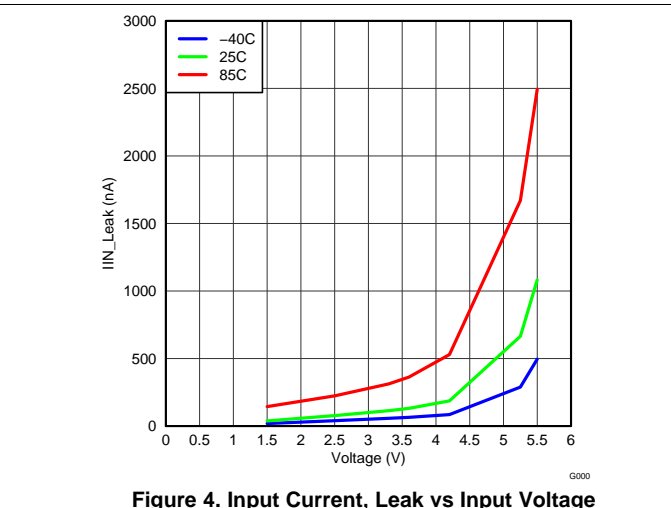

Figure 4. Input Current, Leak vs Input Voltage

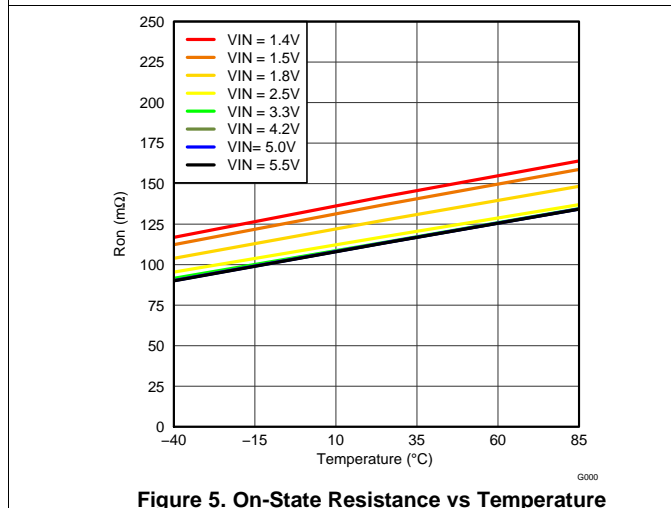

Figure 5. On-State Resistance vs Temperature

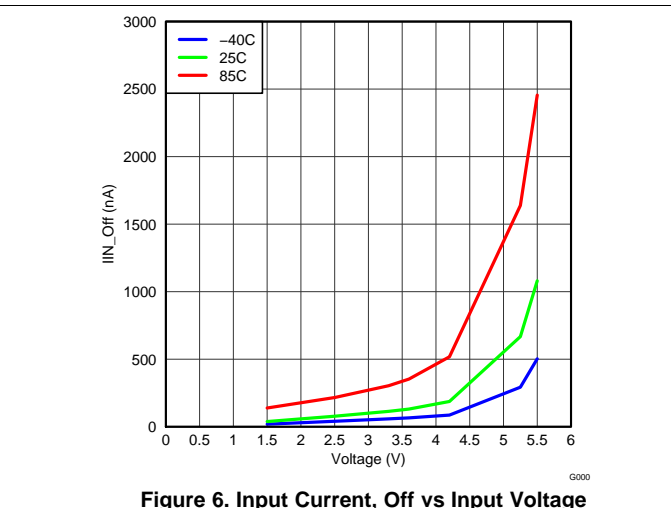

Figure 6. Input Current, Off vs Input Voltage

Typical Characteristics (continued)

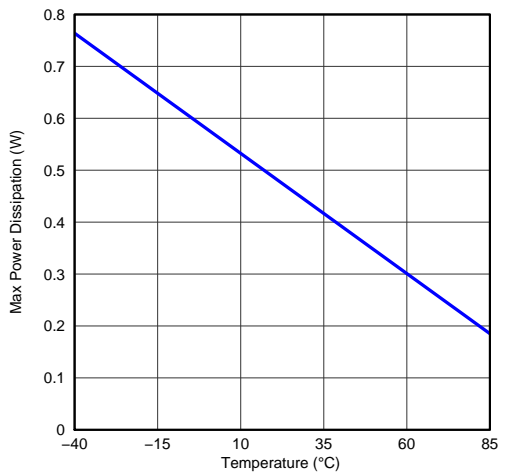

Figure 7. Allowable Power Dissipation

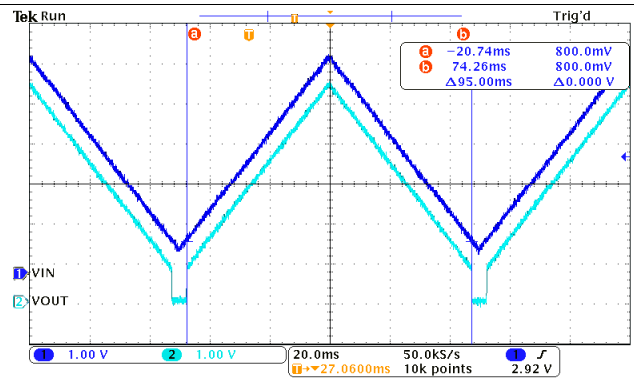

Figure 8. Under-Voltage Lockout Response (IOUT = -100mA)

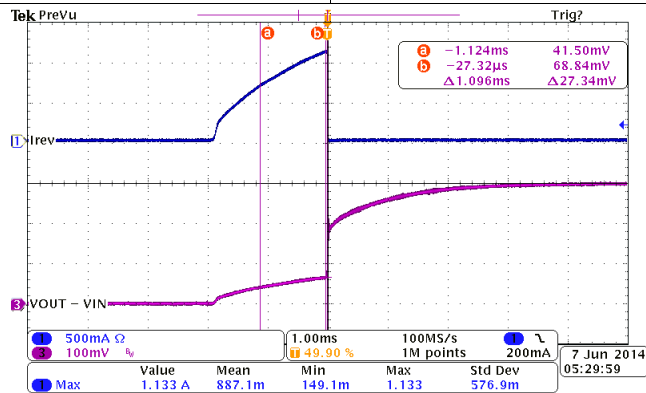

Figure 9. Reverse Current Protection (VIN = 3.0 V, VOUT Ramp up From 3.0 V to 3.3 V)

7.7.1 Typical AC Characteristics

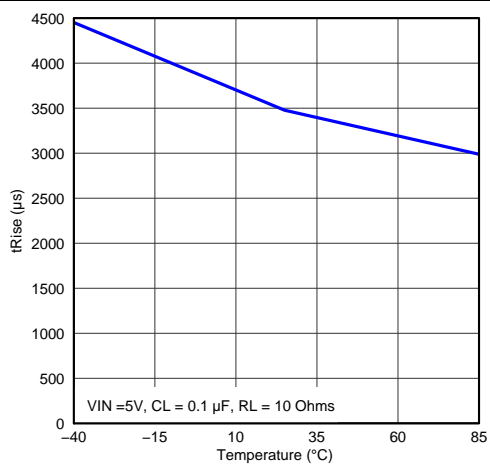

Figure 10. Rise Time vs Temperature

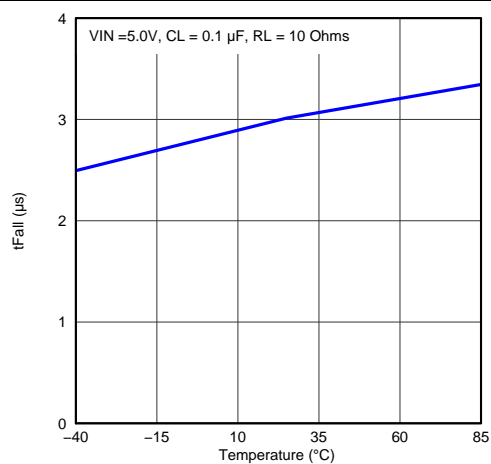

Figure 11. Fall Time vs Temperature

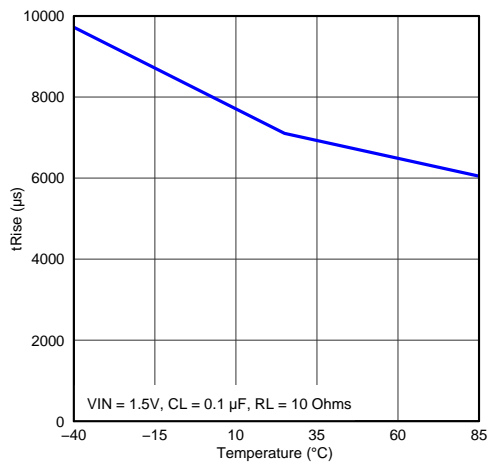

Figure 12. Rise Time vs Temperature

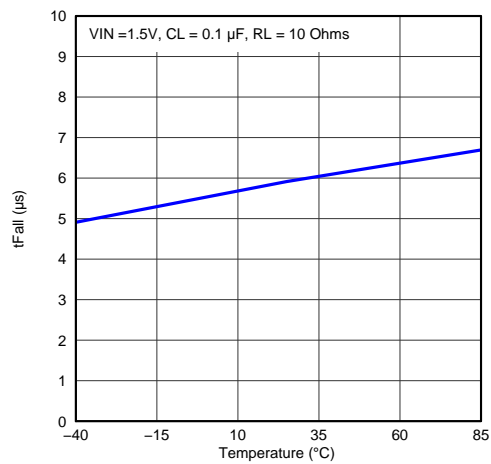

Figure 13. Fall Time vs Temperature

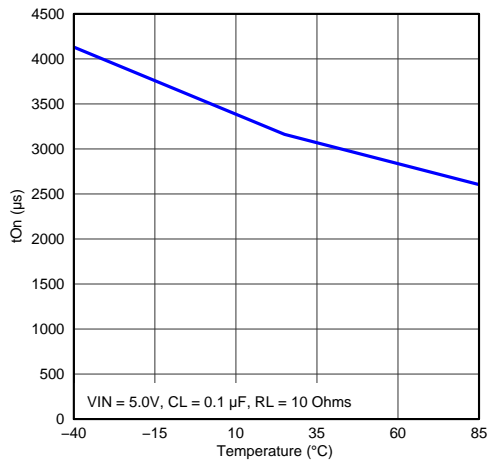

Figure 14. Turn-On Time vs Temperature

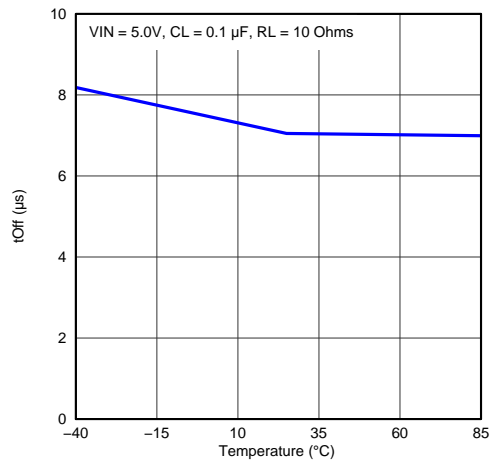
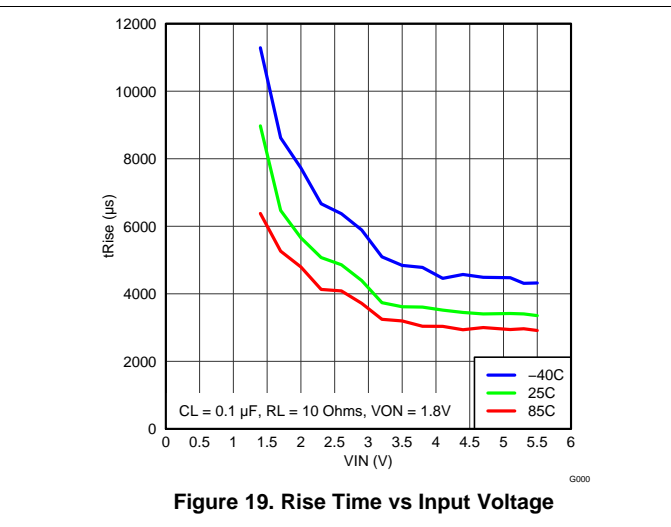
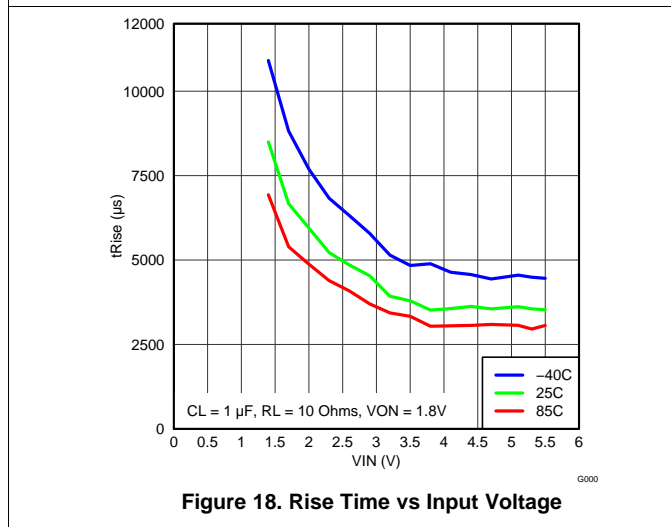
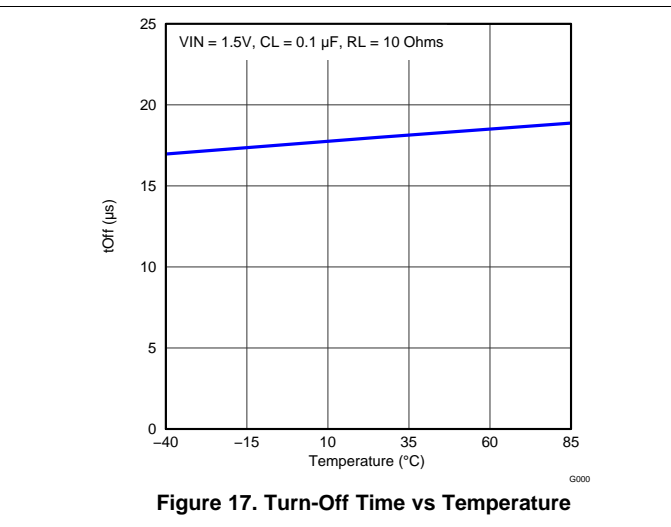
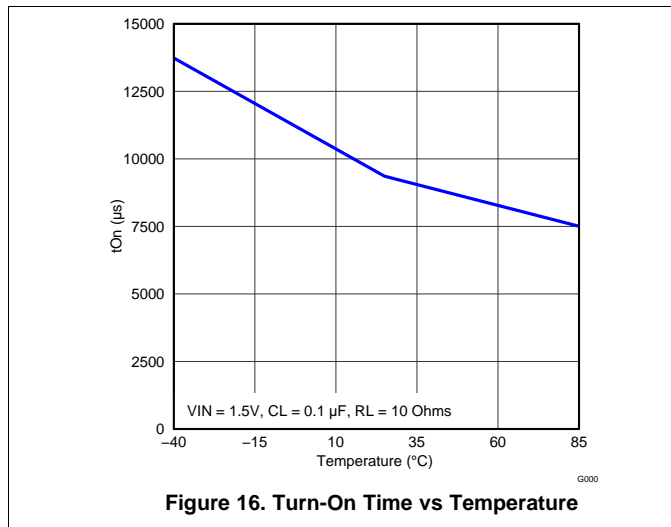
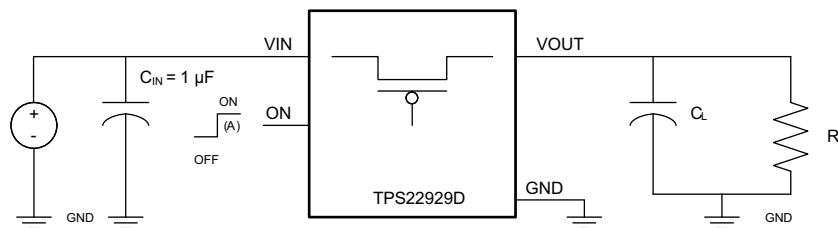

Figure 15. Turn-Off Time vs Temperature

Typical AC Characteristics (continued)



8 Parametric Measurement Information



A. Rise and fall times of the control signal is 100 ns.

Figure 20. Test Circuit

Parametric Measurement Information (continued)

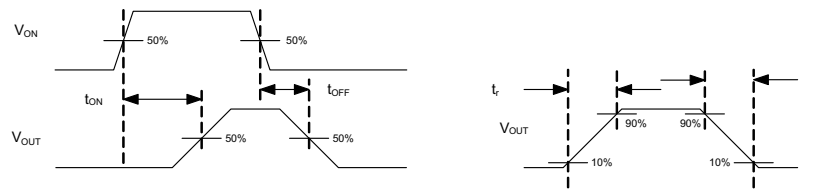

Figure 21. T_{ON}/T_{OFF} Waveforms

9 Detailed Description

9.1 Overview

The TPS22929D is a single channel, 1.8-A load switch in a small, space-saving 6-pin SOT23-6 package. This device implements a low resistance P-channel MOSFET with a controlled rise time for applications that need to limit the inrush current.

This device is also designed to have very low leakage current during off state. This prevents downstream circuits from pulling high standby current from the supply. Integrated control logic, driver, power supply, and output discharge FET eliminates the need for additional external components, which reduces solution size and bill of materials (BOM) count.

9.2 Functional Block Diagram

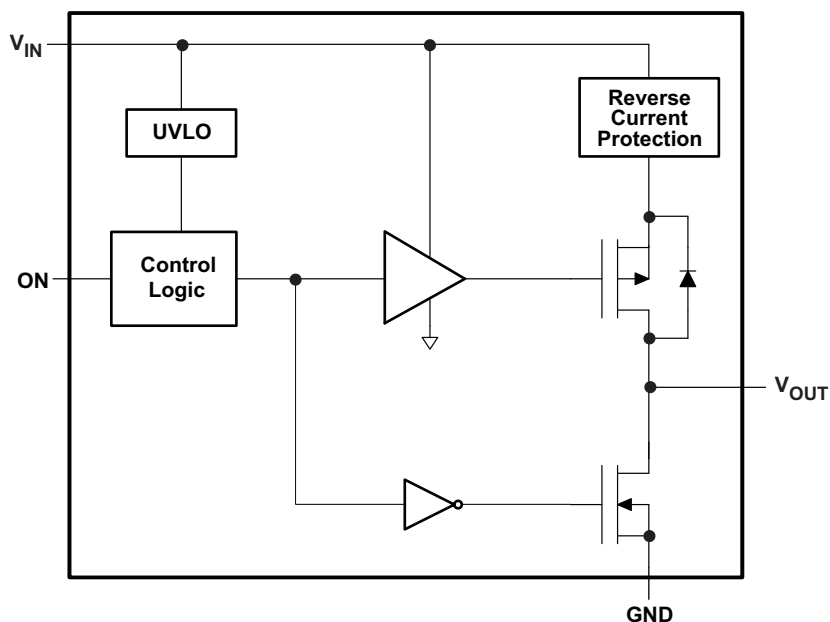

9.3 Feature Description

9.3.1 On/Off Control

The ON pin controls the state of the switch. Asserting ON high enables the switch. ON is active high and has a low threshold, making it capable of interfacing with low-voltage signals. The ON pin is compatible with standard GPIO logic threshold. It can be used with any microcontroller with 1.2-V, 1.8-V, 2.5-V or 3.3-V GPIOs.

9.3.2 Output Pull-Down

The output pull-down is active when the user is turning off the main pass FET. The pull-down discharges the output rail to approximately 10% of the rail, and then the output pull-down is automatically disconnected to optimize the shutdown current.

9.3.3 Under-Voltage Lockout

The under-voltage lockout turns-off the switch if the input voltage drops below the under-voltage lockout threshold. During under-voltage lockout (UVLO), if the voltage level at V_{OUT} exceeds the voltage level at V_{IN} by the Reverse Current Voltage Threshold (V_{RVP}), the body diode will be disengaged to prevent any current flow to V_{IN} . With the ON pin active the input voltage rising above the under-voltage lockout threshold will cause a controlled turn-on of the switch which limits current over-shoots.

Feature Description (continued)

9.3.4 Reverse Current Protection

In a scenario where V_{OUT} is greater than V_{IN} , there is potential for reverse current through the pass FET or the body diode. The TPS22929D monitors V_{IN} and V_{OUT} voltage levels. When the reverse current voltage threshold (V_{RVP}) is exceeded, the switch is disabled (within 10 μ s typ). Additionally, the body diode is disengaged so as to prevent any reverse current flow to V_{IN} . The FET, and the output (V_{OUT}), will resume normal operation when the reverse voltage scenario is no longer present.

Use the following formula to calculate the amount of reverse current required to activate the protection circuit for a particular application:

$$I_{RC} = \frac{0.077V}{R_{ON(VIN)}}$$

Where,

I_{RC} is the amount of reverse current,

$R_{ON(VIN)}$ is the on-resistance as determined by the input voltage.

9.4 Device Functional Modes

Table 1. Function Table

ON	VIN to VOUT	VOUT to GND ⁽¹⁾
L	OFF	ON
H	ON	OFF

(1) See [Output Pull-Down](#) section.

10 Application and Implementation

10.1 Application Information

10.1.1 VIN to VOUT Voltage Drop

The VIN to VOUT voltage drop in the device is determined by the R_{ON} of the device and the load current. The R_{ON} of the device depends upon the VIN condition of the device. Refer to the R_{ON} specification of the device in the Electrical Characteristics table of this datasheet. Once the R_{ON} of the device is determined based upon the VIN conditions, use [Equation 1](#) to calculate the VIN to VOUT voltage drop:

$$\Delta V = I_{LOAD} \times R_{ON} \quad (1)$$

Where,

ΔV = Voltage drop from VIN to VOUT

I_{LOAD} = Load current

R_{ON} = On-resistance of the device for a specific V_{IN}

An appropriate I_{LOAD} must be chosen such that the I_{MAX} specification of the device is not violated.

10.1.2 Input Capacitor

To limit the voltage drop on the input supply caused by transient inrush currents, when the switch turns on into a discharged load capacitor or short-circuit, a capacitor needs to be placed between VIN and GND. A 1- μ F ceramic capacitor, C_{IN} , placed close to the pins is usually sufficient. Higher values of C_{IN} can be used to further reduce the voltage drop.

10.1.3 Output Capacitor

A C_{IN} to C_L ratio of 10 to 1 is recommended for minimizing V_{IN} dip caused by inrush currents during startup.

10.2 Typical Application

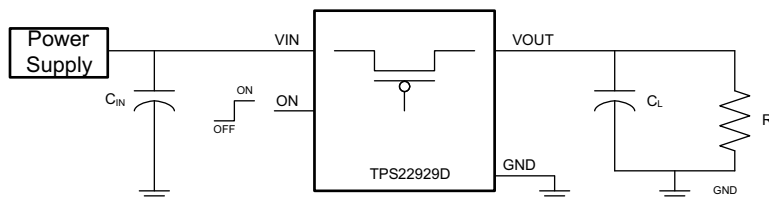

Figure 22. Typical Application Schematic

10.2.1 Design Requirements

Design Parameter	Example Value
VIN	1.5 V to 5 V
CL	0.1 μ F to 1 μ F
Maximum Acceptable Inrush Current	10 mA

10.2.2 Detailed Design Procedure

10.2.2.1 Managing Inrush Current

When the switch is enabled, the output capacitors must be charged up from 0-V to VIN voltage. This charge arrives in the form of inrush current. Inrush current can be calculated using the following equation:

$$\text{Inrush Current} = C \times \frac{dv}{dt} \quad (2)$$

Where,

C = Output capacitance

$\frac{dv}{dt}$ = Output slew rate

The TPS22929D offers a very slow controlled rise time for minimizing inrush current. This device can be selected based upon the maximum acceptable slew rate which can be calculated using the design requirements and the inrush current equation. An output capacitance of 1.0 μF will be used since the amount of inrush increases with output capacitance:

$$10 \text{ mA} = 1.0 \mu\text{F} \times \frac{dv}{dt} \quad (3)$$

$$\frac{dv}{dt} = 10 \text{ V/ms} \quad (4)$$

To ensure an inrush current of less than 10 mA, a device with a slew rate less than 10 V/ms must be used.

The TPS22929D has a typical rise time of 4500 μs at 3.3 V . This results in a slew rate of 733 mV/ms which meets the above design requirements.

10.2.3 Application Curves

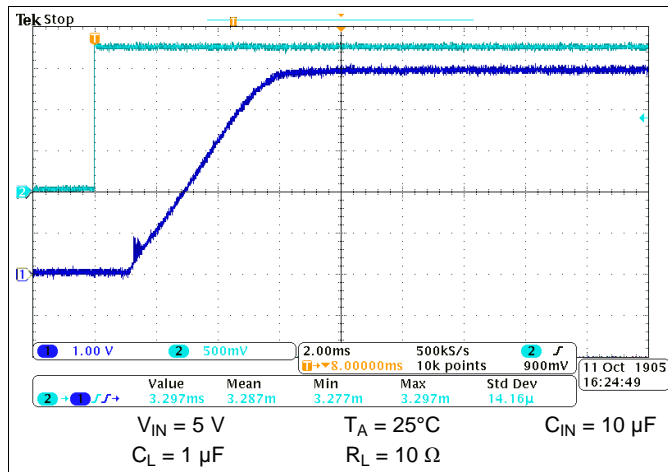

Figure 23. Turn-On Response

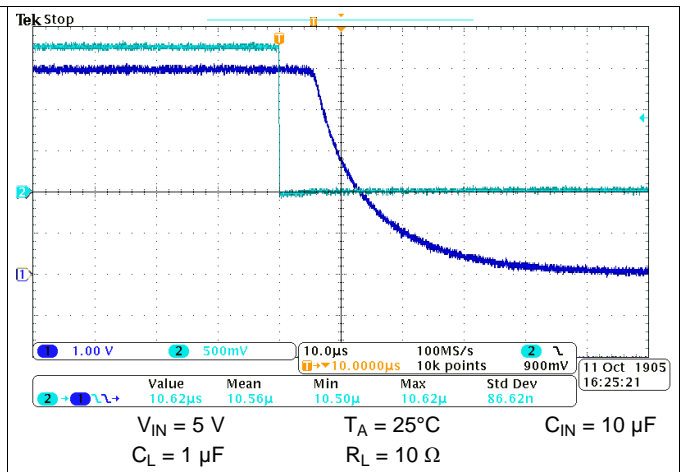

Figure 24. Turn-Off Response

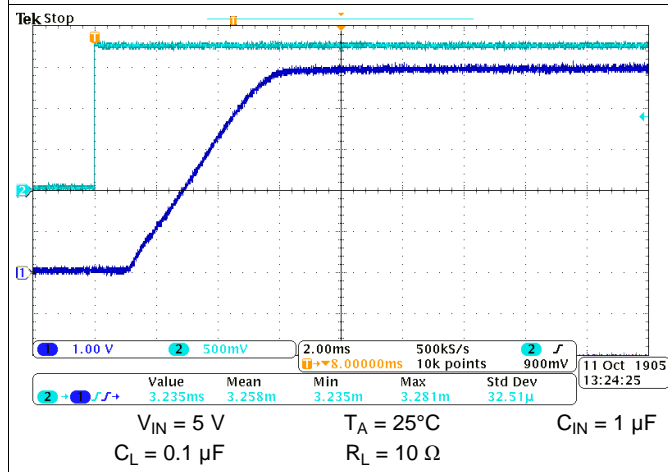

Figure 25. Turn-On Response Time

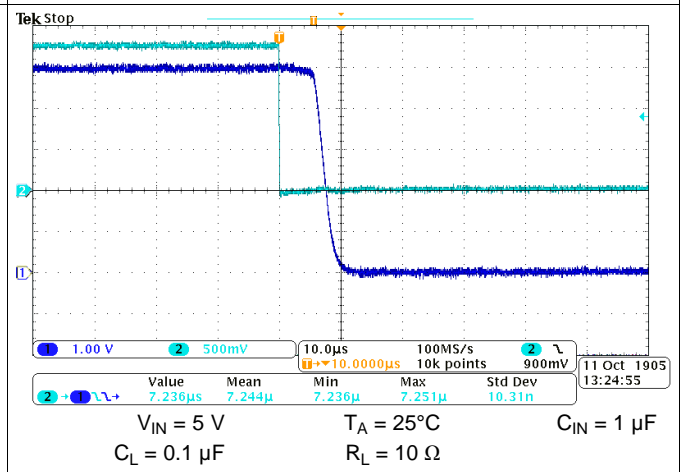

Figure 26. Turn-Off Response Time

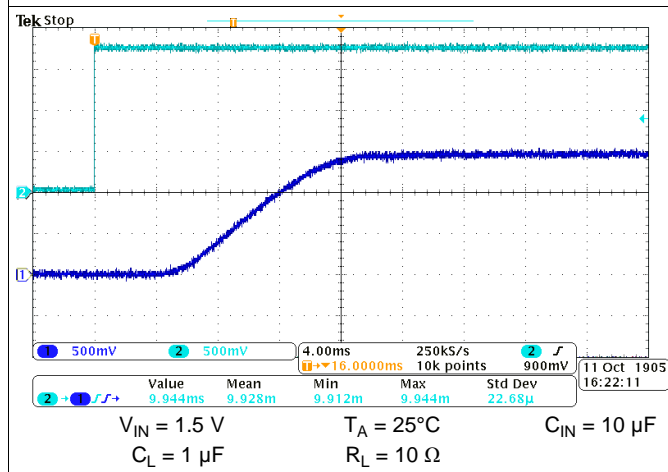

Figure 27. Turn-On Response Time

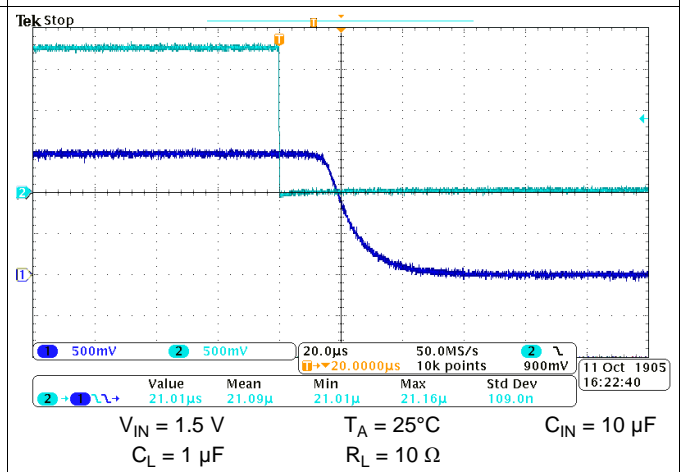
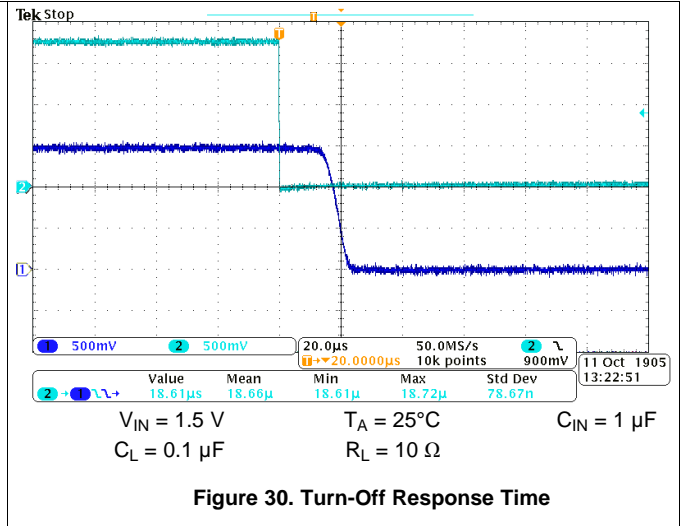
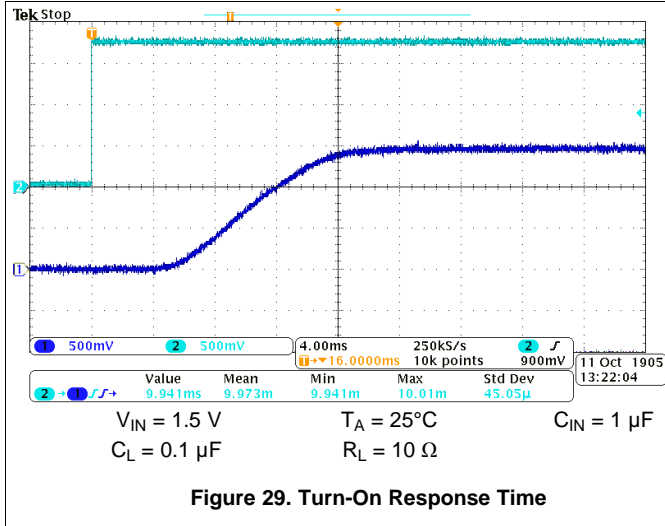

Figure 28. Turn-Off Response Time



11 Power Supply Recommendations

The device is designed to operate with a V_{IN} range of 1.4 V to 5.5 V.

12 Layout

12.1 Layout Guidelines

For best performance, all traces should be as short as possible. To be most effective, the input and output capacitors should be placed close to the device to minimize the effects that parasitic trace inductances may have on normal operation. Using wide traces for V_{IN} , V_{OUT} , and GND helps minimize the parasitic electrical effects along with minimizing the case to ambient thermal impedance.

12.1.1 Thermal Considerations

For best device performance, be sure to follow the thermal guidelines in the [Thermal Information](#) table. To calculate max allowable continuous current for your application for a specific V_{IN} and ambient temperature, use the following formula:

$$I_{MAX} = \sqrt{\frac{T_J - T_A}{\theta_{JA} R_{ON}}}$$

Where:

I_{MAX} = Max allowable continuous current

T_J = Max thermal junction temperature (125°C)

T_A = Ambient temperature of the application

θ_{JA} = Junction-to-air thermal impedance (216°C/W)

R_{ON} = R_{ON} at a specified input voltage V_{IN} (see [Electrical Characteristics](#))

12.2 Layout Example

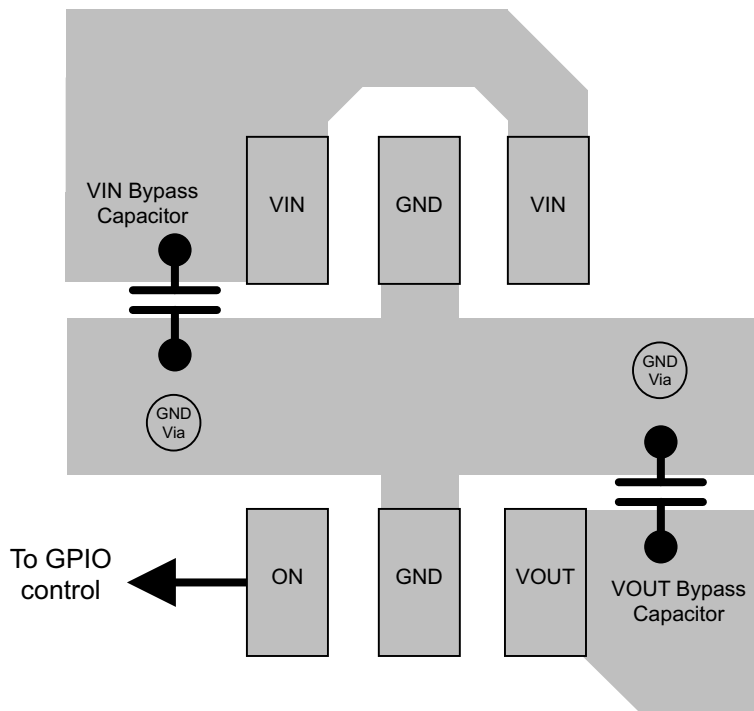

Figure 31. Layout Drawing

13 器件和文档支持

13.1 商标

All trademarks are the property of their respective owners.

13.2 静电放电警告



这些装置包含有限的内置 ESD 保护。存储或装卸时，应将导线一起截短或将装置放置于导电泡棉中，以防止 MOS 门极遭受静电损伤。

13.3 术语表

[SLYZ022](#) — TI 术语表。

这份术语表列出并解释术语、首字母缩略词和定义。

14 机械、封装和可订购信息

以下页中包括机械、封装和可订购信息。这些信息是针对指定器件可提供的最新数据。这些数据会在无通知且不对本文档进行修订的情况下发生改变。要获得这份数据表的浏览器版本，请查阅左侧的导航栏。

PACKAGING INFORMATION

Orderable Device	Status (1)	Package Type	Package Drawing	Pins	Package Qty	Eco Plan (2)	Lead finish/ Ball material (6)	MSL Peak Temp (3)	Op Temp (°C)	Device Marking (4/5)	Samples
TPS22929DDBVR	ACTIVE	SOT-23	DBV	6	3000	RoHS & Green	NIPDAU	Level-1-260C-UNLIM	-40 to 85	(NF4F, NF4W)	Samples
TPS22929DDBVT	ACTIVE	SOT-23	DBV	6	250	RoHS & Green	NIPDAU	Level-1-260C-UNLIM	-40 to 85	(NF4F, NF4W)	Samples

(1) The marketing status values are defined as follows:

ACTIVE: Product device recommended for new designs.

LIFEBUY: TI has announced that the device will be discontinued, and a lifetime-buy period is in effect.

NRND: Not recommended for new designs. Device is in production to support existing customers, but TI does not recommend using this part in a new design.

PREVIEW: Device has been announced but is not in production. Samples may or may not be available.

OBSOLETE: TI has discontinued the production of the device.

(2) **RoHS:** TI defines "RoHS" to mean semiconductor products that are compliant with the current EU RoHS requirements for all 10 RoHS substances, including the requirement that RoHS substance do not exceed 0.1% by weight in homogeneous materials. Where designed to be soldered at high temperatures, "RoHS" products are suitable for use in specified lead-free processes. TI may reference these types of products as "Pb-Free".

RoHS Exempt: TI defines "RoHS Exempt" to mean products that contain lead but are compliant with EU RoHS pursuant to a specific EU RoHS exemption.

Green: TI defines "Green" to mean the content of Chlorine (Cl) and Bromine (Br) based flame retardants meet JS709B low halogen requirements of <=1000ppm threshold. Antimony trioxide based flame retardants must also meet the <=1000ppm threshold requirement.

(3) MSL, Peak Temp. - The Moisture Sensitivity Level rating according to the JEDEC industry standard classifications, and peak solder temperature.

(4) There may be additional marking, which relates to the logo, the lot trace code information, or the environmental category on the device.

(5) Multiple Device Markings will be inside parentheses. Only one Device Marking contained in parentheses and separated by a "~" will appear on a device. If a line is indented then it is a continuation of the previous line and the two combined represent the entire Device Marking for that device.

(6) Lead finish/Ball material - Orderable Devices may have multiple material finish options. Finish options are separated by a vertical ruled line. Lead finish/Ball material values may wrap to two lines if the finish value exceeds the maximum column width.

Important Information and Disclaimer:The information provided on this page represents TI's knowledge and belief as of the date that it is provided. TI bases its knowledge and belief on information provided by third parties, and makes no representation or warranty as to the accuracy of such information. Efforts are underway to better integrate information from third parties. TI has taken and continues to take reasonable steps to provide representative and accurate information but may not have conducted destructive testing or chemical analysis on incoming materials and chemicals. TI and TI suppliers consider certain information to be proprietary, and thus CAS numbers and other limited information may not be available for release.

In no event shall TI's liability arising out of such information exceed the total purchase price of the TI part(s) at issue in this document sold by TI to Customer on an annual basis.

TAPE AND REEL INFORMATION



QUADRANT ASSIGNMENTS FOR PIN 1 ORIENTATION IN TAPE



*All dimensions are nominal

Device	Package Type	Package Drawing	Pins	SPQ	Reel Diameter (mm)	Reel Width W1 (mm)	A0 (mm)	B0 (mm)	K0 (mm)	P1 (mm)	W (mm)	Pin1 Quadrant
TPS22929DDBVR	SOT-23	DBV	6	3000	178.0	9.0	3.23	3.17	1.37	4.0	8.0	Q3
TPS22929DDBVT	SOT-23	DBV	6	250	178.0	9.0	3.23	3.17	1.37	4.0	8.0	Q3

TAPE AND REEL BOX DIMENSIONS

*All dimensions are nominal

Device	Package Type	Package Drawing	Pins	SPQ	Length (mm)	Width (mm)	Height (mm)
TPS22929DDBVR	SOT-23	DBV	6	3000	180.0	180.0	18.0
TPS22929DDBVT	SOT-23	DBV	6	250	180.0	180.0	18.0

DBV0006A



PACKAGE OUTLINE

SOT-23 - 1.45 mm max height

SMALL OUTLINE TRANSISTOR



4214840/C 06/2021

NOTES:

1. All linear dimensions are in millimeters. Any dimensions in parenthesis are for reference only. Dimensioning and tolerancing per ASME Y14.5M.
2. This drawing is subject to change without notice.
3. Body dimensions do not include mold flash or protrusion. Mold flash and protrusion shall not exceed 0.25 per side.
4. Leads 1,2,3 may be wider than leads 4,5,6 for package orientation.
5. Reference JEDEC MO-178.

EXAMPLE BOARD LAYOUT

DBV0006A

SOT-23 - 1.45 mm max height

SMALL OUTLINE TRANSISTOR



LAND PATTERN EXAMPLE
EXPOSED METAL SHOWN
SCALE:15X

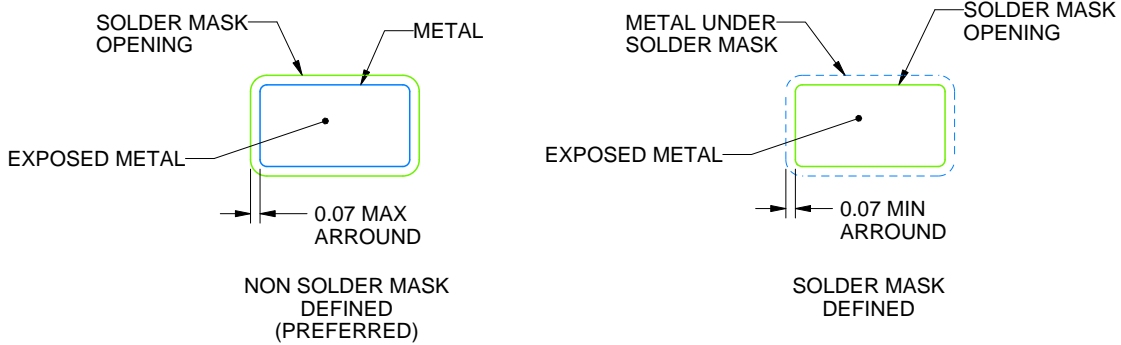

SOLDER MASK DETAILS

4214840/C 06/2021

NOTES: (continued)

- 6. Publication IPC-7351 may have alternate designs.
- 7. Solder mask tolerances between and around signal pads can vary based on board fabrication site.

EXAMPLE STENCIL DESIGN

DBV0006A

SOT-23 - 1.45 mm max height

SMALL OUTLINE TRANSISTOR



SOLDER PASTE EXAMPLE
BASED ON 0.125 mm THICK STENCIL
SCALE:15X

4214840/C 06/2021

NOTES: (continued)

8. Laser cutting apertures with trapezoidal walls and rounded corners may offer better paste release. IPC-7525 may have alternate design recommendations.
9. Board assembly site may have different recommendations for stencil design.

重要声明和免责声明

TI 提供技术和可靠性数据（包括数据表）、设计资源（包括参考设计）、应用或其他设计建议、网络工具、安全信息和其他资源，不保证没有瑕疵且不做任何明示或暗示的担保，包括但不限于对适销性、某特定用途方面的适用性或不侵犯任何第三方知识产权的暗示担保。

这些资源可供使用 TI 产品进行设计的熟练开发人员使用。您将自行承担以下全部责任：(1) 针对您的应用选择合适的 TI 产品，(2) 设计、验证并测试您的应用，(3) 确保您的应用满足相应标准以及任何其他安全、安保或其他要求。这些资源如有变更，恕不另行通知。TI 授权您仅可将这些资源用于研发本资源所述的 TI 产品的应用。严禁对这些资源进行其他复制或展示。您无权使用任何其他 TI 知识产权或任何第三方知识产权。您应全额赔偿因在这些资源的使用中对 TI 及其代表造成的任何索赔、损害、成本、损失和债务，TI 对此概不负责。

TI 提供的产品受 TI 的销售条款 (<https://www.ti.com.cn/zh-cn/legal/termsofsale.html>) 或 [ti.com.cn](https://www.ti.com.cn) 上其他适用条款/TI 产品随附的其他适用条款的约束。TI 提供这些资源并不会扩展或以其他方式更改 TI 针对 TI 产品发布的适用的担保或担保免责声明。

邮寄地址：上海市浦东新区世纪大道 1568 号中建大厦 32 楼，邮政编码：200122

Copyright © 2021 德州仪器半导体技术（上海）有限公司