

TPS7A74 具有可编程软启动功能的 1.5A 低压降线性稳压器

1 特性

- V_{OUT} 范围：0.65V 至 3.6V
- 超低 V_{IN} 范围：0.65 V 至 6 V
- V_{BIAS} 范围：1.7 V 至 6 V
- 低压降：1.5A、 $V_{BIAS} = 5V$ 下的典型值为 150 mV
- 噪声：7.1 μV_{RMS}
- PSRR：
 - 1kHz 时为 70dB
 - 10 kHz 时为 60dB
 - 100 kHz 时为 55dB
 - 在 1MHz 时为 50dB
- 线路、负载和温度范围内的精度为 1.5%
- 可编程软启动可提供线性电压启动
- V_{BIAS} 支持低 V_{IN} 运行，具有良好的瞬态响应
- IN 和 BIAS 上都有 UVLO
- 与 $\geq 10 \mu F$ 的任何输出电容器一起工作时可保持稳定
- 封装：小型 3mm × 3mm × 0.8mm WSON-8

2 应用

- 高性能计算
- 微服务器
- 台式计算机和 PC 主板
- 数据集中器
- 耐用型 PC 笔记本电脑

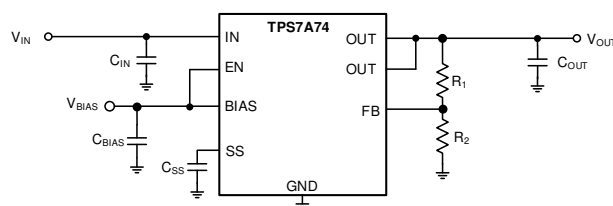

典型应用电路 (可调节)

3 说明

TPS7A74 低压降 (LDO) 线性稳压器可面向多种应用提供易于使用的稳健型电源管理解决方案。用户可编程软启动通过减少启动时的电容涌入电流，更大限度地减少了输入电源上的应力。软启动具有单调性，非常适合为各类处理器和专用集成电路 (ASIC) 供电。借助使能输入，可通过外部稳压器轻松实现时序控制。凭借全方位的灵活性，该器件可为现场可编程门阵列 (FPGA)、数字信号处理器 (DSP) 等具有特殊启动要求的应用配置可满足其时序要求的解决方案。

该器件还具有高精度的参考电压电路和误差放大器，可在整个负载、线路、温度和过程范围内提供 1.5% 精度。该器件在使用大于或等于 10 μF 的任何类型的电容器时都能保持稳定运行，并具有 $T_J = -40^\circ C$ 至 $+125^\circ C$ 的额定结温范围。TPS7A74 采用小型 3mm × 3mm WSON-8 封装，可实现高度紧凑的总体解决方案尺寸。

封装信息⁽¹⁾

器件型号	封装	封装尺寸 (标称值)
TPS7A74	WSON (8)	3.00mm × 3.00mm

(1) 如需了解所有可用封装，请参阅数据表末尾的可订购产品附录。

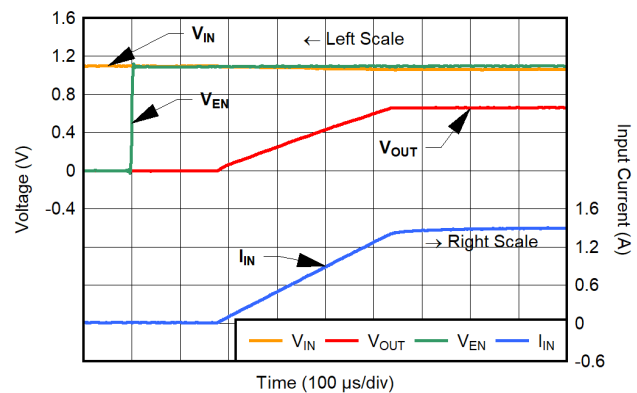

带载启动



Table of Contents

1 特性	1	7.5 Programming.....	23
2 应用	1	8 Application and Implementation	25
3 说明	1	8.1 Application Information.....	25
4 Revision History	2	8.2 Typical Application.....	29
5 Pin Configuration and Functions	3	8.3 Power Supply Recommendations.....	30
6 Specifications	4	8.4 Layout.....	31
6.1 Absolute Maximum Ratings.....	4	9 Device and Documentation Support	33
6.2 ESD Ratings.....	4	9.1 Device Support.....	33
6.3 Recommended Operating Conditions.....	5	9.2 Documentation Support.....	33
6.4 Thermal Information.....	5	9.3 接收文档更新通知.....	33
6.5 Electrical Characteristics.....	5	9.4 支持资源.....	33
6.6 Typical Characteristics.....	7	9.5 Trademarks.....	33
7 Detailed Description	18	9.6 Electrostatic Discharge Caution.....	33
7.1 Overview.....	18	9.7 术语表.....	33
7.2 Functional Block Diagram.....	18	10 Mechanical, Packaging, and Orderable	
7.3 Feature Description.....	19	Information	34
7.4 Device Functional Modes.....	22		

4 Revision History

注：以前版本的页码可能与当前版本的页码不同

Changes from Revision A (July 2022) to Revision B (August 2022)	Page
• Changed Minimum startup time parameters limit values.....	5

Changes from Revision * (May 2022) to Revision A (July 2022)	Page
• 将文档状态从 <i>预告信息</i> 更改为 <i>量产数据</i>	1

5 Pin Configuration and Functions



图 5-1. DSD Package, 8-Pin WSON With Thermal Pad (Top View)

Pin Functions

PIN		TYPE	DESCRIPTION
NO.	NAME		
1	BIAS	I	Bias input voltage for error amplifier, reference, and internal control circuits. Use a 0.1 μF or larger input capacitor for optimal performance. If IN is connected to BIAS, a 4.7 μF or larger capacitor must be used.
2	EN	I	Enable pin.
3	SS	I	Soft-start pin. This pin must be connected to a capacitor to GND.
4	IN	I	Input to the device. Use a 1 μF or larger input capacitor for optimal performance.
5, 6	OUT	O	Regulated output voltage. A small capacitor (total typical capacitance of $\geq 10 \mu\text{F}$, ceramic) is required from this pin to ground to assure stability.
7	FB	I	Feedback pin. The feedback connection to the center tap of an external resistor divider network that sets the output voltage. This pin must not be left floating.
8	GND	—	Ground.
—	Thermal Pad	—	Ground.

6 Specifications

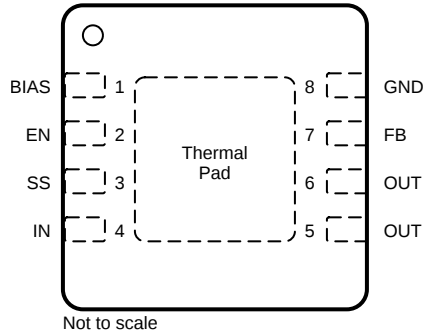
6.1 Absolute Maximum Ratings

over operating temperature range (unless otherwise noted)⁽¹⁾

		MIN	MAX	UNIT
Input voltage	IN	- 0.3	6.5	V
Bias voltage	BIAS	- 0.3	6.5	V
Enable voltage	EN	- 0.3	6.5	V
Soft-start voltage	SS	- 0.3	6.5	V
Feedback voltage	FB	- 0.3	2	V
Output voltage	OUT	- 0.3	$V_{IN} + 0.3$	V
Maximum output current	I_{LIMIT}	Internally limited		
Output short-circuit duration	I_{SC}	Indefinite		
Continuous total power dissipation	P_{DISS}	See Thermal Information		
Junction Temperature	T_J	- 40	150	°C
Storage Temperature	T_{stg}	- 55	150	

- (1) Operation outside the Absolute Maximum Ratings may cause permanent device damage. Absolute Maximum Ratings do not imply functional operation of the device at these or any other conditions beyond those listed under Recommended Operating Conditions. If used outside the Recommended Operating Conditions but within the Absolute Maximum Ratings, the device may not be fully functional, and this may affect device reliability, functionality, performance, and shorten the device lifetime.

6.2 ESD Ratings

			VALUE	UNIT
$V_{(ESD)}$	Electrostatic discharge	Human body model (HBM), per ANSI/ESDA/JEDEC JS-001, all pins ⁽¹⁾	±2000	V
		Charged device model (CDM), per JEDEC specification JESD22-C101, all pins ⁽²⁾	±500	

- (1) JEDEC document JEP155 states that 500-V HBM allows safe manufacturing with a standard ESD control process.
 (2) JEDEC document JEP157 states that 250-V CDM allows safe manufacturing with a standard ESD control process.

6.3 Recommended Operating Conditions

over operating free-air temperature range (unless otherwise noted)

		MIN	NOM	MAX	UNIT
V _{IN}	Input supply voltage	0.65	V _{BIAS} - 0.1		V
V _{BIAS} ⁽¹⁾	BIAS supply voltage	1.7		6	V
V _{EN}	Enable voltage			6	V
V _{OUT}	Output voltage	0.65		3.6	V
I _{OUT}	Output current	0		1.5	A
C _{OUT}	Output capacitor	10			μF
C _{IN}	Input capacitor ⁽²⁾	1			μF
C _{BIAS}	Bias capacitor	0.1	1		μF
T _J	Operating junction temperature	- 40		125	°C

(1) BIAS supply is required when V_{IN} is below V_{OUT} + 1.62 V.

(2) If V_{IN} and V_{BIAS} are connected to the same supply, the recommended minimum capacitor for the supply is 4.7 μF.

6.4 Thermal Information

THERMAL METRIC ⁽¹⁾		TPS7A74		UNIT
		DSD (WSON) ⁽²⁾	DSD (WSON) ⁽³⁾	
		10 PINS	10 PINS	
R _{θJA}	Junction-to-ambient thermal resistance	49.3	34.9	°C/W
R _{θJC(top)}	Junction-to-case (top) thermal resistance	55.3	-	°C/W
R _{θJB}	Junction-to-board thermal resistance	21.3	-	°C/W
ψ _{JT}	Junction-to-top characterization parameter	1.9	1.6	°C/W
ψ _{JB}	Junction-to-board characterization parameter	21.3	18.8	°C/W
R _{θJC(bot)}	Junction-to-case (bottom) thermal resistance	5.8	-	°C/W

(1) For more information about traditional and new thermal metrics, see the [Semiconductor and IC package thermal metrics application report](#).

(2) JEDEC standard. (2s2p, no vias to internal planes and bottom layer).

(3) TPS7A74 thermal characteristics on EVM.

6.5 Electrical Characteristics

at V_{EN} = 1.1 V, V_{IN} = V_{OUT} + 0.3 V, C_{BIAS} = 0.1 μF, C_{IN} = C_{OUT} = 10 μF, C_{NR} = 10 nF, I_{OUT} = 10 mA, V_{BIAS} = 5.0 V ⁽³⁾, and T_J = - 40°C to 125°C (unless otherwise noted); typical values are at T_J = 25°C

PARAMETER		TEST CONDITIONS	MIN	TYP	MAX	UNIT
V _{REF}	Internal reference (adj.)		0.641	0.65	0.659	V
	Output accuracy ⁽¹⁾ ⁽⁴⁾ ⁽⁵⁾	2.97 V ≤ V _{BIAS} ≤ 6 V, 0 mA ≤ I _{OUT} ≤ 1.5 A	- 1.5	±0.5	1.5	%
	Line regulation (V _{BIAS})	Max(2.7 V, V _{OUT} + 1.6 V) ≤ V _{BIAS} ≤ 6 V		0.2	0.32	%/V
	Line regulation (V _{IN})	V _{OUT(nom)} + 0.15 V ≤ V _{IN} ≤ 6 V		0.01	0.05	%/V
	Load regulation	0 mA ≤ I _{OUT} ≤ 1.5 A		0.33		%/A
V _{DO(IN)}	V _{IN} dropout voltage ⁽²⁾	I _{OUT} = 1.5 A, V _{BIAS} - V _{OUT(nom)} ≥ 2.8 V		150	180	mV
V _{DO(BIAS)}	V _{BIAS} dropout voltage ⁽²⁾	I _{OUT} = 1.5 A, V _{IN} = V _{BIAS}		1.1	1.3	V
I _{CL}	Output current limit	V _{OUT} = 80% × V _{OUT(nom)}	2	2.7	3.3	A
I _{BIAS}	BIAS pin current	I _{OUT} = 10 mA		0.25	0.33	mA
I _{SHDN}	Shutdown supply current (I _{GND})	V _{EN} ≤ 0.4 V, V _{IN} = 6 V, V _{BIAS} = 6 V		1	55	μA
I _{FB}	Feedback pin current		- 1	0.15	1	μA
V _{BIAS(UVLO)}	Bias rail UVLO rising threshold		1.04	1.4	1.65	V

6.5 Electrical Characteristics (continued)

at $V_{EN} = 1.1\text{ V}$, $V_{IN} = V_{OUT} + 0.3\text{ V}$, $C_{BIAS} = 0.1\ \mu\text{F}$, $C_{IN} = C_{OUT} = 10\ \mu\text{F}$, $C_{NR} = 10\text{ nF}$, $I_{OUT} = 10\text{ mA}$, $V_{BIAS} = 5.0\text{ V}$ ⁽³⁾, and $T_J = -40^\circ\text{C}$ to 125°C (unless otherwise noted); typical values are at $T_J = 25^\circ\text{C}$

PARAMETER		TEST CONDITIONS	MIN	TYP	MAX	UNIT
$V_{BIAS(UVLO), HYST}$	Bias rail UVLO hysteresis		0.02	0.06	0.07	V
$V_{IN(UVLO), rising}$	In rail UVLO rising threshold		0.39	0.455	0.5	V
$V_{IN(UVLO), falling}$	In rail UVLO falling threshold		0.21	0.26	0.3	V
t_{STR}	Minimum start-up time	R_{LOAD} for $I_{OUT} = 1.0\text{ A}$, $C_{SS} = \text{open}$	35		335	μs
I_{SS}	Soft-start charging current	$V_{SS} = 0\text{ V}$	8	17	31	μA
V_{SS}	Soft-start pin disable voltage	$V_{EN} = 0\text{ V}$		0	50	mV
PSRR	Power-supply rejection (V_{BIAS} to V_{OUT})	1 kHz, $I_{OUT} = 1.5\text{ A}$, $V_{IN} = 1.8\text{ V}$, $V_{OUT} = 1.5\text{ V}$		57		dB
		300 kHz, $I_{OUT} = 1.5\text{ A}$, $V_{IN} = 1.8\text{ V}$, $V_{OUT} = 1.5\text{ V}$		27		
PSRR	Power-supply rejection (V_{IN} to V_{OUT})	BW = 10 Hz to 1 MHz, $I_{OUT} = 1\text{ A}$, $V_{IN} = 2.05\text{ V}$, $V_{OUT} = 1.8\text{ V}$		27		dB
V_n	Output voltage noise	BW = 10 Hz to 100 kHz, $I_{OUT} = 1\text{ A}$, $V_{IN} = 0.95\text{ V}$, $V_{OUT} = 0.65\text{ V}$		7.1		μV_{RMS}
$V_{EN(hi)}$	Enable input high level		1.1		5.5	V
$V_{EN(lo)}$	Enable input low level		0		0.4	V
$V_{EN(hys)}$	Enable pin hysteresis			55		mV
$V_{EN(dg)}$	Enable pin deglitch time			20		μs
I_{EN}	Enable pin current	$V_{EN} = 5\text{ V}$		0.1	0.2	μA
$R_{PULLDOWN(OUT)}$	$V_{BIAS} = 5\text{ V}$, $V_{EN} = 0\text{ V}$			0.6	1	$\text{k}\Omega$
$R_{PULLDOWN(FB)}$	$V_{BIAS} = 5\text{ V}$, $V_{EN} = 0\text{ V}$			120		Ω
T_{SD}	Thermal shutdown temperature	Shutdown, temperature increasing		165		$^\circ\text{C}$
		Reset, temperature decreasing		140		

- (1) Adjustable devices tested at 0.65 V; resistor tolerance is not taken into account.
- (2) Dropout is defined as the voltage from V_{IN} to V_{OUT} when V_{OUT} is 3% below nominal.
- (3) $V_{BIAS} = V_{DO_MAX(BIAS)} + V_{OUT}$ for $V_{OUT} \geq 3.4\text{ V}$
- (4) The device is not tested under conditions where $V_{IN} > V_{OUT} + 1.65\text{ V}$ and $I_{OUT} = 1.5\text{ A}$, because the power dissipation is higher than the maximum rating of the package. Also, this accuracy specification does not apply on any application condition that exceeds the power dissipation limit of the package under test.
- (5) The device is not tested under conditions where $V_{IN} > V_{OUT} + 1.65\text{ V}$ and $I_{OUT} = 1.5\text{ A}$, because the power dissipation is higher than the maximum rating of the package. Also, this accuracy specification does not apply on any application condition that exceeds the power dissipation limit of the package under test.

6.6 Typical Characteristics

at $T_J = 25^\circ\text{C}$, $V_{IN} = V_{OUT(nom)} + 0.3\text{ V}$, $V_{BIAS} = 5\text{ V}$, $V_{EN} = V_{IN}$, $C_{IN} = 10\ \mu\text{F}$, $C_{BIAS} = 1\ \mu\text{F}$, and $C_{OUT} = 10\ \mu\text{F}$ (unless otherwise noted)

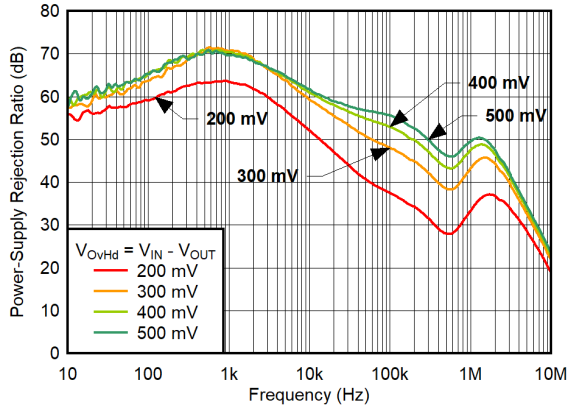

$C_{IN} = 0\ \mu\text{F}$, $C_{OUT} = 10\ \mu\text{F}$, $C_{BIAS} = 1\ \mu\text{F}$

图 6-1. PSRR vs Frequency and Overhead (OvHd) Voltage for $I_{OUT} = 400\text{ mA}$, $V_{OUT} = 1.8\text{ V}$

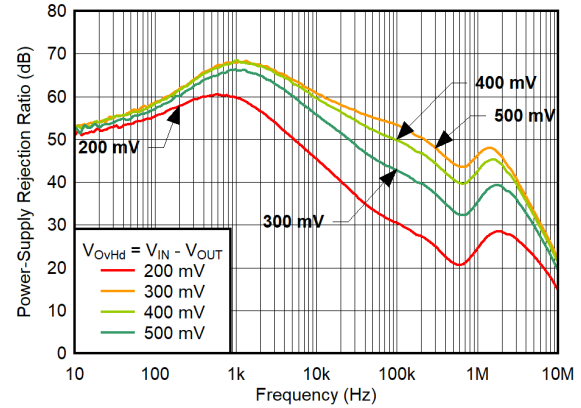

$C_{IN} = 0\ \mu\text{F}$, $C_{OUT} = 10\ \mu\text{F}$, $C_{BIAS} = 1\ \mu\text{F}$

图 6-2. PSRR vs Frequency and Overhead (OvHd) Voltage for $I_{OUT} = 750\text{ mA}$, $V_{OUT} = 1.8\text{ V}$

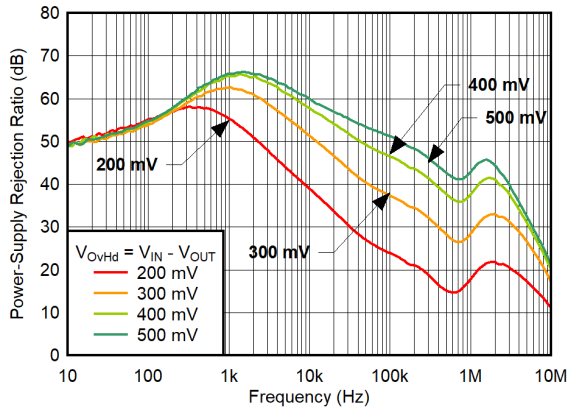

$C_{IN} = 0\ \mu\text{F}$, $C_{OUT} = 10\ \mu\text{F}$, $C_{BIAS} = 1\ \mu\text{F}$

图 6-3. PSRR vs Frequency and Overhead (OvHd) Voltage for $I_{OUT} = 1.1\text{ A}$, $V_{OUT} = 1.8\text{ V}$

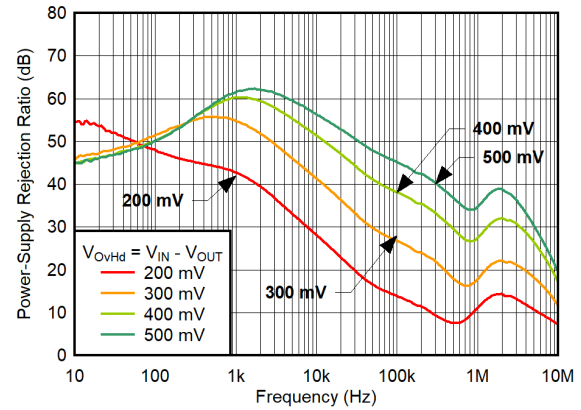

$C_{IN} = 0\ \mu\text{F}$, $C_{OUT} = 10\ \mu\text{F}$, $C_{BIAS} = 1\ \mu\text{F}$

图 6-4. PSRR vs Frequency and Overhead (OvHd) Voltage for $I_{OUT} = 1.5\text{ A}$, $V_{OUT} = 1.8\text{ V}$

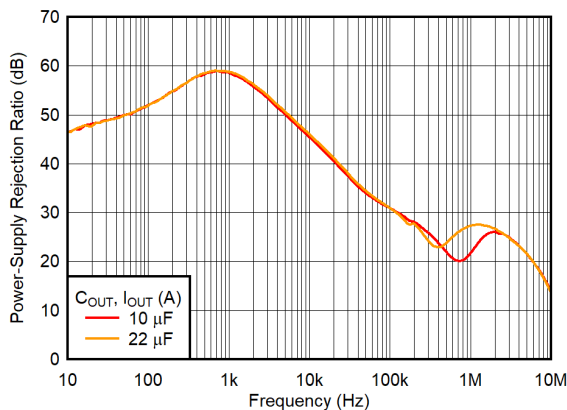

$C_{IN} = 0\ \mu\text{F}$, $C_{OUT} = 10\ \mu\text{F}$, $C_{BIAS} = 1\ \mu\text{F}$, $I_{OUT} = 1.5\text{ A}$

图 6-5. PSRR vs Frequency and C_{OUT} for $V_{OUT} = 1.8\text{ V}$

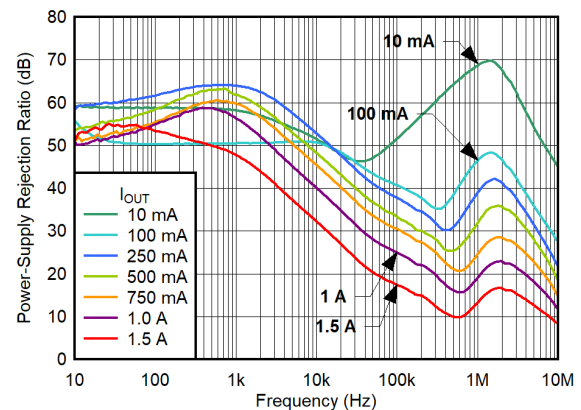

$C_{IN} = 0\ \mu\text{F}$, $C_{OUT} = 10\ \mu\text{F}$, $C_{BIAS} = 1\ \mu\text{F}$

图 6-6. PSRR vs Frequency and I_{OUT} for $V_{OvHd} = 200\text{ mV}$

6.6 Typical Characteristics (continued)

at $T_J = 25^\circ\text{C}$, $V_{IN} = V_{OUT(nom)} + 0.3\text{ V}$, $V_{BIAS} = 5\text{ V}$, $V_{EN} = V_{IN}$, $C_{IN} = 10\ \mu\text{F}$, $C_{BIAS} = 1\ \mu\text{F}$, and $C_{OUT} = 10\ \mu\text{F}$ (unless otherwise noted)

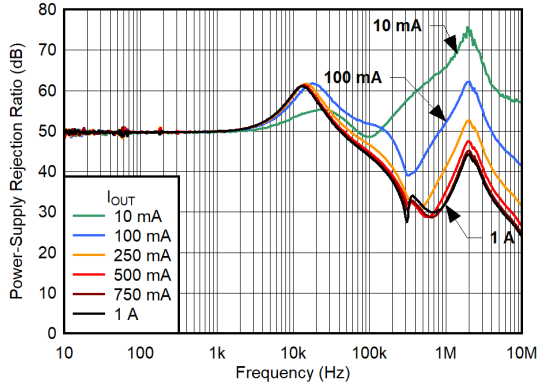

$V_{IN} = V_{OUT} + 0.3\text{ V}$, $C_{BIAS} = 0\ \mu\text{F}$, $C_{IN} = C_{OUT} = 10\ \mu\text{F}$,
 $C_{BIAS} = 1\ \mu\text{F}$

图 6-7. Bias Rail PSRR vs Frequency and I_{OUT}

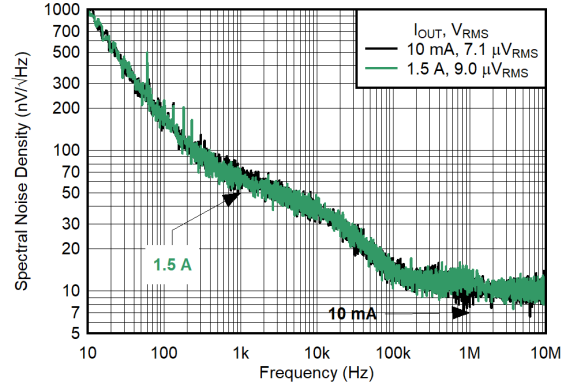

$C_{IN} = C_{OUT} = 10\ \mu\text{F}$, $C_{BIAS} = 1\ \mu\text{F}$

图 6-8. Noise vs Frequency and I_{OUT} for $V_{OUT} = 0.65\text{ V}$

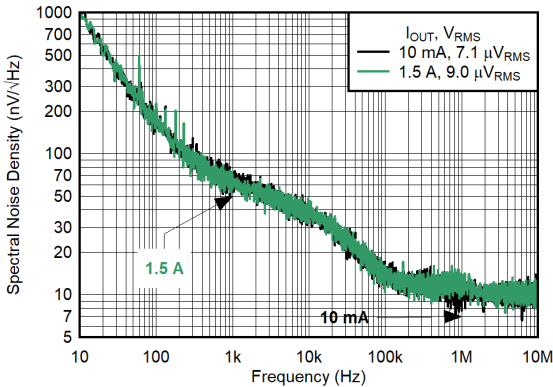

$C_{IN} = C_{OUT} = 10\ \mu\text{F}$, $C_{BIAS} = 1\ \mu\text{F}$

图 6-9. Noise vs Frequency and I_{OUT} for $V_{OUT} = 3.3\text{ V}$

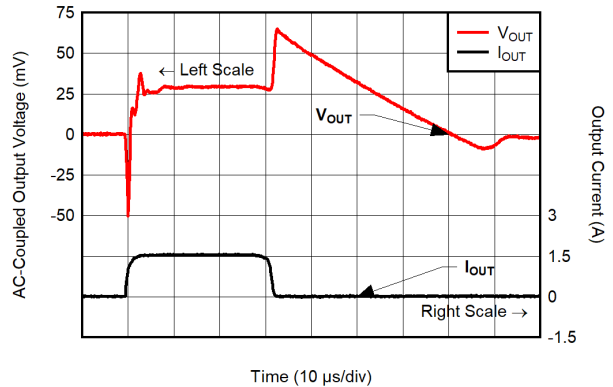

$C_{IN} = C_{OUT} = 10\ \mu\text{F}$, $C_{BIAS} = 1\ \mu\text{F}$, $I_{OUT} = 10\text{ mA to } 1.5\text{ A to } 10\text{ mA}$ at $1\text{ A}/\mu\text{s}$

图 6-10. Load Transient for $V_{OUT} = 0.65\text{ V}$

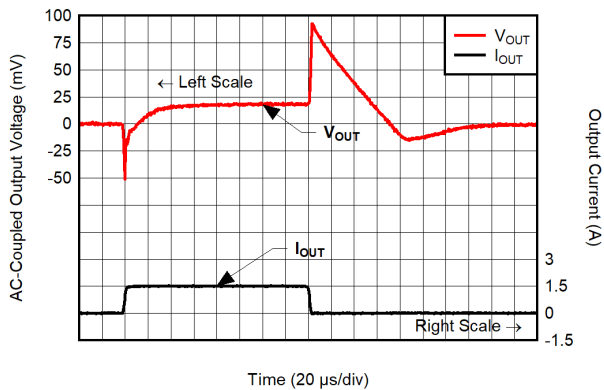

$C_{IN} = C_{OUT} = 10\ \mu\text{F}$, $C_{BIAS} = 1\ \mu\text{F}$, $I_{OUT} = 10\text{ mA to } 1.5\text{ A to } 10\text{ mA}$ at $1\text{ A}/\mu\text{s}$

图 6-11. Load Transient for $V_{OUT} = 3.3\text{ V}$

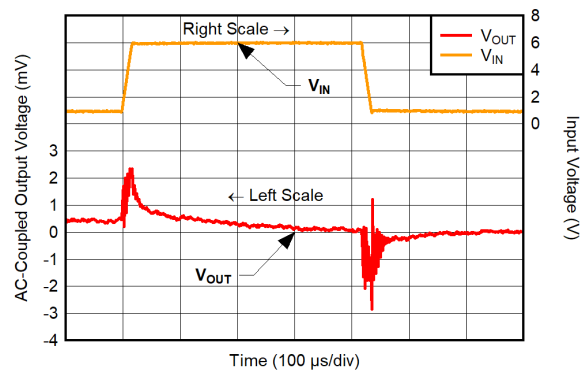

$C_{IN} = C_{OUT} = 10\ \mu\text{F}$, $C_{BIAS} = 1\ \mu\text{F}$, $I_{OUT} = 1.5\text{ A}$,
 $V_{IN} = 0.95\text{ V to } 6\text{ V to } 0.95\text{ V}$ at $1\text{ V}/\mu\text{s}$

图 6-12. Line Transient for $V_{OUT} = 0.65\text{ V}$

6.6 Typical Characteristics (continued)

at $T_J = 25^\circ\text{C}$, $V_{IN} = V_{OUT(nom)} + 0.3\text{ V}$, $V_{BIAS} = 5\text{ V}$, $V_{EN} = V_{IN}$, $C_{IN} = 10\ \mu\text{F}$, $C_{BIAS} = 1\ \mu\text{F}$, and $C_{OUT} = 10\ \mu\text{F}$ (unless otherwise noted)

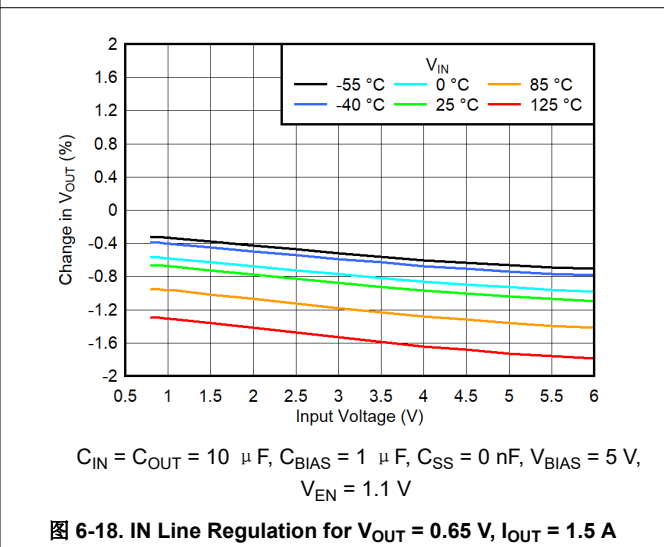
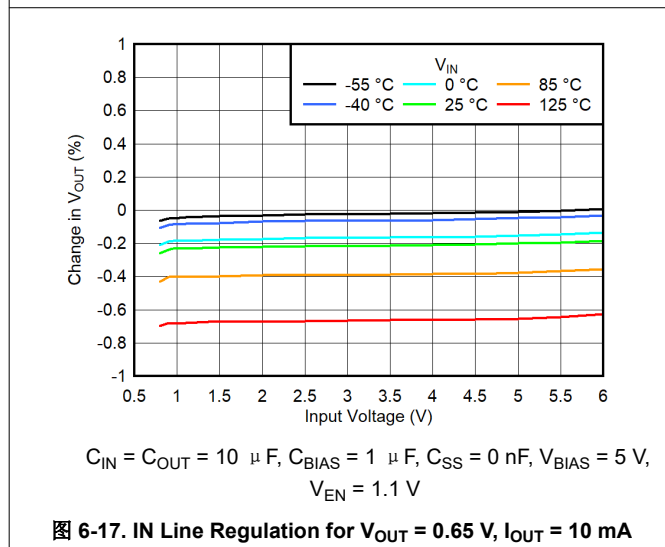
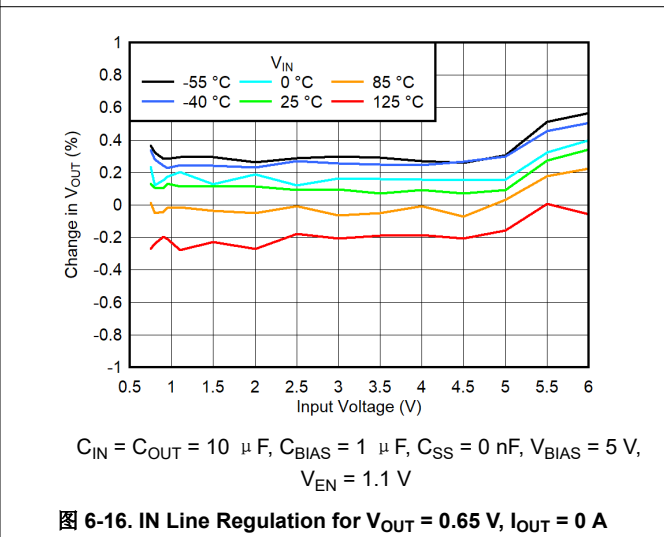
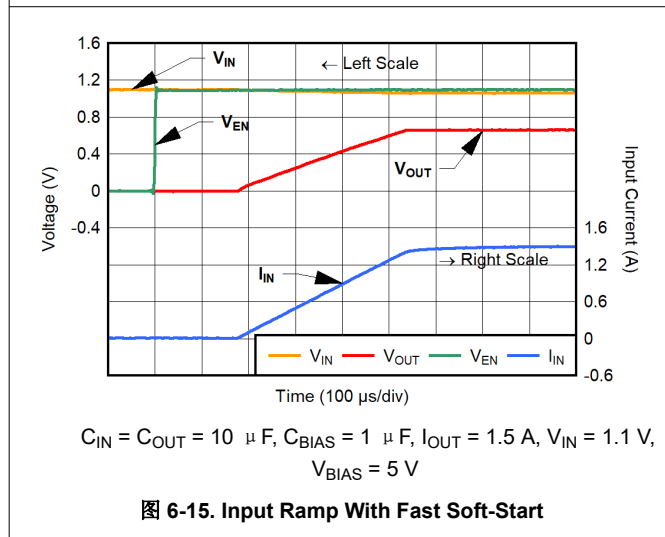
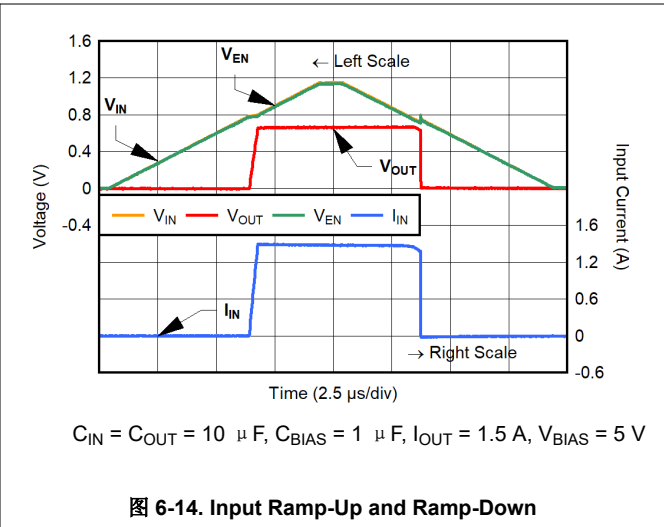
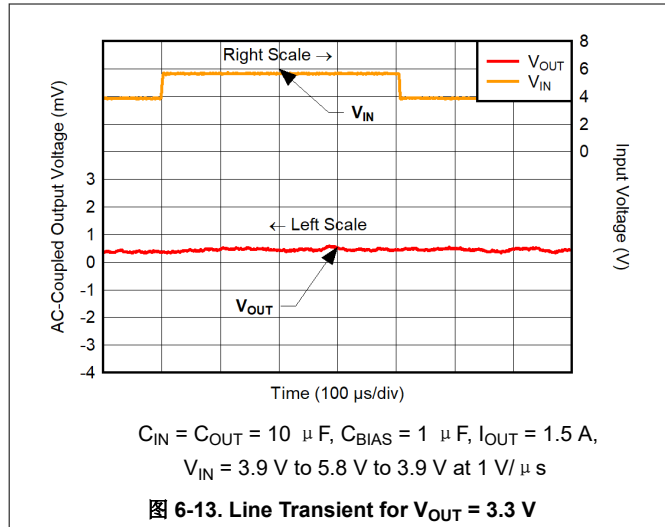

6.6 Typical Characteristics (continued)

at $T_J = 25^\circ\text{C}$, $V_{IN} = V_{OUT(nom)} + 0.3\text{ V}$, $V_{BIAS} = 5\text{ V}$, $V_{EN} = V_{IN}$, $C_{IN} = 10\ \mu\text{F}$, $C_{BIAS} = 1\ \mu\text{F}$, and $C_{OUT} = 10\ \mu\text{F}$ (unless otherwise noted)

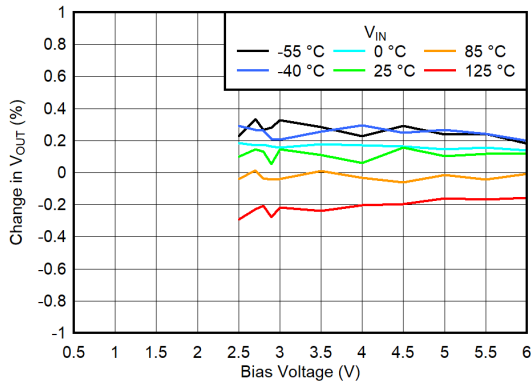

$C_{IN} = C_{OUT} = 10\ \mu\text{F}$, $C_{BIAS} = 1\ \mu\text{F}$, $C_{SS} = 0\ \text{nF}$, $V_{IN} = 0.95\text{ V}$, $V_{EN} = 1.1\text{ V}$

图 6-19. BIAS Line Regulation for $V_{OUT} = 0.65\text{ V}$, $I_{OUT} = 0\text{ A}$

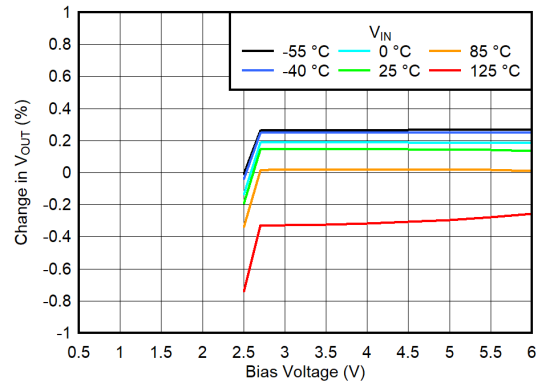

$C_{IN} = C_{OUT} = 10\ \mu\text{F}$, $C_{BIAS} = 1\ \mu\text{F}$, $C_{SS} = 0\ \text{nF}$, $V_{IN} = 0.95\text{ V}$, $V_{EN} = 1.1\text{ V}$

图 6-20. BIAS Line Regulation for $V_{OUT} = 0.65\text{ V}$, $I_{OUT} = 10\text{ mA}$

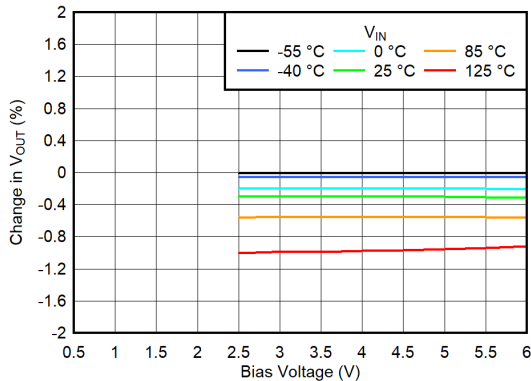

$C_{IN} = C_{OUT} = 10\ \mu\text{F}$, $C_{BIAS} = 1\ \mu\text{F}$, $C_{SS} = 0\ \text{nF}$, $V_{IN} = 0.95\text{ V}$, $V_{EN} = 1.1\text{ V}$

图 6-21. BIAS Line Regulation for $V_{OUT} = 0.65\text{ V}$, $I_{OUT} = 1.5\text{ A}$

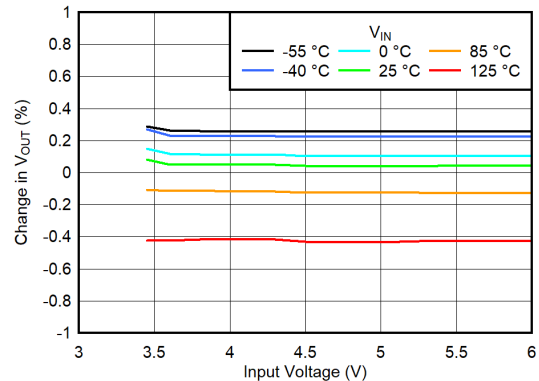

$C_{IN} = C_{OUT} = 10\ \mu\text{F}$, $C_{BIAS} = 1\ \mu\text{F}$, $C_{SS} = 0\ \text{nF}$, $V_{BIAS} = 5\text{ V}$, $V_{EN} = 1.1\text{ V}$

图 6-22. IN Line Regulation for $V_{OUT} = 3.3\text{ V}$, $I_{OUT} = 0\text{ A}$

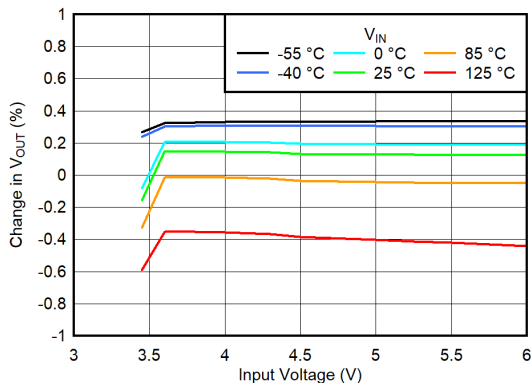

$C_{IN} = C_{OUT} = 10\ \mu\text{F}$, $C_{BIAS} = 1\ \mu\text{F}$, $C_{SS} = 0\ \text{nF}$, $V_{BIAS} = 5\text{ V}$, $V_{EN} = 1.1\text{ V}$

图 6-23. IN Line Regulation for $V_{OUT} = 3.3\text{ V}$, $I_{OUT} = 10\text{ mA}$

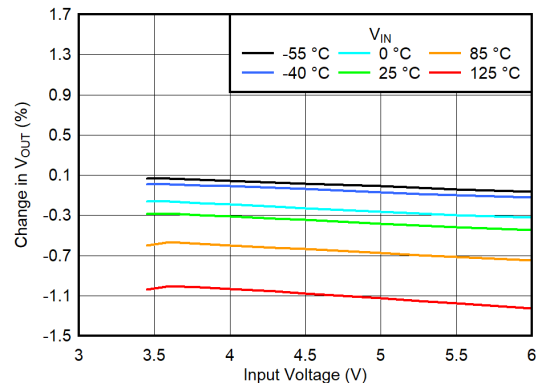

$C_{IN} = C_{OUT} = 10\ \mu\text{F}$, $C_{BIAS} = 1\ \mu\text{F}$, $C_{SS} = 0\ \text{nF}$, $V_{BIAS} = 5\text{ V}$, $V_{EN} = 1.1\text{ V}$

图 6-24. IN Line Regulation for $V_{OUT} = 3.3\text{ V}$, $I_{OUT} = 1.5\text{ A}$

6.6 Typical Characteristics (continued)

at $T_J = 25^\circ\text{C}$, $V_{IN} = V_{OUT(nom)} + 0.3\text{ V}$, $V_{BIAS} = 5\text{ V}$, $V_{EN} = V_{IN}$, $C_{IN} = 10\ \mu\text{F}$, $C_{BIAS} = 1\ \mu\text{F}$, and $C_{OUT} = 10\ \mu\text{F}$ (unless otherwise noted)

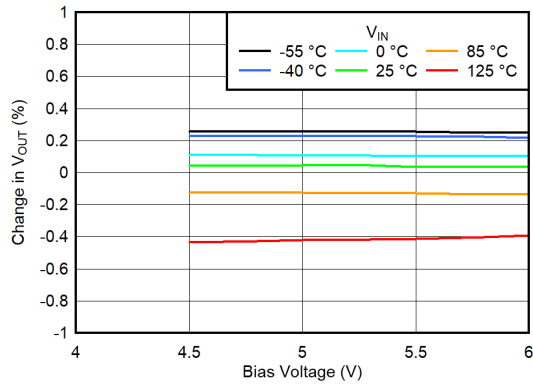

$C_{IN} = C_{OUT} = 10\ \mu\text{F}$, $C_{BIAS} = 1\ \mu\text{F}$, $C_{SS} = 0\ \text{nF}$,
 $3.6\text{ V} \leq V_{IN} \leq 6\text{ V}$, $V_{EN} = 1.1\text{ V}$

图 6-25. BIAS Line Regulation for $V_{OUT} = 3.3\text{ V}$, $I_{OUT} = 0\text{ A}$

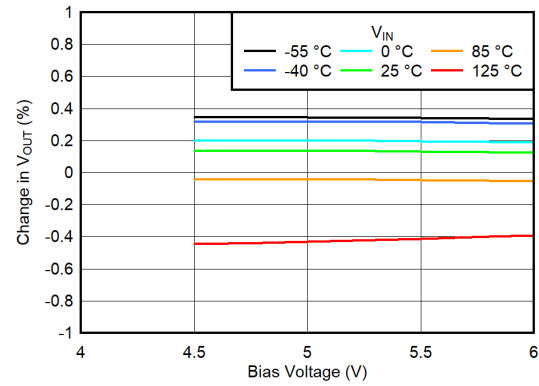

$C_{IN} = C_{OUT} = 10\ \mu\text{F}$, $C_{BIAS} = 1\ \mu\text{F}$, $C_{SS} = 0\ \text{nF}$,
 $3.6\text{ V} \leq V_{IN} \leq 6\text{ V}$, $V_{EN} = 1.1\text{ V}$

图 6-26. BIAS Line Regulation for $V_{OUT} = 3.3\text{ V}$, $I_{OUT} = 10\text{ mA}$

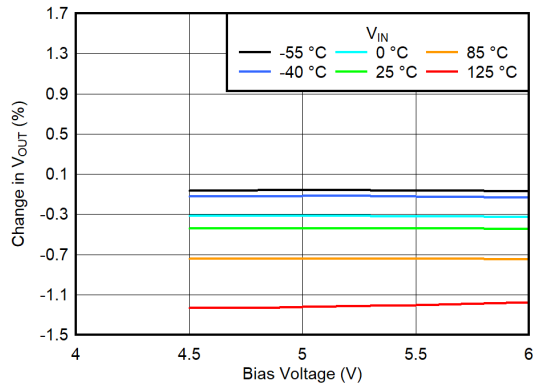

$C_{IN} = C_{OUT} = 10\ \mu\text{F}$, $C_{BIAS} = 1\ \mu\text{F}$, $C_{SS} = 0\ \text{nF}$,
 $3.6\text{ V} \leq V_{IN} \leq 6\text{ V}$, $V_{EN} = 1.1\text{ V}$

图 6-27. BIAS Line Regulation for $V_{OUT} = 3.3\text{ V}$, $I_{OUT} = 1.5\text{ A}$

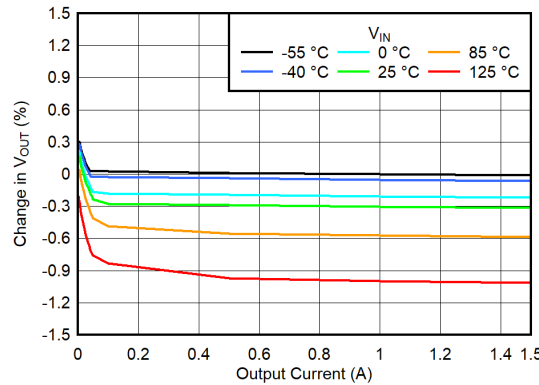

$C_{IN} = C_{OUT} = 10\ \mu\text{F}$, $C_{BIAS} = 1\ \mu\text{F}$, $C_{SS} = 0\ \text{nF}$, $V_{IN} = 0.95\text{ V}$,
 $2.3\text{ V} \leq V_{BIAS} \leq 5\text{ V}$, $V_{EN} = 1.1\text{ V}$

图 6-28. Load Regulation for $I_{OUT} = 0\text{ A}$ to Load,
 $V_{OUT} = 0.65\text{ V}$

6.6 Typical Characteristics (continued)

at $T_J = 25^\circ\text{C}$, $V_{IN} = V_{OUT(nom)} + 0.3\text{ V}$, $V_{BIAS} = 5\text{ V}$, $V_{EN} = V_{IN}$, $C_{IN} = 10\ \mu\text{F}$, $C_{BIAS} = 1\ \mu\text{F}$, and $C_{OUT} = 10\ \mu\text{F}$ (unless otherwise noted)

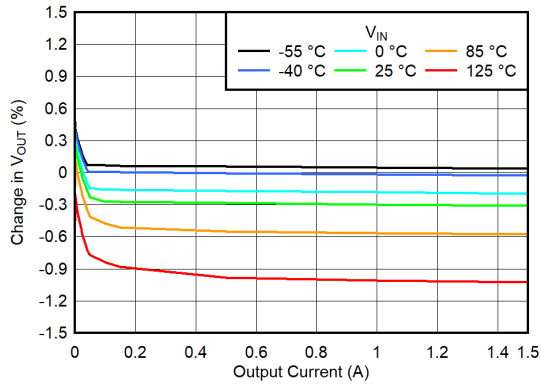

$C_{IN} = C_{OUT} = 10\ \mu\text{F}$, $C_{BIAS} = 1\ \mu\text{F}$, $C_{SS} = 0\ \text{nF}$, $V_{IN} = 0.95\text{ V}$,
 $V_{BIAS} = 5\text{ V}$, $V_{EN} = 1.1\text{ V}$

图 6-29. Load Regulation for $I_{OUT} = 0\text{ A}$ to Load, $V_{OUT} = 3.3\text{ V}$

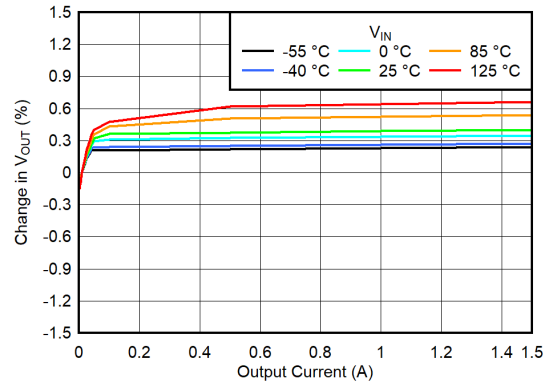

$C_{IN} = C_{OUT} = 10\ \mu\text{F}$, $C_{BIAS} = 1\ \mu\text{F}$, $C_{SS} = 0\ \text{nF}$, $V_{IN} = 0.95\text{ V}$,
 $2.3\text{ V} \leq V_{BIAS} \leq 5\text{ V}$, $V_{EN} = 1.1\text{ V}$

图 6-30. Load Regulation for $I_{OUT} = 10\text{ mA}$ to Load, $V_{OUT} = 0.65\text{ V}$

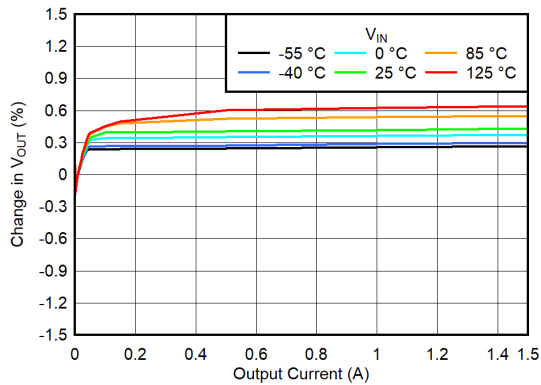

$C_{IN} = C_{OUT} = 10\ \mu\text{F}$, $C_{BIAS} = 1\ \mu\text{F}$, $C_{SS} = 0\ \text{nF}$, $V_{IN} = 0.95\text{ V}$,
 $V_{BIAS} = 5\text{ V}$, $V_{EN} = 1.1\text{ V}$

图 6-31. Load Regulation for $I_{OUT} = 10\text{ mA}$ to Load, $V_{OUT} = 3.3\text{ V}$

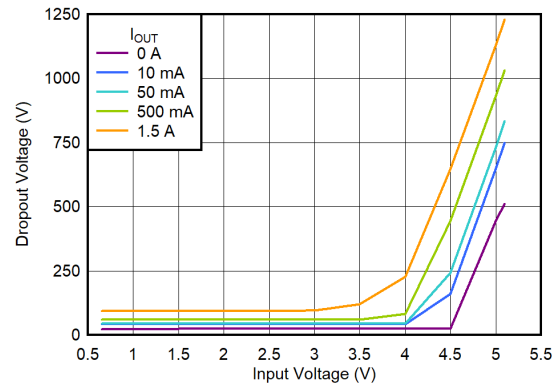

$C_{IN} = C_{OUT} = 10\ \mu\text{F}$, $C_{BIAS} = 1\ \mu\text{F}$, $C_{SS} = 0\ \text{nF}$, $V_{BIAS} = 5\text{ V}$,
 $V_{EN} = 1.1\text{ V}$

图 6-32. Dropout Voltage vs Input Voltage

6.6 Typical Characteristics (continued)

at $T_J = 25^\circ\text{C}$, $V_{IN} = V_{OUT(nom)} + 0.3\text{ V}$, $V_{BIAS} = 5\text{ V}$, $V_{EN} = V_{IN}$, $C_{IN} = 10\ \mu\text{F}$, $C_{BIAS} = 1\ \mu\text{F}$, and $C_{OUT} = 10\ \mu\text{F}$ (unless otherwise noted)

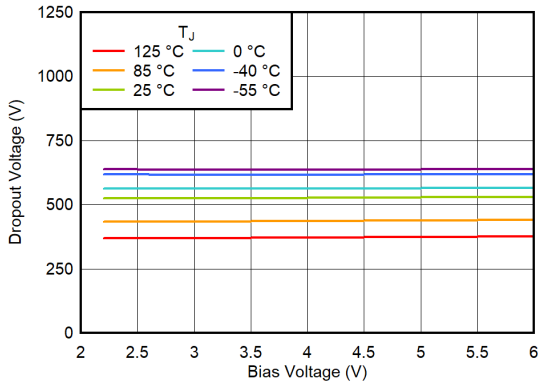

$C_{IN} = C_{OUT} = 10\ \mu\text{F}$, $C_{BIAS} = 1\ \mu\text{F}$, $C_{SS} = 0\ \text{nF}$, $V_{BIAS} = V_{IN}$,
 $V_{EN} = 1.1\text{ V}$

图 6-33. Dropout Voltage vs Bias Voltage for $I_{OUT} = 0\text{ A}$

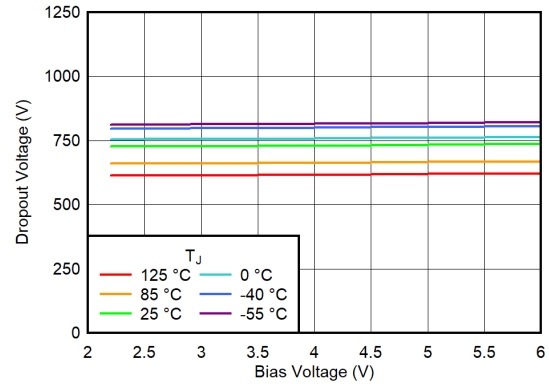

$C_{IN} = C_{OUT} = 10\ \mu\text{F}$, $C_{BIAS} = 1\ \mu\text{F}$, $C_{SS} = 0\ \text{nF}$, $V_{BIAS} = V_{IN}$,
 $V_{EN} = 1.1\text{ V}$

图 6-34. Dropout Voltage vs Bias Voltage for $I_{OUT} = 50\text{ mA}$

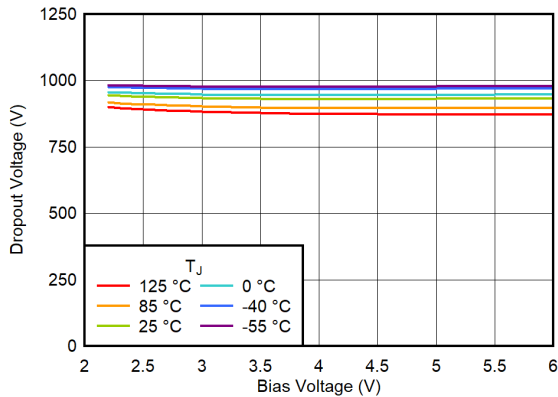

$C_{IN} = C_{OUT} = 10\ \mu\text{F}$, $C_{BIAS} = 1\ \mu\text{F}$, $C_{SS} = 0\ \text{nF}$, $V_{BIAS} = V_{IN}$,
 $V_{EN} = 1.1\text{ V}$

图 6-35. Dropout Voltage vs Bias Voltage for $I_{OUT} = 500\text{ mA}$

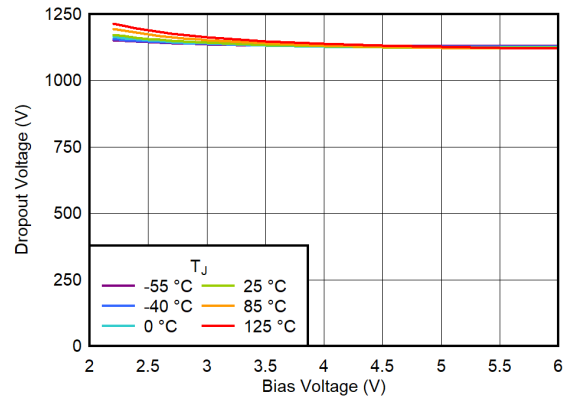

$C_{IN} = C_{OUT} = 10\ \mu\text{F}$, $C_{BIAS} = 1\ \mu\text{F}$, $C_{SS} = 0\ \text{nF}$, $V_{BIAS} = V_{IN}$,
 $V_{EN} = 1.1\text{ V}$

图 6-36. Dropout Voltage vs Bias Voltage for $I_{OUT} = 1.5\text{ A}$

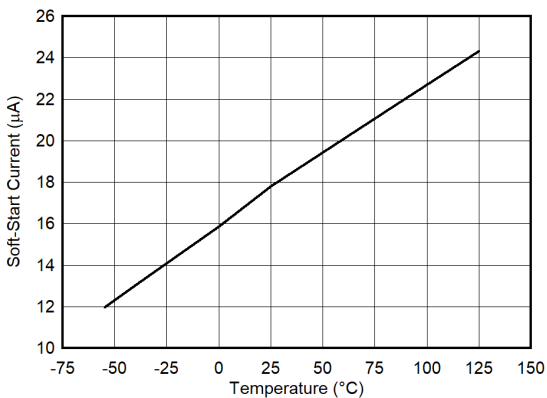

$C_{IN} = C_{OUT} = 10\ \mu\text{F}$, $C_{BIAS} = 1\ \mu\text{F}$, $C_{SS} = 0\ \text{nF}$, $V_{BIAS} = V_{IN} = 6\text{ V}$, $V_{OUT} = 0.65\text{ V}$, $V_{EN} = 1.5\text{ V}$, $I_{OUT} = 0\text{ A}$

图 6-37. Soft-Start Current vs Temperature

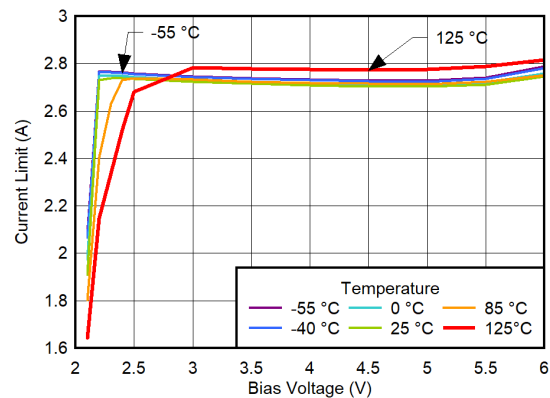

$C_{IN} = C_{OUT} = 10\ \mu\text{F}$, $C_{BIAS} = 1\ \mu\text{F}$, $C_{SS} = 0\ \text{nF}$, $V_{IN} = 0.95\text{ V}$,
 $V_{EN} = 1.1\text{ V}$

图 6-38. Current Limit vs Bias Voltage for $V_{OUT} = 0.65\text{ V}$

6.6 Typical Characteristics (continued)

at $T_J = 25^\circ\text{C}$, $V_{IN} = V_{OUT(nom)} + 0.3\text{ V}$, $V_{BIAS} = 5\text{ V}$, $V_{EN} = V_{IN}$, $C_{IN} = 10\ \mu\text{F}$, $C_{BIAS} = 1\ \mu\text{F}$, and $C_{OUT} = 10\ \mu\text{F}$ (unless otherwise noted)

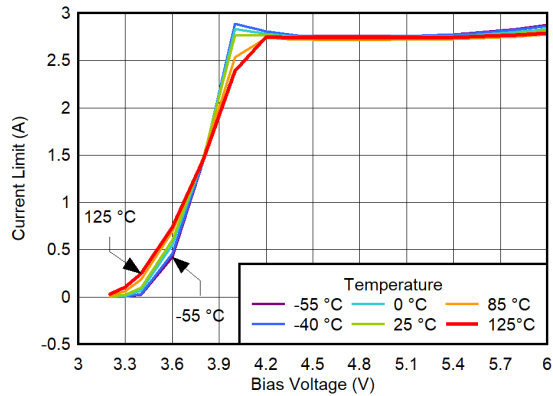

$C_{IN} = C_{OUT} = 10\ \mu\text{F}$, $C_{BIAS} = 1\ \mu\text{F}$, $C_{SS} = 0\ \text{nF}$, $V_{IN} = 3.6\text{ V}$, $V_{EN} = 1.1\text{ V}$

图 6-39. Current Limit vs Bias Voltage for $V_{OUT} = 3.3\text{ V}$

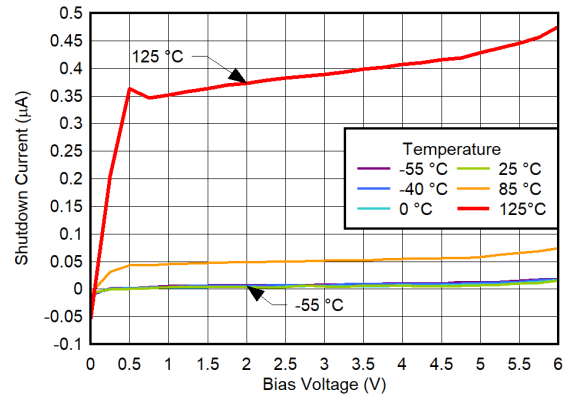

$C_{IN} = C_{OUT} = 10\ \mu\text{F}$, $C_{BIAS} = 1\ \mu\text{F}$, $C_{SS} = 0\ \text{nF}$, $V_{EN} = 0.4\text{ V}$

图 6-40. Shutdown Current vs Bias Voltage for $V_{IN} = 0.95\text{ V}$

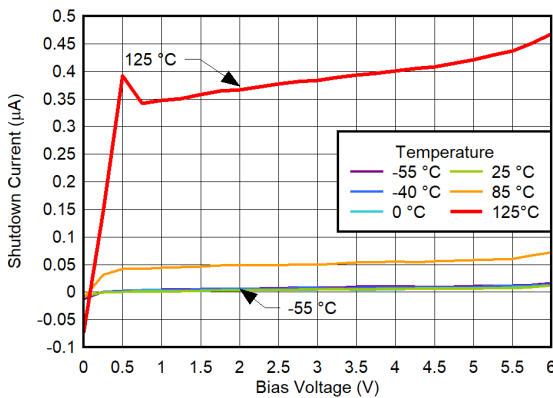

$C_{IN} = C_{OUT} = 10\ \mu\text{F}$, $C_{BIAS} = 1\ \mu\text{F}$, $C_{SS} = 0\ \text{nF}$, $V_{EN} = 0.4\text{ V}$

图 6-41. Shutdown Current vs Bias Voltage for $V_{IN} = 6\text{ V}$

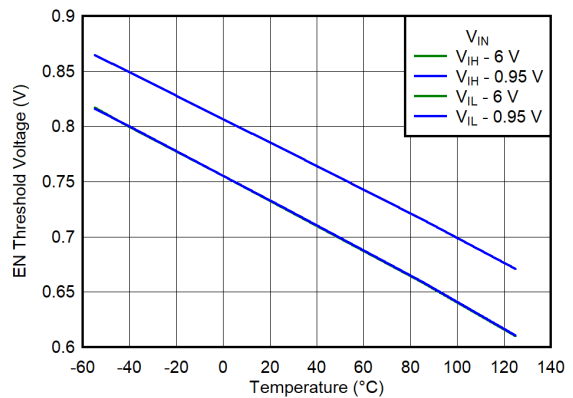

$C_{IN} = C_{OUT} = 10\ \mu\text{F}$, $C_{BIAS} = 1\ \mu\text{F}$, $C_{SS} = 0\ \text{nF}$, $V_{BIAS} = 6\text{ V}$

图 6-42. Enable Voltage Threshold vs Temperature

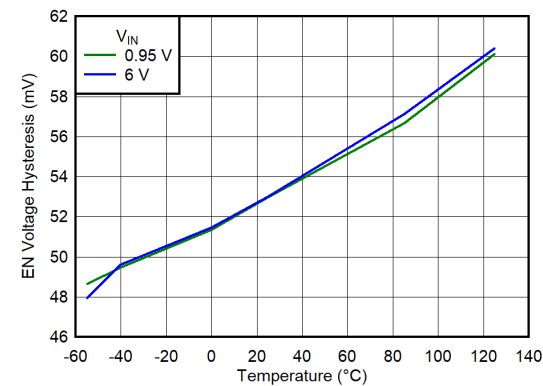

$C_{IN} = C_{OUT} = 10\ \mu\text{F}$, $C_{BIAS} = 1\ \mu\text{F}$, $C_{SS} = 0\ \text{nF}$, $V_{BIAS} = 6\text{ V}$

图 6-43. Enable Voltage Hysteresis vs Temperature

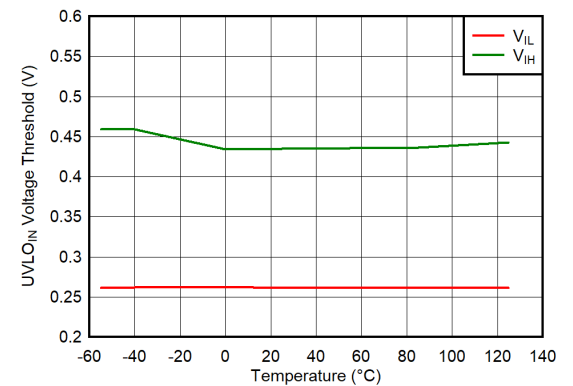

$C_{IN} = C_{OUT} = 10\ \mu\text{F}$, $C_{BIAS} = 1\ \mu\text{F}$, $C_{SS} = 0\ \text{nF}$, $V_{BIAS} = 5\text{ V}$, $1.1\text{ V} \leq V_{EN} \leq 6\text{ V}$

图 6-44. $UVLO_{IN}$ Voltage Threshold vs Temperature

6.6 Typical Characteristics (continued)

at $T_J = 25^\circ\text{C}$, $V_{IN} = V_{OUT(nom)} + 0.3\text{ V}$, $V_{BIAS} = 5\text{ V}$, $V_{EN} = V_{IN}$, $C_{IN} = 10\ \mu\text{F}$, $C_{BIAS} = 1\ \mu\text{F}$, and $C_{OUT} = 10\ \mu\text{F}$ (unless otherwise noted)

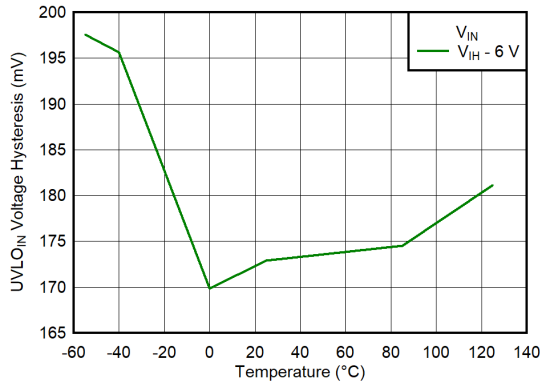

$C_{IN} = C_{OUT} = 10\ \mu\text{F}$, $C_{BIAS} = 1\ \mu\text{F}$, $C_{SS} = 0\text{ nF}$, $V_{BIAS} = 5\text{ V}$,
 $1.1\text{ V} \leq V_{EN} \leq 6\text{ V}$

图 6-45. UVLO_{IN} Voltage Hysteresis vs Temperature

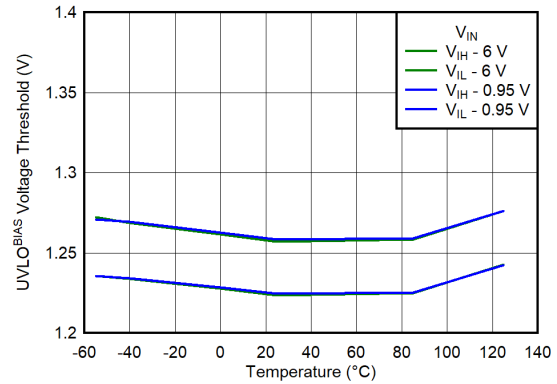

$C_{IN} = C_{OUT} = 10\ \mu\text{F}$, $C_{BIAS} = 1\ \mu\text{F}$, $C_{SS} = 0\text{ nF}$, $V_{BIAS} = 5\text{ V}$,
 $1.1\text{ V} \leq V_{EN} \leq 6\text{ V}$

图 6-46. UVLO_{BIAS} Voltage Threshold vs Temperature

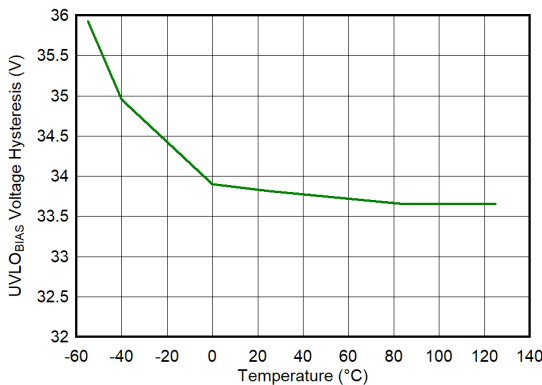

$C_{IN} = C_{OUT} = 10\ \mu\text{F}$, $C_{BIAS} = 1\ \mu\text{F}$, $C_{SS} = 0\text{ nF}$, $V_{BIAS} = 5\text{ V}$,
 $1.1\text{ V} \leq V_{EN} \leq 6\text{ V}$

图 6-47. UVLO_{BIAS} Voltage Hysteresis vs Temperature

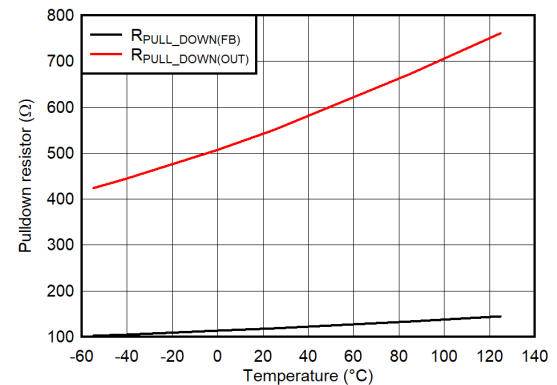

$C_{IN} = C_{OUT} = 10\ \mu\text{F}$, $C_{BIAS} = 1\ \mu\text{F}$, $C_{SS} = 0\text{ nF}$, $V_{BIAS} = 6\text{ V}$,
 $V_{EN} \leq 0.4\text{ V}$

图 6-48. Pulldown Resistors vs Temperature

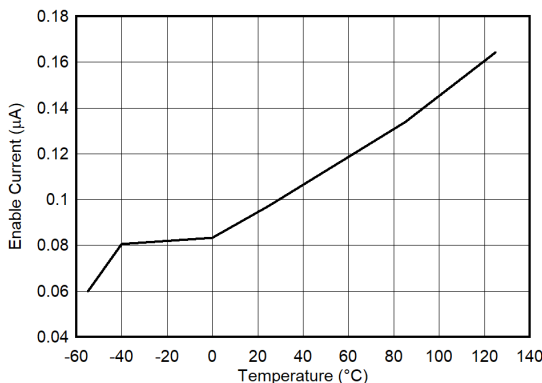

$C_{IN} = C_{OUT} = 10\ \mu\text{F}$, $C_{BIAS} = 1\ \mu\text{F}$, $C_{SS} = 0\text{ nF}$, $V_{IN} = 6\text{ V}$,
 $V_{OUT(NOM)} = 0.65\text{ V}$, $V_{BIAS} = 6\text{ V}$, $I_{OUT} = 2\text{ mA}$, $V_{EN} = 6\text{ V}$

图 6-49. EN Pin Current vs Temperature

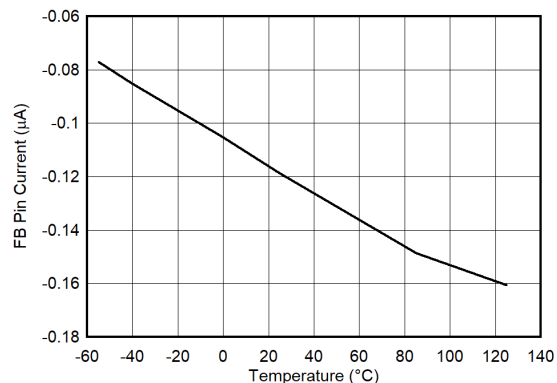

$C_{IN} = C_{OUT} = 10\ \mu\text{F}$, $C_{BIAS} = 1\ \mu\text{F}$, $C_{SS} = 0\text{ nF}$, $0.95\text{ V} \leq V_{IN} \leq 6\text{ V}$, $V_{OUT(NOM)} = 0.65\text{ V}$, $V_{BIAS} = 6\text{ V}$, $I_{OUT} = 2\text{ mA}$, $V_{EN} = 6\text{ V}$

图 6-50. FB Pin Current vs Temperature

6.6 Typical Characteristics (continued)

at $T_J = 25^\circ\text{C}$, $V_{IN} = V_{OUT(nom)} + 0.3\text{ V}$, $V_{BIAS} = 5\text{ V}$, $V_{EN} = V_{IN}$, $C_{IN} = 10\ \mu\text{F}$, $C_{BIAS} = 1\ \mu\text{F}$, and $C_{OUT} = 10\ \mu\text{F}$ (unless otherwise noted)

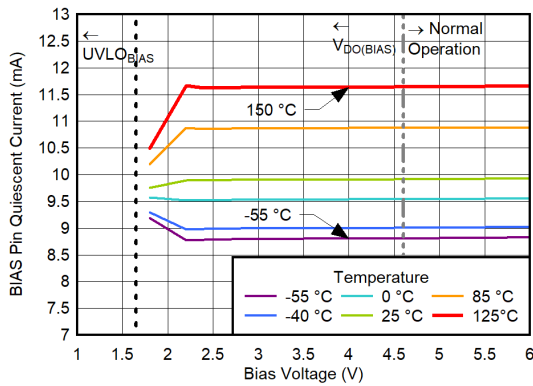

$C_{IN} = C_{OUT} = 10\ \mu\text{F}$, $C_{BIAS} = 1\ \mu\text{F}$, $C_{SS} = 0\ \text{nF}$, $V_{IN} = 3.6\text{ V}$,
 $V_{OUT} = 3.3\text{ V}$, $V_{EN} = 1.1\text{ V}$

图 6-51. BIAS Pin Quiescent Current vs Bias Voltage for $I_{OUT} = 1.5\text{ A}$

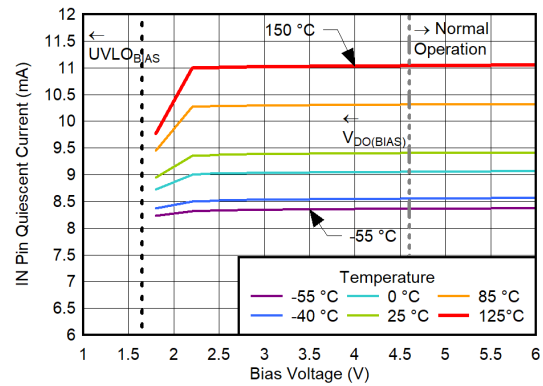

$C_{IN} = C_{OUT} = 10\ \mu\text{F}$, $C_{BIAS} = 1\ \mu\text{F}$, $C_{SS} = 0\ \text{nF}$, $V_{IN} = 3.6\text{ V}$,
 $V_{OUT} = 3.3\text{ V}$, $V_{EN} = 1.1\text{ V}$

图 6-52. IN Pin Quiescent Current vs Bias Voltage for $I_{OUT} = 1.5\text{ A}$

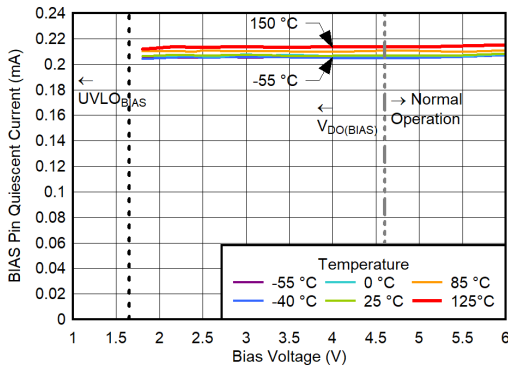

$C_{IN} = C_{OUT} = 10\ \mu\text{F}$, $C_{BIAS} = 1\ \mu\text{F}$, $C_{SS} = 0\ \text{nF}$, $V_{IN} = 3.6\text{ V}$,
 $V_{OUT} = 3.3\text{ V}$, $V_{EN} = 1.1\text{ V}$

图 6-53. BIAS Pin Quiescent Current vs Bias Voltage for $I_{OUT} = 10\text{ mA}$

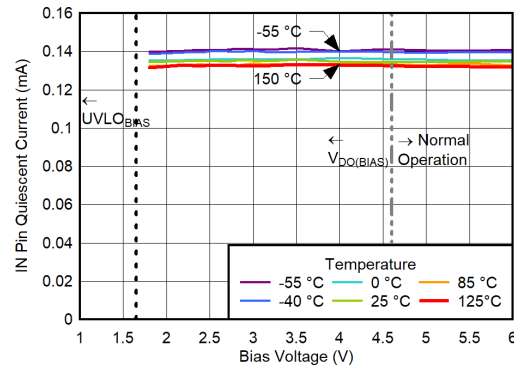

$C_{IN} = C_{OUT} = 10\ \mu\text{F}$, $C_{BIAS} = 1\ \mu\text{F}$, $C_{SS} = 0\ \text{nF}$, $V_{IN} = 3.6\text{ V}$,
 $V_{OUT} = 3.3\text{ V}$, $V_{EN} = 1.1\text{ V}$

图 6-54. IN Pin Quiescent Current vs Bias Voltage for $I_{OUT} = 10\text{ mA}$

6.6 Typical Characteristics (continued)

at $T_J = 25^\circ\text{C}$, $V_{IN} = V_{OUT(nom)} + 0.3\text{ V}$, $V_{BIAS} = 5\text{ V}$, $V_{EN} = V_{IN}$, $C_{IN} = 10\ \mu\text{F}$, $C_{BIAS} = 1\ \mu\text{F}$, and $C_{OUT} = 10\ \mu\text{F}$ (unless otherwise noted)

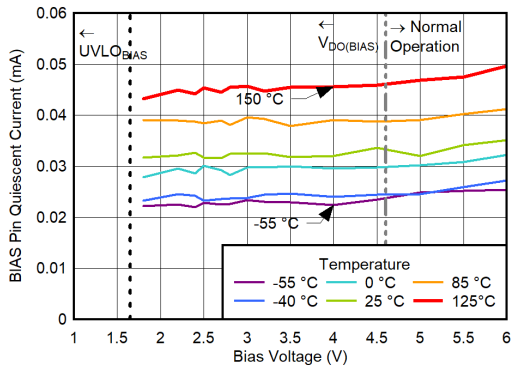

$C_{IN} = C_{OUT} = 10\ \mu\text{F}$, $C_{BIAS} = 1\ \mu\text{F}$, $C_{SS} = 0\ \text{nF}$, $V_{IN} = 3.6\text{ V}$,
 $V_{OUT} = 3.3\text{ V}$, $V_{EN} = 1.1\text{ V}$

图 6-55. BIAS Pin Quiescent Current vs Bias Voltage for $I_{OUT} = 0\text{ A}$
A

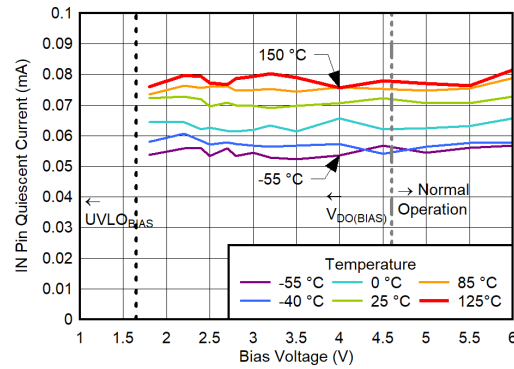

$C_{IN} = C_{OUT} = 10\ \mu\text{F}$, $C_{BIAS} = 1\ \mu\text{F}$, $C_{SS} = 0\ \text{nF}$, $V_{IN} = 3.6\text{ V}$,
 $V_{OUT} = 3.3\text{ V}$, $V_{EN} = 1.1\text{ V}$

图 6-56. IN Pin Quiescent Current vs Bias Voltage for $I_{OUT} = 0\text{ A}$

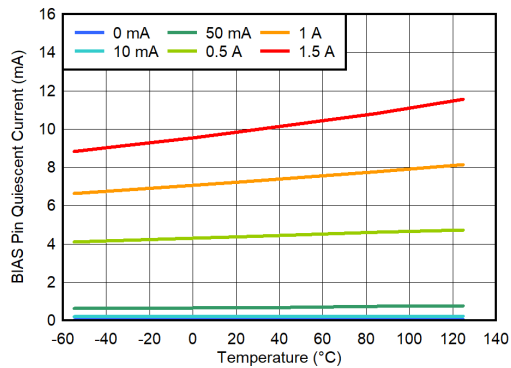

$C_{IN} = C_{OUT} = 10\ \mu\text{F}$, $C_{BIAS} = 1\ \mu\text{F}$, $C_{SS} = 0\ \text{nF}$, $V_{IN} = 3.6\text{ V}$,
 $V_{OUT} = 3.3\text{ V}$, $V_{BIAS} = 5\text{ V}$, $V_{EN} = 1.1\text{ V}$

图 6-57. BIAS Pin Quiescent Current vs Temperature

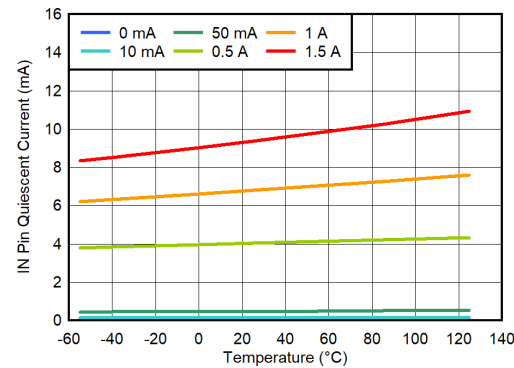

$C_{IN} = C_{OUT} = 10\ \mu\text{F}$, $C_{BIAS} = 1\ \mu\text{F}$, $C_{SS} = 0\ \text{nF}$, $V_{IN} = 3.6\text{ V}$,
 $V_{OUT} = 3.3\text{ V}$, $V_{BIAS} = 5\text{ V}$, $V_{EN} = 1.1\text{ V}$

图 6-58. IN Pin Quiescent Current vs Temperature

7 Detailed Description

7.1 Overview

The TPS7A74 is a low-input, low-output, low-quiescent-current linear regulator optimized to support excellent transient performance. This regulator uses a low-current bias rail to power all internal control circuitry, allowing the n-type field effect transistor (NMOS) pass transistor to regulate very-low input and output voltages.

Using an NMOS-pass transistor offers several critical advantages for many applications. Unlike a p-channel metal-oxide-semiconductor field effect transistor (PMOS) topology device, the output capacitor has little effect on loop stability. This architecture allows the TPS7A74 to be stable with any ceramic capacitor 10 μ F or greater. Transient response is also superior to PMOS topologies, particularly for low V_{IN} applications.

The TPS7A74 features a programmable voltage-controlled, soft-start circuit that provides a smooth, monotonic start-up and limits start-up inrush currents that can be caused by large capacitive loads. An enable (EN) pin with hysteresis and deglitch allows slow-ramping signals to be used for sequencing the device. The low V_{IN} and V_{OUT} capability allows for inexpensive, easy-to-design, and efficient linear regulation between the multiple supply voltages often required by processor-intensive systems.

7.2 Functional Block Diagram

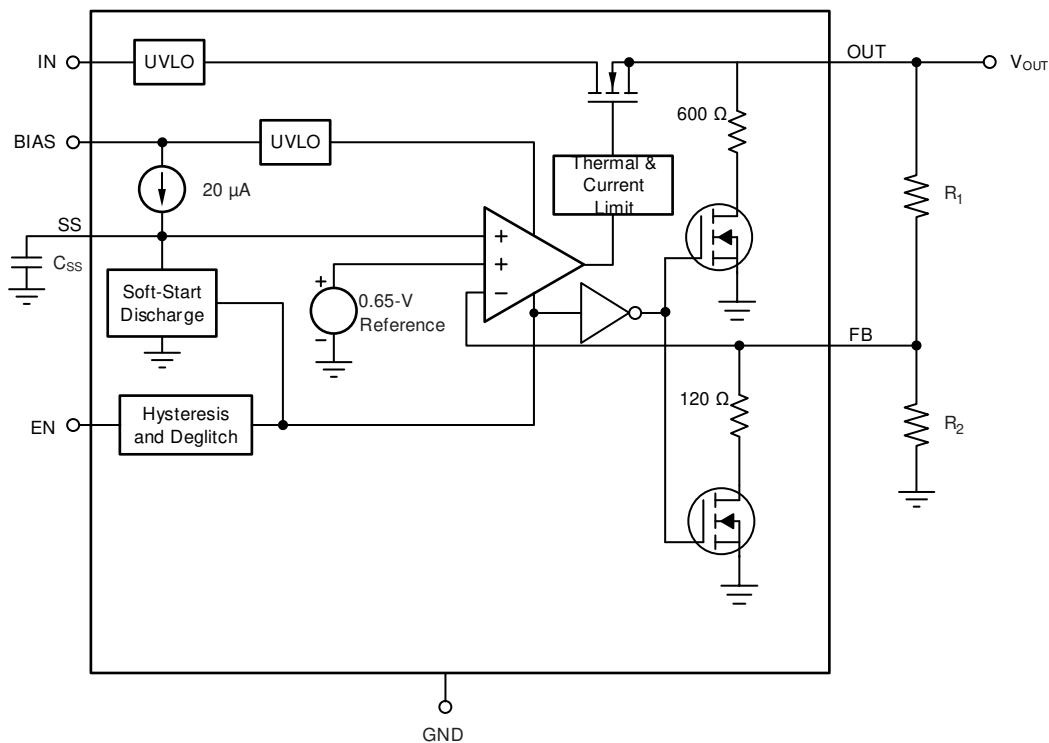

7.3 Feature Description

7.3.1 Enable and Shutdown

The enable (EN) pin is active high and compatible with standard digital-signaling levels. Setting V_{EN} below 0.4 V turns the regulator off, and setting V_{EN} above 1.1 V turns the regulator on. Unlike many regulators, the enable circuitry has hysteresis and deglitching for use with relatively slowly ramping analog signals. This configuration allows the device to be enabled by connecting the output of another supply to the EN pin. The enable circuitry typically has 50 mV of hysteresis and a deglitch circuit to help avoid on-off cycling as a result of small glitches in the V_{EN} signal.

The enable threshold is typically 0.75 V and varies with temperature and process variations, see [Figure 6-42](#). Temperature variation is approximately $-1.2 \text{ mV}/^\circ\text{C}$; process variation accounts for most of the rest of the variation to the 0.4-V and 1.1-V limits. If precise turn-on timing is required, a fast rise-time signal must be used.

If not used, EN can be connected to BIAS. Place the connection as close as possible to the bias capacitor.

7.3.2 Active Discharge

The TPS7A74 has two internal active pulldown circuits: one on the FB pin and one on the OUT pin.

Each active discharge function uses an internal metal-oxide-semiconductor field-effect transistor (MOSFET) that connects a resistor ($R_{PULLDOWN}$) to ground when the low-dropout resistor (LDO) is disabled in order to actively discharge the output voltage. The active discharge circuit is activated when the device is disabled by driving EN to logic low, when the voltage at IN or BIAS is below the UVLO threshold, or when the regulator is in thermal shutdown.

The discharge time after disabling the device depends on the output capacitance (C_{OUT}) and the load resistance (R_L) in parallel with the pulldown resistor.

The first active pulldown circuit connects the output to GND through a 600- Ω resistor when the device is disabled.

The second circuit connects FB to GND through a 120- Ω resistor when the device is disabled. This resistor discharges the FB pin. [Equation 1](#) calculates the output capacitor discharge time constant when OUT is shorted to FB, or when the output voltage is set to 0.65 V.

$$\tau_{OUT} = (600 \parallel 120 \times R_L / (600 \parallel 120 + R_L)) \times C_{OUT} \quad (1)$$

If the LDO is set to an output voltage greater than 0.65 V, a resistor divider network is in place and minimizes the FB pin pulldown. [Equation 2](#) and [Equation 3](#) calculate the time constants set by these discharge resistors.

$$R_{DISCHARGE} = (120 \parallel R_2) + R_1 \quad (2)$$

$$\tau_{OUT} = R_{DISCHARGE} \times R_L / (R_{DISCHARGE} + R_L) \times C_{OUT} \quad (3)$$

Do not rely on the active discharge circuit for discharging a large amount of output capacitance after the input supply has collapsed because reverse current can flow from the output to the input and can cause damage to the device. Limit reverse current to no more than 5% of the device-rated current.

See [Figure 6-48](#) for additional information.

7.3.3 Global Undervoltage Lockout (UVLO) Circuit

Two undervoltage lockout (UVLO) circuits are present to prevent the TPS7A74 from turning on with an insufficient rail. One circuit is present on the BIAS pin and the other circuit is on the IN pin. The two UVLO signals are connected internally through an AND gate, as shown in 图 7-1, that turns off the device when the voltage on either input is below their respective UVLO thresholds.

In other words, the output is disabled until the IN pin voltage reaches a value greater than $UVLO_{IN}$ and the BIAS pin voltage reaches a voltage greater than $UVLO_{BIAS}$.



图 7-1. Global UVLO Circuit

7.3.4 Internal Current Limit

The device has an internal current-limit circuit that protects the regulator during transient high-load current faults or shorting events. The current limit is a hybrid brick-wall foldback scheme. The current limit transitions from a brick-wall scheme to a foldback scheme at the foldback voltage ($V_{FOLDBACK}$). In a high-load current fault with the output voltage above $V_{FOLDBACK}$, the brick-wall scheme limits the output current to the current limit (I_{CL}). When the voltage drops below $V_{FOLDBACK}$, a foldback current limit activates that scales back the current when the output voltage approaches GND. When the output is shorted, the device supplies a typical current called the *short-circuit current limit* (I_{SC}). I_{CL} and I_{SC} are listed in the [Electrical Characteristics](#) table.

For this device, $V_{FOLDBACK}$ is approximately $60\% \times V_{OUT(nom)}$.

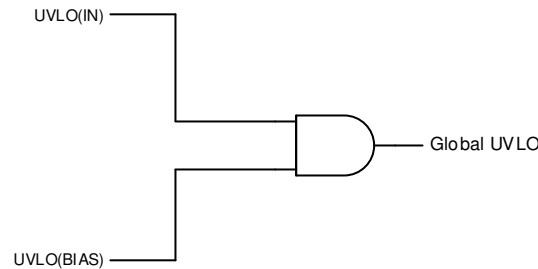
The output voltage is not regulated when the device is in current limit. When a current-limit event occurs, the device begins to heat up because of the increase in power dissipation. When the device is in a brick-wall current limit, the pass transistor dissipates power $[(V_{IN} - V_{OUT}) \times I_{CL}]$. When the device output is shorted and the output is below $V_{FOLDBACK}$, the pass transistor dissipates power $[(V_{IN} - V_{OUT}) \times I_{SC}]$. If thermal shutdown is triggered, the device turns off. When the device sufficiently cools down, the internal thermal shutdown circuit turns the device back on. If the output current fault condition continues, the device cycles between current limit and thermal shutdown. For more information on current limits, see the [Know Your Limits application note](#). 图 7-2 illustrates a diagram of the foldback current limit.



图 7-2. Foldback Current Limit

7.3.5 Thermal Shutdown Protection (T_{SD})

The internal thermal shutdown protection circuit disables the output when the thermal junction temperature (T_J) of the pass transistor rises to the thermal shutdown temperature threshold, $T_{SD(\text{shutdown})}$ (typical). The thermal shutdown circuit hysteresis ensures that the LDO resets (turns on) when the temperature falls to $T_{SD(\text{reset})}$ (typical).

The thermal time constant of the semiconductor die is fairly short; thus, the device may cycle on and off when thermal shutdown is reached until the power dissipation is reduced. Power dissipation during start up can be high from large $V_{IN} - V_{OUT}$ voltage drops across the device or from high inrush currents charging large output capacitors. Under some conditions, the thermal shutdown protection disables the device before start up completes.

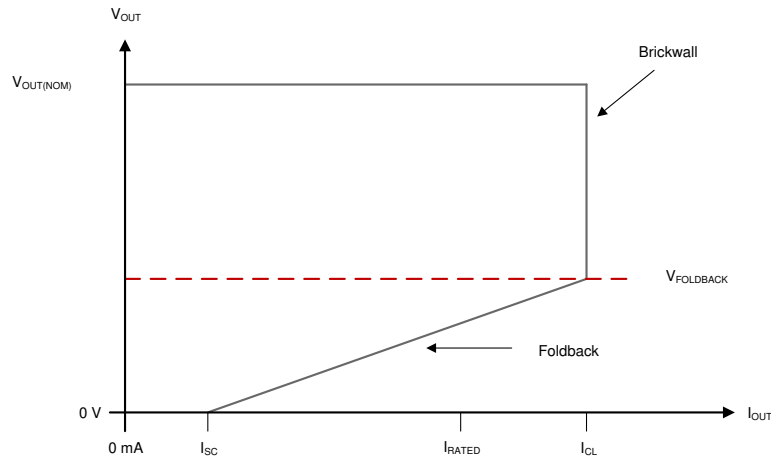
For reliable operation, limit the junction temperature to the maximum listed in the [Recommended Operating Conditions](#) table. Operation above this maximum temperature causes the device to exceed operational specifications. Although the internal protection circuitry is designed to protect against thermal overload conditions, this circuitry is not intended to replace proper heat sinking. Continuously running the regulator into thermal shutdown, or above the maximum recommended junction temperature, reduces long-term reliability.

7.4 Device Functional Modes

表 7-1 shows the conditions that lead to the different modes of operation. See the [Electrical Characteristics](#) table for parameter values.

表 7-1. Device Functional Mode Comparison

OPERATING MODE	PARAMETER				
	V_{IN}	V_{BIAS}	V_{EN}	I_{OUT}	T_J
Normal mode	$V_{IN} \geq V_{OUT(nom)} + V_{DO}$ and $V_{IN} \geq V_{IN(min)}$	$V_{BIAS} \geq V_{OUT} + V_{DO(BIAS)}$	$V_{EN} \geq V_{HI(EN)}$	$I_{OUT} < I_{CL}$	$T_J < T_{SD}$ for shutdown
Dropout mode	$V_{IN(min)} < V_{IN} < V_{OUT(nom)} + V_{DO(IN)}$	$V_{BIAS} < V_{OUT} + V_{DO(BIAS)}$	$V_{EN} > V_{HI(EN)}$	$I_{OUT} < I_{CL}$	$T_J < T_{SD}$ for shutdown
Disabled mode (any true condition disables the device)	$V_{IN} < V_{UVLO(IN)}$	$V_{BIAS} < V_{BIAS(UVLO)}$	$V_{EN} < V_{LO(EN)}$	—	$T_J \geq T_{SD}$ for shutdown

7.4.1 Normal Operation

The device regulates to the nominal output voltage when the following conditions are met:

- The input voltage is greater than the nominal output voltage plus the dropout voltage ($V_{OUT(nom)} + V_{DO}$)
- The bias voltage is greater than the nominal output voltage plus the dropout voltage ($V_{OUT(nom)} + V_{DO}$)
- The output current is less than the current limit ($I_{OUT} < I_{CL}$)
- The device junction temperature is less than the thermal shutdown temperature ($T_J < T_{SD(shutdown)}$)
- The enable voltage has previously exceeded the enable rising threshold voltage and has not yet decreased to less than the enable falling threshold

7.4.2 Dropout Operation

If the input voltage is lower than the nominal output voltage plus the specified dropout voltage, but all other conditions are met for normal operation, the device operates in dropout mode. Similarly, if the bias voltage is lower than the nominal output voltage plus the specified dropout voltage, but all other conditions are met for normal operation, the device operates in dropout mode as well. In this mode, the output voltage tracks the input voltage. During this mode, the transient performance of the device becomes significantly degraded because the pass transistor is in the ohmic or triode region, and functions as a switch. Line or load transients in dropout can result in large output voltage deviations.

When operating in dropout, the ground current may increase. For dropout operation and the effect on the IN and BIAS current, see [图 6-51](#) to [图 6-56](#).

When the device is in a steady dropout state, defined as when the device is in dropout, ($V_{IN} < V_{OUT} + V_{DO}$ or $V_{BIAS} < V_{OUT} + V_{DO}$ directly after being in normal regulation state, but not during start up), the pass transistor is driven into the ohmic or triode region. When the input voltage returns to a value greater than or equal to the nominal output voltage plus the dropout voltage ($V_{OUT(NOM)} + V_{DO}$), the output voltage can overshoot for a short time when the device pulls the pass transistor back into the linear region.

7.4.3 Disabled

The output of the device can be shutdown by forcing the voltage of the enable pin to less than $V_{IL(EN)}$ (see the [Electrical Characteristics](#) table). When disabled, the pass transistor is turned off, internal circuits are shutdown, and the output voltage is actively discharged to ground by an internal discharge circuit from the output to ground.

The device is disabled under the following conditions:

- The input or bias voltages are below the respective minimum specifications
- The enable voltage is less than the enable falling threshold voltage or has not yet exceeded the enable rising threshold
- The device junction temperature is greater than the thermal shutdown temperature

7.5 Programming

7.5.1 Programmable Soft-Start

The TPS7A74 features a programmable, monotonic, voltage-controlled soft-start that is set with an external capacitor (C_{SS}). This feature is important for many applications because the soft-start eliminates power-up initialization problems when powering FPGAs, DSPs, or other processors. The controlled voltage ramp of the output also reduces peak inrush current during start-up, minimizing start-up transient events to the input power bus.

To achieve a linear and monotonic soft-start, the error amplifier tracks the voltage ramp of the external soft-start capacitor until the voltage exceeds the internal reference. The soft-start ramp time depends on the soft-start charging current (I_{SS}), soft-start capacitance (C_{SS}), and the internal reference voltage (V_{REF}). 方程式 4 calculates the soft-start ramp time.

$$t_{SS} = \frac{V_{REF} \times C_{SS}}{I_{SS}} \quad (4)$$

If large output capacitors are used, the device current limit (I_{CL}) and the output capacitor may set the start-up time. The start-up time is given by 方程式 5 in this case.

$$t_{SSCL} = \frac{V_{OUT(NOM)} \times C_{OUT}}{I_{CL(MIN)}} \quad (5)$$

where:

- $V_{OUT(nom)}$ is the nominal output voltage
- C_{OUT} is the output capacitance
- $I_{CL(min)}$ is the minimum current limit for the device

In applications where monotonic start up is required, the soft-start time given by 方程式 4 must be set greater than 方程式 5.

The maximum recommended soft-start capacitor is 15 nF. Larger soft-start capacitors can be used and do not damage the device; however, the soft-start capacitor discharge circuit may not be able to fully discharge the soft-start capacitor when enabled. Soft-start capacitors larger than 15 nF can be a problem in applications where the enable pin must be rapidly pulsed and the device must soft-start from ground. C_{SS} must be low-leakage; X7R, X5R, or C0G dielectric materials are preferred. 表 7-2 lists suggested soft-start capacitor values.

表 7-2. Standard Capacitor Values for Programming the Soft-Start Time⁽¹⁾

C_{SS}	SOFT-START TIME
Open	0.1 ms
1 nF	0.032 ms
5.6 nF	0.182 ms
10 nF	0.325 ms

$$(1) \quad t_{SS}(s) = \frac{V_{REF} \cdot C_{SS}}{I_{SS}} = \frac{0.65V \cdot C_{SS}(F)}{20\mu A}, \text{ where } t_{SS}(s) = \text{soft-start time in seconds.}$$

Another option to set the start-up rate is to use a feedforward capacitor; see the [Pros and Cons of Using a Feedforward Capacitor with a Low-Dropout Regulator application note](#) for more information.

7.5.2 Sequencing Requirements

V_{IN} , V_{BIAS} , and V_{EN} can be sequenced in any order without causing damage to the device. However, for the soft-start function to work as intended, certain sequencing rules must be applied. Connecting EN to IN is acceptable for most applications, as long as V_{IN} is greater than 1.1 V and the ramp rate of V_{IN} and V_{BIAS} is faster than the set soft-start ramp rate.

There are several different start-up responses that are possible, but not typical:

- If the ramp rate of the input sources is slower than the set soft-start time, the output tracks the slower supply minus the dropout voltage until reaching the set output voltage
- If EN is connected to BIAS, the device soft-starts as programmed, provided that V_{IN} is present before V_{BIAS}
- If V_{BIAS} and V_{EN} are present before V_{IN} is applied and the set soft-start time has expired, then V_{OUT} tracks V_{IN}
- If the soft-start time has not expired, the output tracks V_{IN} until V_{OUT} reaches the value set by the charging soft-start capacitor

Figure 7-3 shows the use of an RC-delay circuit to hold off V_{EN} until V_{BIAS} has ramped. This technique can also be used to drive EN from V_{IN} . An external control signal can also be used to enable the device after V_{IN} and V_{BIAS} are present.



图 7-3. Soft-Start Delay Using an RC Circuit to Enable the Device

8 Application and Implementation

备注

Information in the following applications sections is not part of the TI component specification, and TI does not warrant its accuracy or completeness. TI's customers are responsible for determining suitability of components for their purposes, as well as validating and testing their design implementation to confirm system functionality.

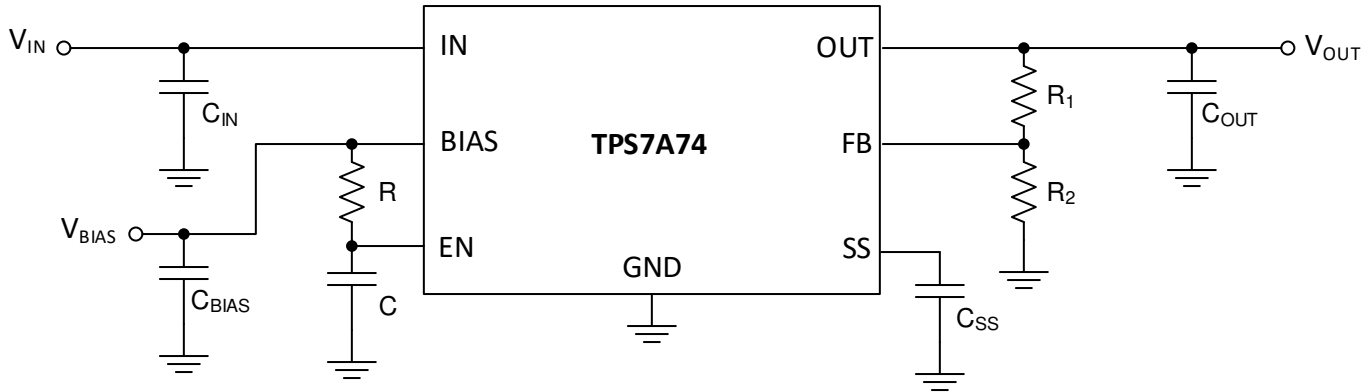
8.1 Application Information

The TPS7A74 is a low-input, low-output (LILO) low-dropout regulator (LDO) that feature soft-start capability. This regulator uses a low-current bias input to power all internal control circuitry, allowing the NMOS pass transistor to regulate very low input and output voltages.

The use of an NMOS pass transistor offers several critical advantages for many applications. Unlike a PMOS topology device, the output capacitor has little effect on loop stability. This architecture allows stability with ceramic capacitors of 10 μF or greater. Transient response is also superior to PMOS topologies, particularly for low V_{IN} applications.

A programmable voltage-controlled, soft-start circuit provides a smooth, monotonic start-up and limits start-up inrush currents that can be caused by large capacitive loads. An enable (EN) pin with hysteresis and deglitch allows slow-ramping signals to be used for sequencing the device. The low V_{IN} and V_{OUT} capability allows for inexpensive, easy-to-design, and efficient linear regulation between the multiple supply voltages often required by processor-intensive systems.

8.1.1 Adjusting the Output Voltage

图 8-1 shows the typical application circuit for the adjustable output device.



图 8-1. Typical Application Circuit for the TPS7A74 (Adjustable)

R_1 and R_2 can be calculated for any output voltage using the formula shown in 图 8-1. 表 8-1 lists sample resistor values of common output voltages. In order to achieve the maximum accuracy specifications, R_2 must be $\leq 4.99 \text{ k}\Omega$.

表 8-1. Standard 1% Resistor Values for Programming the Output Voltage⁽¹⁾

R ₁ (kΩ)	R ₂ (kΩ)	Targeted V _{OUT} (V)
Short	Open	0.65
0.768	4.99	0.75
2.43	4.53	1.00
2.72	4.42	1.05
3.48	4.99	1.10
4.22	4.99	1.20
4.99	3.83	1.50
4.99	2.80	1.80
4.99	1.74	2.51
4.99	1.21	3.33

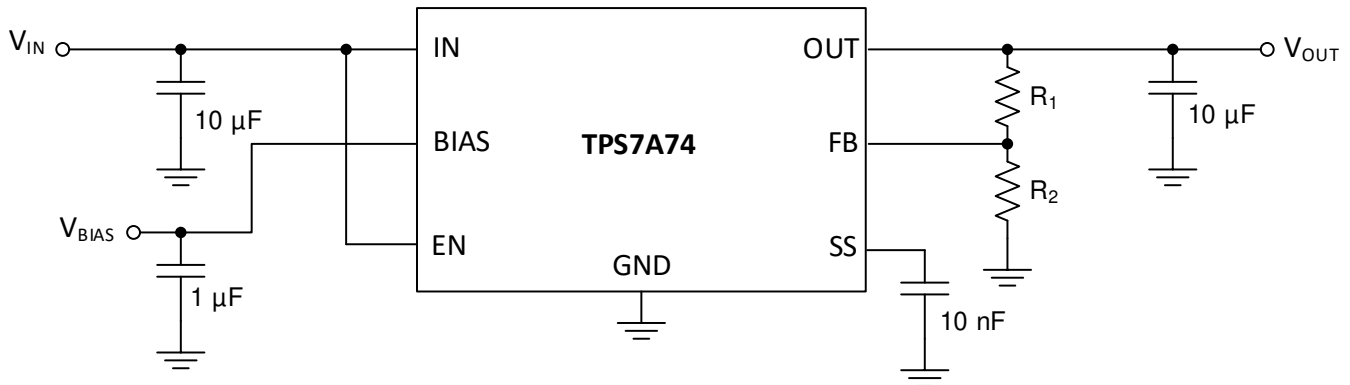
$$(1) \quad V_{OUT} = 0.65 \times (1 + R_1 / R_2).$$

备注

When V_{BIAS} and V_{EN} are present and V_{IN} is not supplied, this device outputs approximately 50 μA of current from OUT. Although this condition does not cause any damage to the device, the output current can charge the OUT node if total resistance between OUT and GND (including external feedback resistors) is greater than 10 kΩ.

Because this LDO has a relatively low quiescent current of 50 μA, some applications may benefit from using larger R₁ and R₂ resistor values. In such cases where resistor values greater than 5 kΩ are considered, adding a C_{ff} capacitor across R₁ may help improve stability.

8.1.2 Input, Output, and Bias Capacitor Requirements

The device is designed to be stable for ceramic capacitor of values $\geq 10 \mu\text{F}$. The device is also stable with multiple capacitors in parallel, which can be of any type or value.

The capacitance required on the IN and BIAS pins strongly depends on the input supply source impedance. To counteract any inductance in the input, the minimum recommended capacitor for V_{IN} is 1 μF and the minimum recommended capacitor for V_{BIAS} is 0.1 μF. If V_{IN} and V_{BIAS} are connected to the same supply, the recommended minimum capacitor for V_{BIAS} is 4.7 μF. Use good quality, low equivalent series resistance (ESR) and equivalent series inductance (ESL) capacitors on the input; ceramic X5R and X7R capacitors are preferred. Place these capacitors as close the pins as possible for optimum performance.

Low ESR and ESL capacitors improve high-frequency PSRR.

8.1.3 Transient Response

The TPS7A74 is designed to have excellent transient response for most applications with a small amount of output capacitance. In some cases, the transient response can be limited by the transient response of the input supply. This limitation is especially true in applications where the difference between the input and output is less than 300 mV. In this case, adding additional input capacitance improves the transient response more than just adding additional output capacitance. With a solid input supply, adding additional output capacitance reduces undershoot and overshoot during a transient event; see 图 6-10 in the *Typical Characteristics* section. Because the TPS7A74 is stable with output capacitors as low as 10 μF, many applications may then need very little capacitance at the LDO output. For these applications, local bypass capacitance for the powered device may be sufficient to meet the transient requirements of the application. This design reduces the total solution cost by avoiding the need to use expensive, high-value capacitors at the LDO output.

8.1.4 Dropout Voltage

The TPS7A74 offers very low dropout performance, making the device well-suited for high-current, low V_{IN} and low V_{OUT} applications. The low dropout allows the device to be used in place of a dc/dc converter and still achieve good efficiency. 方程式 6 provides a quick estimate of the efficiency.

$$\text{Efficiency} \approx \frac{V_{OUT} \times I_{OUT}}{V_{IN} \times (I_{IN} + I_Q)} \approx \frac{V_{OUT}}{V_{IN}} \text{ at } I_{OUT} \gg I_Q \quad (6)$$

This efficiency provides designers with the power architecture for their applications to achieve the smallest, simplest, and lowest cost solutions.

For this architecture, there are two different specifications for dropout voltage. The first specification (see 图 8-2) is referred to as V_{IN} dropout and is used when an external bias voltage is applied to achieve low dropout. This specification assumes that V_{BIAS} is at least 2.8 V above V_{OUT} , which is the case for V_{BIAS} when powered by a 5.0-V rail with 5% tolerance and with $V_{OUT} = 1.5$ V. If V_{BIAS} is higher than $V_{OUT} + 2.8$ V, the V_{IN} dropout is less than specified.

备注

2.8 V is a test condition of this device and can be adjusted by referring to the [Electrical Characteristics](#) table.

The second specification (illustrated in 图 8-2) is referred to as V_{BIAS} dropout and applies to applications where IN and BIAS are tied together. This option allows the device to be used in applications where an auxiliary bias voltage is not available or low dropout is not required. Dropout is limited by BIAS in these applications because V_{BIAS} provides the gate drive to the pass transistor; therefore, V_{BIAS} must be 1.3 V above V_{OUT} . Because of this usage, having IN and BIAS tied together become a highly inefficient solution that can consume large amounts of power. Pay attention not to exceed the power rating of the device package.

8.1.5 Output Noise

The TPS7A74 provides low output noise when a soft-start capacitor is used. When the device reaches the end of the soft-start cycle, the soft-start capacitor serves as a filter for the internal reference. By using a 1-nF, soft-start capacitor, the output noise is reduced by half and is typically $7.1 \mu V_{RMS}$ for a 0.65-V output (10 Hz to 100 kHz). Further increasing C_{SS} has little effect on noise. Because most of the output noise is generated by the internal reference, the noise is a function of the set output voltage. 方程式 7 gives the RMS noise with a 1-nF, soft-start capacitor:

$$V_N(\mu V_{RMS}) = 7.1 \cdot \left(\frac{\mu V_{RMS}}{V} \right) \cdot V_{OUT}(V) \quad (7)$$

The low output noise makes this LDO a good choice for powering transceivers, phase-locked loops (PLLs), or other noise-sensitive circuitry.

8.1.6 Estimating Junction Temperature

By using the thermal metrics Ψ_{JT} and Ψ_{JB} , as shown in the [Thermal Information](#) table, the junction temperature can be estimated with corresponding formulas (given in [方程式 8](#)). For backwards compatibility, an older $\theta_{JC(top)}$ parameter is listed as well.

$$\begin{aligned} \Psi_{JT}: T_J &= T_T + \Psi_{JT} \cdot P_D \\ \Psi_{JB}: T_J &= T_B + \Psi_{JB} \cdot P_D \end{aligned} \quad (8)$$

Where P_D is the power dissipation shown by [方程式 9](#), T_T is the temperature at the center-top of the package, and T_B is the PCB temperature measured 1 mm away from the package *on the PCB surface*.

备注

Both T_T and T_B can be measured on actual application boards using a thermo-gun (an infrared thermometer).

For more information about measuring T_T and T_B , see the [Using New Thermal Metrics application note](#), available for download at www.ti.com.

For a more detailed discussion of why TI does not recommend using $\theta_{JC(top)}$ to determine thermal characteristics, see the [Using New Thermal Metrics application note](#), available for download at www.ti.com. For further information, see the [Semiconductor and IC Package Thermal Metrics application note](#), also available on the TI website.

8.2 Typical Application

8.2.1 FPGA I/O Supply at 1.8 V With a Bias Rail



图 8-2. Typical Application Using an Auxiliary Bias Rail

8.2.1.1 Design Requirements

This application powers the I/O rails of an FPGA, at $V_{OUT(nom)} = 1.8\text{ V}$ and $I_{OUT(dc)} = 1.5\text{ A}$. The available external supply voltages are 2.1 V, 3.3 V, and 5 V.

表 8-2 lists the parameters for this design example.

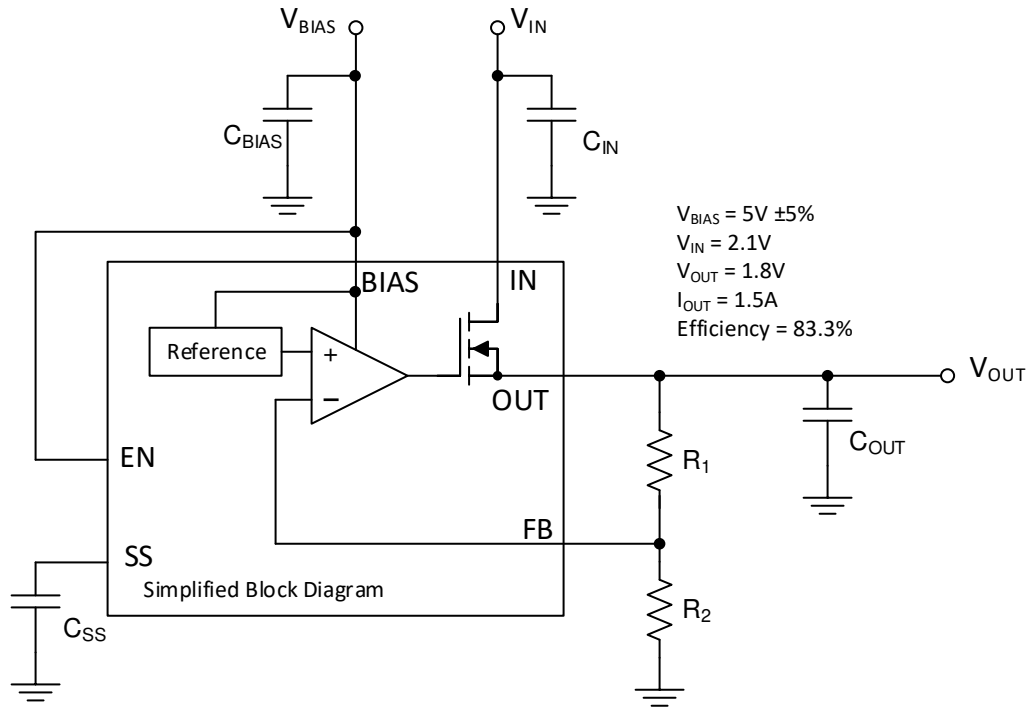
表 8-2. Design Parameters

DESIGN PARAMETER	EXAMPLE VALUE
V_{IN}	2.1 V
V_{BIAS}	2.4 V to 5.5 V
V_{OUT}	1.8 V
I_{OUT}	600 mA (typical), 900 mA (peak)

8.2.1.2 Detailed Design Procedure

First, determine what supplies to use for the input and bias rails. A 2.1-V input can be stepped down to 1.5 V at 1.5 A if an external bias is provided, because the maximum dropout voltage is 180 mV if V_{BIAS} is at least 2.8 V higher than V_{OUT} . To achieve this voltage step, the bias rail is supplied by the 5-V supply. The approximation in 方程式 6 estimates the efficiency at 83.3%.

The output voltage then must be set to 1.5 V. As 表 8-1 describes, set $R_1 = 4.99\text{ k}\Omega$ and $R_2 = 3.82\text{ k}\Omega$ to obtain the required output voltage. The minimum capacitor sizing requires the total solution size footprint to be reduced; see the [Input, Output, and Bias Capacitor Requirements](#) section for $C_{IN} = 1\text{ }\mu\text{F}$, $C_{BIAS} = 1\text{ }\mu\text{F}$, and $C_{OUT} = 2.2\text{ }\mu\text{F}$. Use $C_{SS} = 1\text{ nF}$ for a typical 0.032-ms start-up time.

图 8-2 shows a simplified version of the final circuit.

8.2.1.3 Application Curves

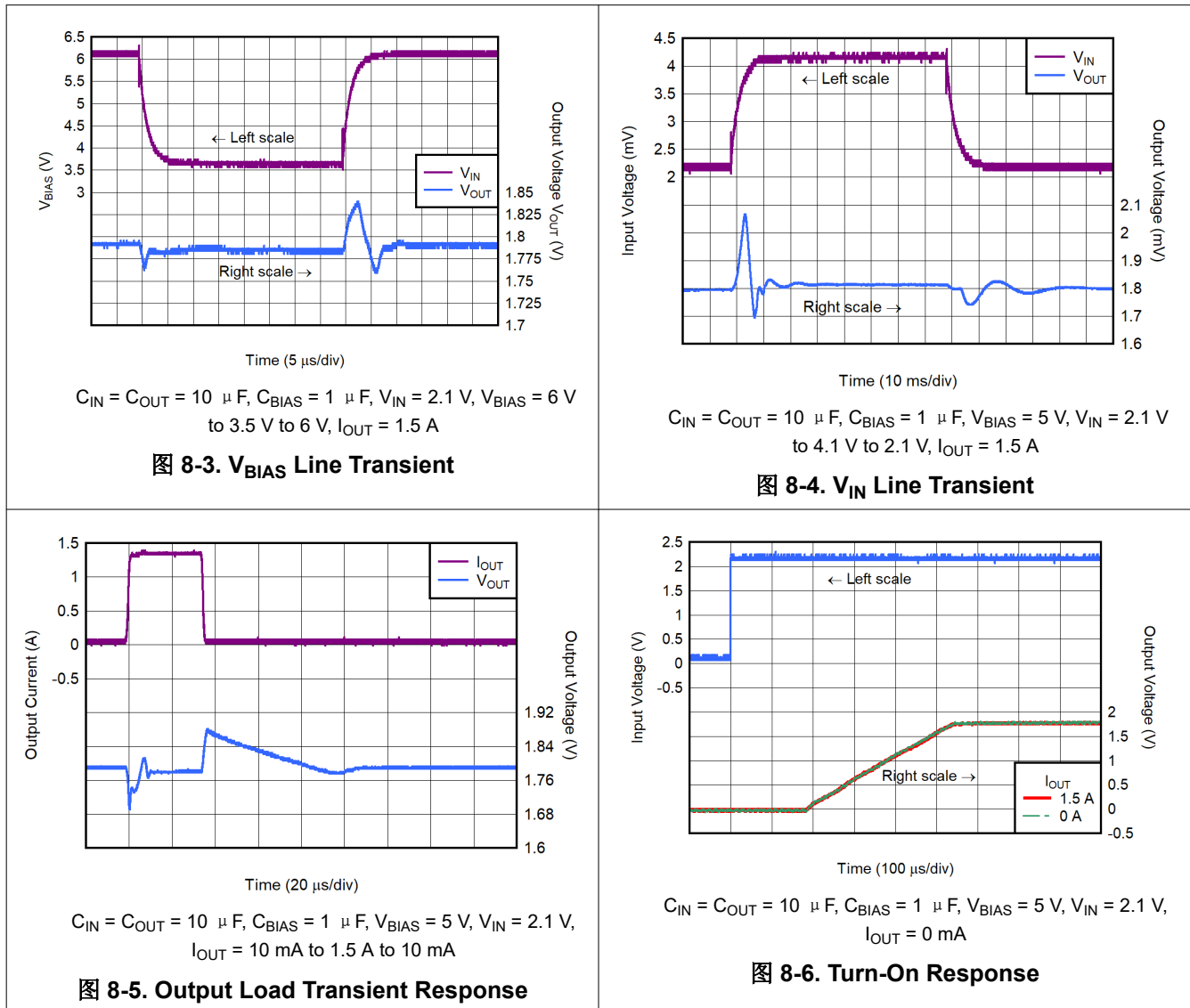

8.3 Power Supply Recommendations

The TPS7A74 is designed to operate from an input voltage up to 6.0 V, provided the bias rail is at least 1.3 V higher than the input supply and dropout requirements are met. The bias rail and the input supply must both provide adequate headroom and current for the device to operate normally. Connect a low output impedance power supply directly to the IN pin. This supply must have at least 1 μF of capacitance near the IN pin for optimal performance. A supply with similar requirements must also be connected directly to the bias rail with a separate 1 μF or larger capacitor. If the IN pin is tied to the bias pin, a minimum 4.7-μF capacitor is required for performance. To increase the overall PSRR of the solution at higher frequencies, use a pi-filter or ferrite bead before the input capacitor.

8.4 Layout

8.4.1 Layout Guidelines

An optimal layout can greatly improve transient performance, PSRR, and noise. To minimize the voltage drop on the input of the device during load transients, the capacitance on IN and BIAS must be connected as close as possible to the device. This capacitance also minimizes the effects of parasitic inductance and resistance of the input source and can, therefore, improve stability. To achieve optimal transient performance and accuracy, the top side of R₁ in [图 8-1](#) must be connected as close as possible to the load. If BIAS is connected to IN, connect BIAS as close to the sense point of the input supply as possible. This connection minimizes the voltage drop on BIAS during transient conditions and can improve the turn-on response.

Knowing the device power dissipation and proper sizing of the thermal plane that is connected to the thermal pad is critical to avoiding thermal shutdown and ensuring reliable operation. Power dissipation (P_D) of the device depends on input voltage and load conditions. [方程式 9](#) calculates P_D.

$$P_D = (V_{IN} - V_{OUT}) \times I_{OUT} \quad (9)$$

Power dissipation can be minimized and greater efficiency can be achieved by using the lowest possible input voltage necessary to achieve the required output voltage regulation.

On the WSON (DSD) package, the primary conduction path for heat is through the exposed pad to the printed circuit board (PCB). The pad can be connected to ground or left floating; however, this pad must be attached to an appropriate amount of copper PCB area to ensure the device does not overheat. The maximum junction-to-ambient thermal resistance depends on the maximum ambient temperature, maximum device junction temperature, and power dissipation of the device. [方程式 10](#) calculates the maximum junction-to-ambient thermal resistance.

$$R_{\theta JA} = \frac{(+125^{\circ}\text{C} - T_A)}{P_D} \quad (10)$$

备注

When the device is mounted on an application PCB, TI strongly recommends using Ψ_{JT} and Ψ_{JB} , as explained in the [Estimating Junction Temperature](#) section.

8.4.1.1 Estimating Junction Temperature

By using the thermal metrics Ψ_{JT} and Ψ_{JB} , as shown in the [Thermal Information](#) table, the junction temperature can be estimated with corresponding formulas (given in [方程式 11](#)). For backwards compatibility, an older $\theta_{JC(top)}$ parameter is listed as well.

$$\begin{aligned} \Psi_{JT}: T_J &= T_T + \Psi_{JT} \cdot P_D \\ \Psi_{JB}: T_J &= T_B + \Psi_{JB} \cdot P_D \end{aligned} \tag{11}$$

Where P_D is the power dissipation shown by [方程式 9](#), T_T is the temperature at the center-top of the package, and T_B is the PCB temperature measured 1 mm away from the package *on the PCB surface*.

备注

Both T_T and T_B can be measured on actual application boards using a thermo-gun (an infrared thermometer).

For more information about measuring T_T and T_B , see the [Using New Thermal Metrics application note](#), available for download at www.ti.com.

For a more detailed discussion of why TI does not recommend using $\theta_{JC(top)}$ to determine thermal characteristics, see the [Using New Thermal Metrics application note](#), available for download at www.ti.com. For further information, see the [Semiconductor and IC Package Thermal Metrics application note](#), also available on the TI website.

8.4.2 Layout Example



图 8-7. Example Layout (DSD Package)

9 Device and Documentation Support

9.1 Device Support

9.1.1 Development Support

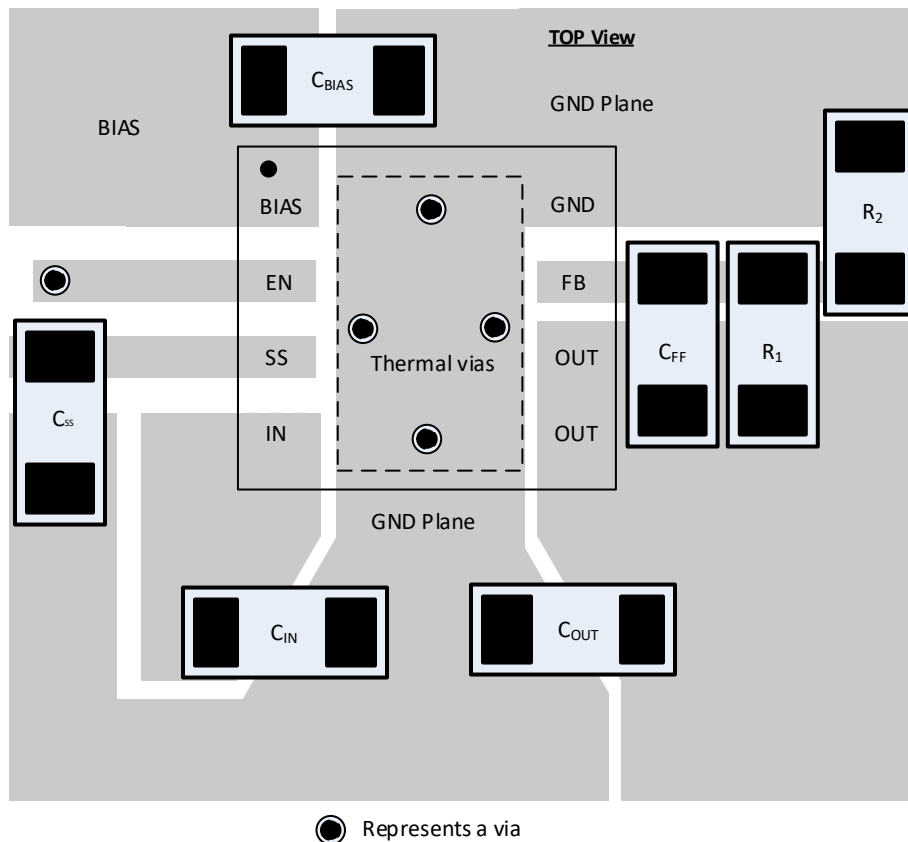
9.1.1.1 Evaluation Modules

An evaluation module (EVM) is available to assist in the initial circuit performance evaluation using the TPS7A74. The evaluation module (and related user guide user's guide) can be requested at the Texas Instruments website through the product folders or purchased directly from the [TI eStore](#).

9.1.1.2 Spice Models

Computer simulation of circuit performance using SPICE is often useful when analyzing the performance of analog circuits and systems. A SPICE model for the TPS7A74 is available through the product folders under *Tools & Software*.

9.2 Documentation Support

9.2.1 Related Documentation

For related documentation, see the following:

- Texas Instruments, [Using New Thermal Metrics application note](#)
- Texas Instruments, [Semiconductor and IC Package Thermal Metrics application note](#)
- Texas Instruments, [Ultimate Regulation with Fixed Output Versions of TPS742xx, TPS743xx, and TPS744xx application note](#)
- Texas Instruments, [Pros and Cons of Using a Feed-Forward Capacitor with a Low Dropout Regulator application note](#)
- Texas Instruments, [TPS74701EVM-177 and TPS74801EVM-177 user's guide](#)

9.3 接收文档更新通知

要接收文档更新通知，请导航至 [ti.com](#) 上的器件产品文件夹。点击 [订阅更新](#) 进行注册，即可每周接收产品信息更改摘要。有关更改的详细信息，请查看任何已修订文档中包含的修订历史记录。

9.4 支持资源

[TI E2E™ 支持论坛](#) 是工程师的重要参考资料，可直接从专家获得快速、经过验证的解答和设计帮助。搜索现有解答或提出自己的问题可获得所需的快速设计帮助。

链接的内容由各个贡献者“按原样”提供。这些内容并不构成 TI 技术规范，并且不一定反映 TI 的观点；请参阅 TI 的 [《使用条款》](#)。

9.5 Trademarks

TI E2E™ is a trademark of Texas Instruments.

所有商标均为其各自所有者的财产。

9.6 Electrostatic Discharge Caution



This integrated circuit can be damaged by ESD. Texas Instruments recommends that all integrated circuits be handled with appropriate precautions. Failure to observe proper handling and installation procedures can cause damage.

ESD damage can range from subtle performance degradation to complete device failure. Precision integrated circuits may be more susceptible to damage because very small parametric changes could cause the device not to meet its published specifications.

9.7 术语表

[TI 术语表](#) 本术语表列出并解释了术语、首字母缩略词和定义。

10 Mechanical, Packaging, and Orderable Information

The following pages include mechanical, packaging, and orderable information. This information is the most current data available for the designated devices. This data is subject to change without notice and revision of this document. For browser-based versions of this data sheet, refer to the left-hand navigation.

PACKAGING INFORMATION

Orderable Device	Status (1)	Package Type	Package Drawing	Pins	Package Qty	Eco Plan (2)	Lead finish/ Ball material (6)	MSL Peak Temp (3)	Op Temp (°C)	Device Marking (4/5)	Samples
TPS7A7401DSDR	ACTIVE	SON	DSD	8	5000	RoHS & Green	NIPDAU	Level-2-260C-1 YEAR	-40 to 125	7A7401	Samples

(1) The marketing status values are defined as follows:

ACTIVE: Product device recommended for new designs.

LIFEBUY: TI has announced that the device will be discontinued, and a lifetime-buy period is in effect.

NRND: Not recommended for new designs. Device is in production to support existing customers, but TI does not recommend using this part in a new design.

PREVIEW: Device has been announced but is not in production. Samples may or may not be available.

OBSELETE: TI has discontinued the production of the device.

(2) **RoHS:** TI defines "RoHS" to mean semiconductor products that are compliant with the current EU RoHS requirements for all 10 RoHS substances, including the requirement that RoHS substance do not exceed 0.1% by weight in homogeneous materials. Where designed to be soldered at high temperatures, "RoHS" products are suitable for use in specified lead-free processes. TI may reference these types of products as "Pb-Free".

RoHS Exempt: TI defines "RoHS Exempt" to mean products that contain lead but are compliant with EU RoHS pursuant to a specific EU RoHS exemption.

Green: TI defines "Green" to mean the content of Chlorine (Cl) and Bromine (Br) based flame retardants meet JS709B low halogen requirements of <=1000ppm threshold. Antimony trioxide based flame retardants must also meet the <=1000ppm threshold requirement.

(3) MSL, Peak Temp. - The Moisture Sensitivity Level rating according to the JEDEC industry standard classifications, and peak solder temperature.

(4) There may be additional marking, which relates to the logo, the lot trace code information, or the environmental category on the device.

(5) Multiple Device Markings will be inside parentheses. Only one Device Marking contained in parentheses and separated by a "-" will appear on a device. If a line is indented then it is a continuation of the previous line and the two combined represent the entire Device Marking for that device.

(6) Lead finish/Ball material - Orderable Devices may have multiple material finish options. Finish options are separated by a vertical ruled line. Lead finish/Ball material values may wrap to two lines if the finish value exceeds the maximum column width.

Important Information and Disclaimer:The information provided on this page represents TI's knowledge and belief as of the date that it is provided. TI bases its knowledge and belief on information provided by third parties, and makes no representation or warranty as to the accuracy of such information. Efforts are underway to better integrate information from third parties. TI has taken and continues to take reasonable steps to provide representative and accurate information but may not have conducted destructive testing or chemical analysis on incoming materials and chemicals. TI and TI suppliers consider certain information to be proprietary, and thus CAS numbers and other limited information may not be available for release.

In no event shall TI's liability arising out of such information exceed the total purchase price of the TI part(s) at issue in this document sold by TI to Customer on an annual basis.

TAPE AND REEL INFORMATION

QUADRANT ASSIGNMENTS FOR PIN 1 ORIENTATION IN TAPE

*All dimensions are nominal

Device	Package Type	Package Drawing	Pins	SPQ	Reel Diameter (mm)	Reel Width W1 (mm)	A0 (mm)	B0 (mm)	K0 (mm)	P1 (mm)	W (mm)	Pin1 Quadrant
TPS7A7401DSDR	SON	DSD	8	5000	330.0	12.4	3.3	3.3	1.1	8.0	12.0	Q2

TAPE AND REEL BOX DIMENSIONS

*All dimensions are nominal

Device	Package Type	Package Drawing	Pins	SPQ	Length (mm)	Width (mm)	Height (mm)
TPS7A7401DSDR	SON	DSD	8	5000	367.0	367.0	35.0

GENERIC PACKAGE VIEW

DSD 8

WSON - 0.8 mm max height

3 X 3, 0.8 mm pitch

PLASTIC QUAD FLATPACK - NO LEAD

This image is a representation of the package family, actual package may vary.
Refer to the product data sheet for package details.

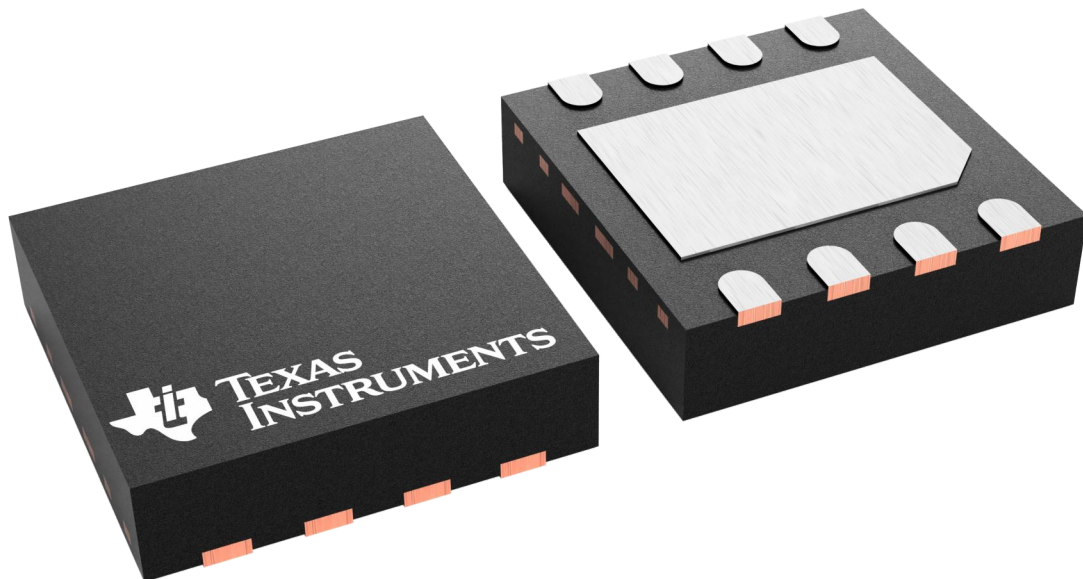

4227007/A

DSD0008B

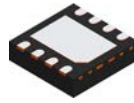

PACKAGE OUTLINE

WSON - 0.8 mm max height

PLASTIC SMALL OUTLINE - NO LEAD

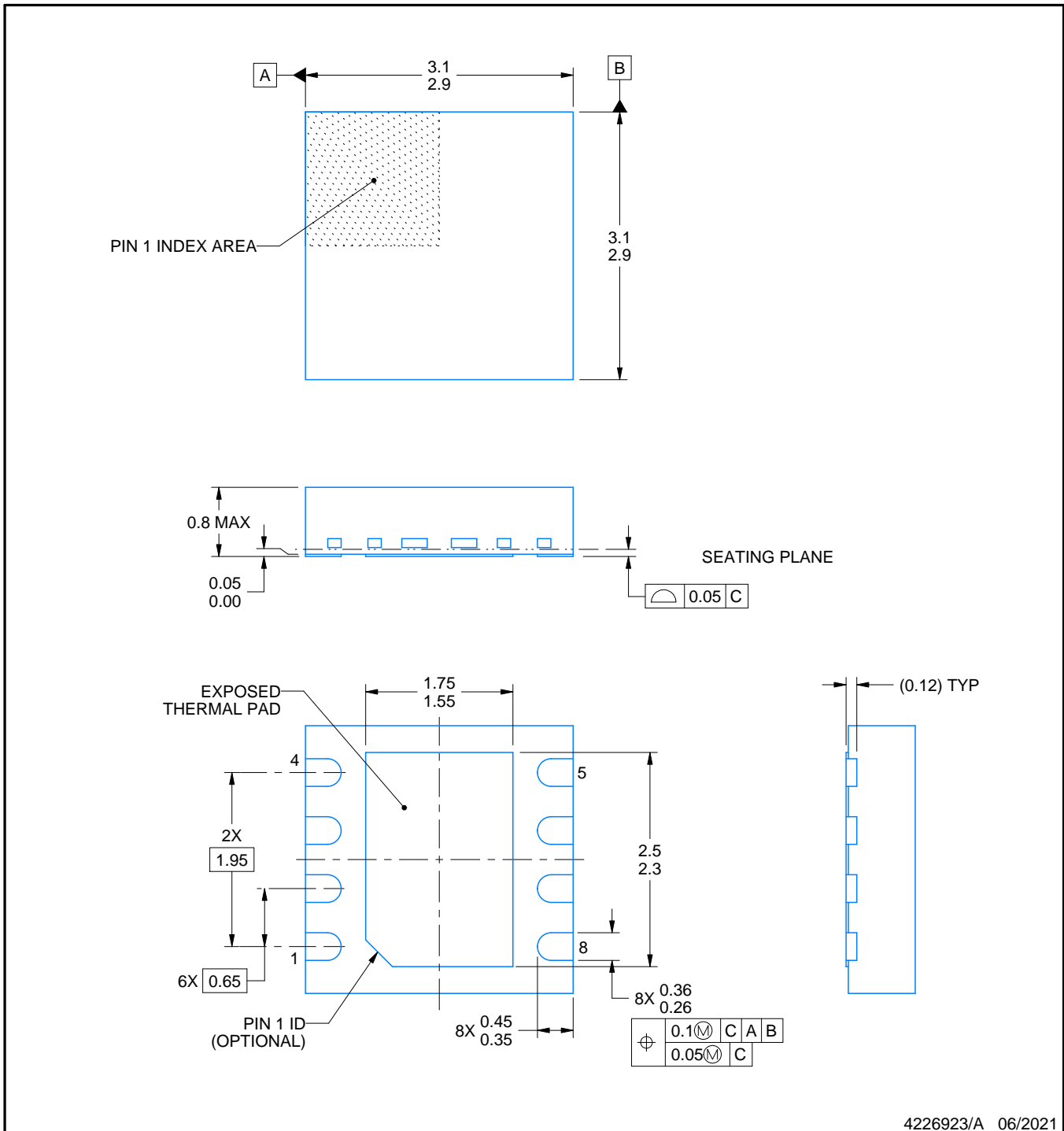

4226923/A 06/2021

NOTES:

1. All linear dimensions are in millimeters. Any dimensions in parenthesis are for reference only. Dimensioning and tolerancing per ASME Y14.5M.
2. This drawing is subject to change without notice.
3. The package thermal pad must be soldered to the printed circuit board for thermal and mechanical performance.

EXAMPLE BOARD LAYOUT

DSD0008B

WSON - 0.8 mm max height

PLASTIC SMALL OUTLINE - NO LEAD

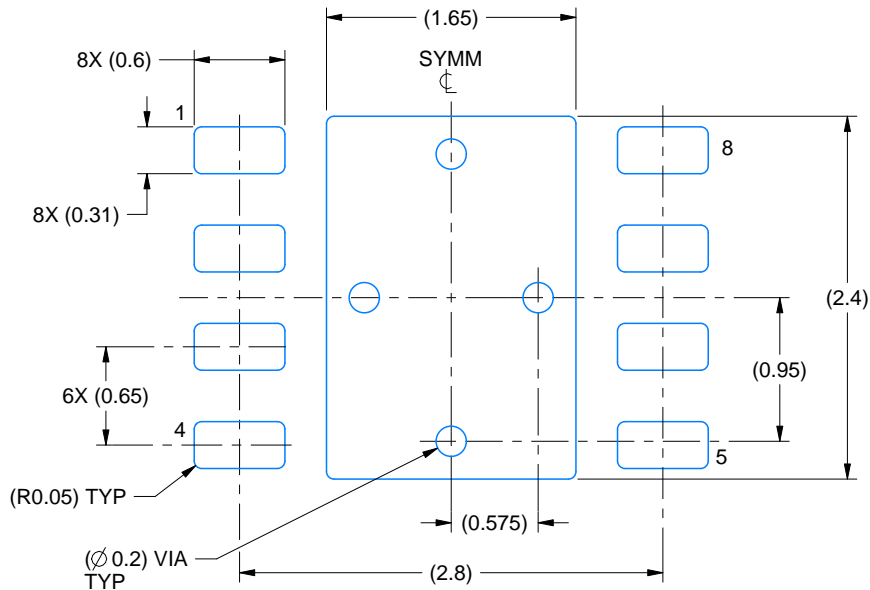

LAND PATTERN EXAMPLE
SCALE:20X

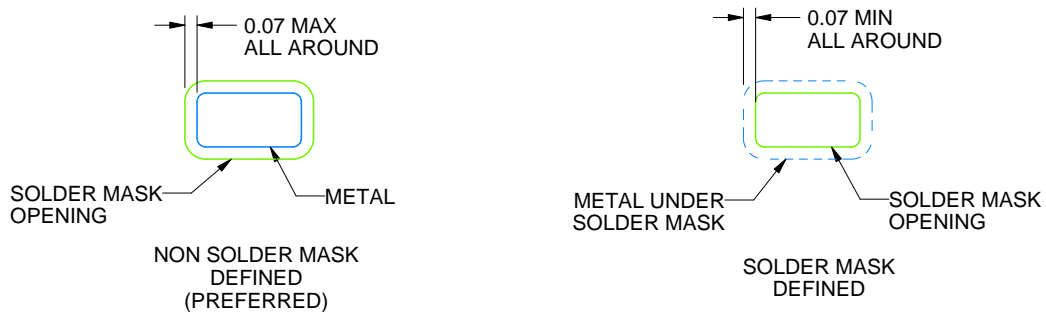

SOLDER MASK DETAILS

4226923/A 06/2021

NOTES: (continued)

4. This package is designed to be soldered to a thermal pad on the board. For more information, see Texas Instruments literature number SLUA271 (www.ti.com/lit/slua271).
5. Vias are optional depending on application, refer to device data sheet. If any vias are implemented, refer to their locations shown on this view. It is recommended that vias under paste be filled, plugged or tented.

EXAMPLE STENCIL DESIGN

DSD0008B

WSON - 0.8 mm max height

PLASTIC SMALL OUTLINE - NO LEAD

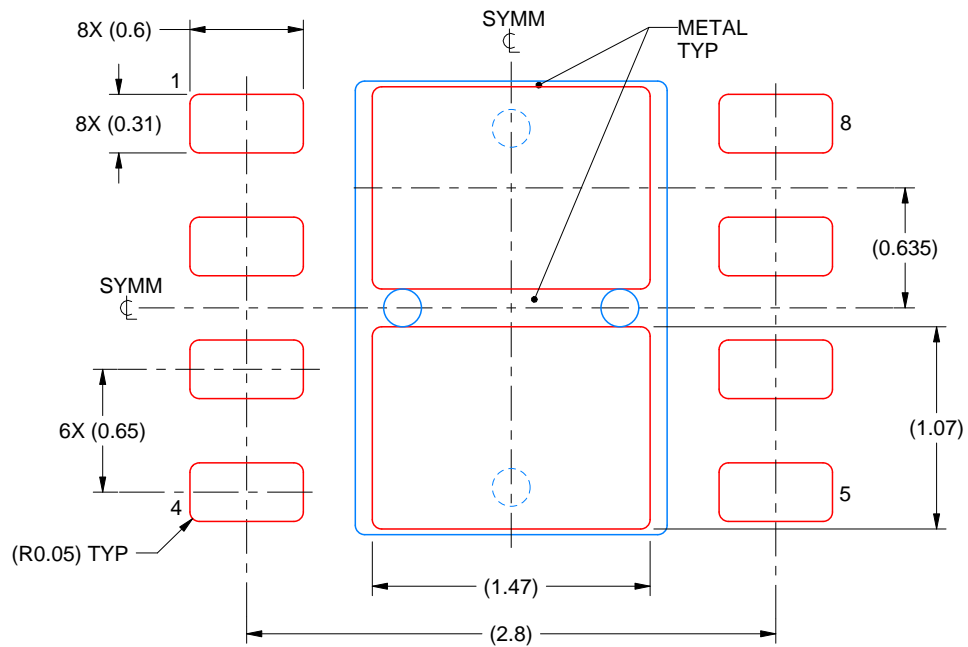

SOLDER PASTE EXAMPLE
BASED ON 0.125 mm THICK STENCIL
EXPOSED PAD
82% PRINTED SOLDER COVERAGE BY AREA
SCALE:25X

4226923/A 06/2021

NOTES: (continued)

6. Laser cutting apertures with trapezoidal walls and rounded corners may offer better paste release. IPC-7525 may have alternate design recommendations.

重要声明和免责声明

TI“按原样”提供技术和可靠性数据（包括数据表）、设计资源（包括参考设计）、应用或其他设计建议、网络工具、安全信息和其他资源，不保证没有瑕疵且不做任何明示或暗示的担保，包括但不限于对适销性、某特定用途方面的适用性或不侵犯任何第三方知识产权的暗示担保。

这些资源可供使用 TI 产品进行设计的熟练开发人员使用。您将自行承担以下全部责任：(1) 针对您的应用选择合适的 TI 产品，(2) 设计、验证并测试您的应用，(3) 确保您的应用满足相应标准以及任何其他功能安全、信息安全、监管或其他要求。

这些资源如有变更，恕不另行通知。TI 授权您仅可将这些资源用于研发本资源所述的 TI 产品的应用。严禁对这些资源进行其他复制或展示。您无权使用任何其他 TI 知识产权或任何第三方知识产权。您应全额赔偿因在这些资源的使用中对 TI 及其代表造成的任何索赔、损害、成本、损失和债务，TI 对此概不负责。

TI 提供的产品受 [TI 的销售条款](#) 或 [ti.com](#) 上其他适用条款/TI 产品随附的其他适用条款的约束。TI 提供这些资源并不会扩展或以其他方式更改 TI 针对 TI 产品发布的适用的担保或担保免责声明。

TI 反对并拒绝您可能提出的任何其他或不同的条款。

邮寄地址：Texas Instruments, Post Office Box 655303, Dallas, Texas 75265

Copyright © 2022，德州仪器 (TI) 公司